

K-TOOL INTERNATIONAL

Wixom, MI 48393

www.ktoolinternational.com

Part No. KTICAT



Serving the Automotive Industry Since 1984

2016

K-TOOL INTERNATIONAL 2016



PROFESSIONAL TOOLS & EQUIPMENT



2016

HEAVYWEIGHT QUALITY. KNOCKOUT PRICE.



TABLE OF CONTENTS

Hand Tools 4-53

Chrome Sockets, Impact Sockets, Spline Sockets, Crowsfoot, Torx Sockets (internal /external), Flip Sockets, Spindle Nut Sockets, Hex Bit Sockets, Spark Plug Sockets, Universal Joints, Adapters, Reducers, Extensions, Ratchets, Breaker Bars, T-handles, Spinner Handles, Standard and Professional Series Screwdrivers, Torq Screwdrivers, Nut Drivers, Hex Bits, Pry Bars (bent head, rolling head), Files, Taper Punches, Center Punches, Pin Punches, Chisel, and Brass Punches, Raised Panel Combination, High Polish Combination, Stubby, Flare Nut, Ratcheting Box, Ratcheting Combination and Reversible Ratcheting, Adjustable Wrenches, Pipe Wrenches, Aluminum Pipe Wrenches, Allen/Hex Wrenches, Needle Nose, Diagonal, Slip Joint, Groove Joint, Locking, Snap Ring Pliers, Ball Pein Hammers, Claw Hammer, Rubber Mallet, Brass Hammers, Tape Measures

Tool Storage 54-59

Service Carts, Creepers, Creeper Seats, Magnetic Tool Storage and Organization

Lighting..... 60-69

Hand Held, Work Lights, Work Light Accessories, Extension Cords and Reels

Cutting/Threading/Abrasives 70-77

Drill Bits, Extractors, Knives, Utility Knives, Scrapers, Tube Cutters, Tube Benders, Bolt Cutters, Tin Snips, Hack Saws, Cut-Off Wheels, Wire Wheel and Cup Brushes, Utility Brushes

Air Tools & Electric Tools 78-95

Ratchets, Impact Wrenches, Drills, Hammers, Air Tool Accessories, Die Grinders, Sanders and Polishers, Sanders and Polishers Accessories, Blow Guns, Scalars, Cut-Off Tools, Rivet Guns, Air Hoses, Grinders

Shop Tools 96-133

Bottle Jacks, Service Jacks, Transmission Jacks, Jack Stands, Underhoist Stands, Engine Stands, Support Bars and Slings, Ram Kits, Shop Presses, Creepers, Stools & Fender Covers, Material Handling, Tow Straps, Recovery Ropes, Tie Downs and Straps, Nylon Ties, Heating, Welding & Soldering, TPMS Tools & Accessories, Hoses, Cleaning Supplies, Adhesives & Tapes, Fluids and Grease

Battery Testers & Booster Cables 134-139

Battery Testers, Booster Cables, Clamps

Vehicle Specialty 140-189

Flaring Tools, Brake Tools, Fittings and Accessories, Tire and Wheel Tools, Steering & Suspension Tools and Fittings, Drive Shaft & Axle Tools, Oil Filter Wrenches and Accessories, Vacuum Caps, Pullers, Fittings and Accessories, Tubing, Cutting & Bending Tools, Inspection Tools, Fuel System Tools and Fittings, Electrical Tools, Fuses, and Connectors, Strippers, Crimpers, Circuit Testers

Paint & Body Tools 190-193

Spray Guns, Regulators and Filters, Clip Removers, Riveters, Impact Drivers, Wedges

Displays 194-223

Wall, Floor, Counter Displays, Hooks, Hangers, Display Boards













Index by Part Number 224-234

Index by Category 235-239

Warranty Information 240-241

Safety Information.....242

Icon Legend

- Product is proudly made in the USA
- Product is 1/4-inch drive
- Product is 3/8-inch drive
- Product is 1/2-inch drive
- Product is 3/4-inch drive
- Product is 1-inch drive
- Product has 6 internal points of contact
- Product has 12 internal points of contact
- Repair or replacement parts are available
- Product is also sold individually
- Product is covered by lifetime warranty (does not cover case, containers etc) - Does not cover abuse.
- Oversized product ships via freight company
- Sets & Kits are not covered by warranty; See individual pieces for warranty.



Notes





HEAVYWEIGHT QUALITY. KNOCKOUT PRICE.



TAKE THE K-TOOL KO CHALLENGE!

Get the "K-TOOL KO Challenge Kit" . . .

And give your customers a ringside for the "K-TOOL KO Challenge" – a 5/8" wrench from Snap-On (we'll call the champion, for now), the second place competitor of the time, and of course ours (currently, the contender). It's simple. Look at them. Same quality. Same functionality. Feel them. Some will say the Snap-On feels better in their hands. But the difference, they will admit is small. The price difference, however is big. K-TOOL is substantially lower. It is rare for someone with a ringside seat to put their money anywhere, but on the challenger – K-TOOL. What can we say, that's who we are. We're not champions yet, but we're giving the competition a helluva beating. Call your K-TOOL rep today and get your "K-TOOL KO Challenge Kit." And give your retailers a ringside seat.



HAND TOOLS



1.800.762.6002 | www.ktoolinternational.com

1/4" Drive Chrome | Complete Sets 1/4"

KTI21044

44-piece Fractional and Metric 6-point Socket Set 1/4" Drive

• Chrome vanadium, heat-treated, packaged in blow molded case
Includes a 1/4" drive pro ratchet, 2" extension, 6" extension, standard length fractional sockets 3/16" to 9/16", deep fractional sockets 1/4" to 9/16", standard length metric sockets from 4mm to 15mm, deep metric sockets 6mm to 15mm.



LIFETIME WARRANTY*



Set includes (also available individually):

KTI21106 - 3/16"
KTI21107 - 7/32"
KTI21108 - 1/4"
KTI21109 - 9/32"
KTI21110 - 5/16"
KTI21111 - 11/32"
KTI21112 - 3/8"
KTI21114 - 7/16"
KTI21116 - 1/2"

KTI21118 - 9/16"
KTI21208 - 1/4" deep
KTI21209 - 9/32" deep
KTI21210 - 5/16" deep
KTI21211 - 11/32" deep
KTI21212 - 3/8" deep
KTI21214 - 7/16" deep
KTI21216 - 1/2" deep
KTI21218 - 9/16" deep

KTI26104 - 4mm
KTI26105 - 5mm
KTI26155 - 5.5mm
KTI26106 - 6mm
KTI26107 - 7mm
KTI26108 - 8mm
KTI26109 - 9mm
KTI26110 - 10mm
KTI26111 - 11mm

KTI26112 - 12mm
KTI26113 - 13mm
KTI26114 - 14mm
KTI26115 - 15mm
KTI26206 - 6mm deep
KTI26207 - 7mm deep
KTI26208 - 8mm deep
KTI26209 - 9mm deep
KTI26210 - 10mm deep

KTI26211 - 11mm deep
KTI26212 - 12mm deep
KTI26213 - 13mm deep
KTI26214 - 14mm deep
KTI26215 - 15mm deep
KTI21092 - Ratchet
KTI21002 - 2" Extension
KTI21006 - 6" Extension



LIFETIME WARRANTY*

KTI21000

21-Piece Fractional 6-point Socket Set 1/4" Drive

• All sockets are 6-point chrome vanadium
• Packaged blow-molded case
Includes 9 short sockets from 3/16" to 1/2", 7 deep sockets from 1/4" to 1/2", push button ratchet, universal joint, 2" and 4" extensions and spinner.



Set includes (also available individually):

KTI21106 - 3/16"
KTI21107 - 7/32"
KTI21108 - 1/4"
KTI21109 - 9/32"
KTI21110 - 5/16"
KTI21111 - 11/32"
KTI21112 - 3/8"

KTI21114 - 7/16"
KTI21116 - 1/2"
KTI21208 - 1/4" deep
KTI21209 - 9/32" deep
KTI21210 - 5/16" deep
KTI21211 - 11/32" deep
KTI21212 - 3/8" deep

KTI21214 - 7/16" deep
KTI21216 - 1/2" deep
KTI21091 - Ratchet
KTI21002 - 2" Extension
KTI21004 - 4" Extension
KTI21050 - Universal Joint
KTI21060 - Spinner Handle



LIFETIME WARRANTY*

KTI26000

21-Piece Metric 6-point Socket Set 1/4" Drive

• 6-point chrome vanadium steel
Includes 9 short sockets from 4mm to 11mm, 7 deep sockets from 5.5mm to 11mm, push button ratchet, universal joint, 2" and 4" extensions and spinner.



Set includes (also available individually):

KTI26104 - 4mm
KTI26105 - 5mm
KTI26155 - 5.5mm
KTI26106 - 6mm
KTI26107 - 7mm
KTI26108 - 8mm
KTI26109 - 9mm

KTI26110 - 10mm
KTI26111 - 11mm
KTI26255 - 5.5mm deep
KTI26206 - 6mm deep
KTI26207 - 7mm deep
KTI26208 - 8mm deep
KTI26209 - 9mm deep

KTI26210 - 10mm deep
KTI26211 - 11mm deep
KTI21091 - Ratchet
KTI21002 - 2" Extension
KTI21004 - 4" Extension
KTI21050 - Universal Joint
KTI21060 - Spinner Handle

Open Stock 1/4"

1/4" Drive Chrome Sockets		
Fractional		
	Standard	Deep
Size	6 pt	6 pt
3/16"	KTI21106	KTI21206
7/32"	KTI21107	KTI21207
1/4"	KTI21108	KTI21208
9/32"	KTI21109	KTI21209
5/16"	KTI21110	KTI21210
11/32"	KTI21111	KTI21211
3/8"	KTI21112	KTI21212
7/16"	KTI21114	KTI21214
1/2"	KTI21116	KTI21216
9/16"	KTI21118	KTI21218

1/4" Drive Chrome Sockets		
Metric		
	Standard	Deep
Size	6 pt	6 pt
4mm	KTI26104	
5mm	KTI26105	
5.5mm	KTI26155	KTI26255
6mm	KTI26106	KTI26206
7mm	KTI26107	KTI26207
8mm	KTI26108	KTI26208
9mm	KTI26109	KTI26209
10mm	KTI26110	KTI26210
11mm	KTI26111	KTI26211
12mm	KTI26112	KTI26212
13mm	KTI26113	KTI26213
14mm	KTI26114	KTI26214
15mm	KTI26115	KTI26215



HAND TOOLS

1/4" Drive Chrome | Complete Sets 1/4"

KT121200 8-Piece Fractional 6-Point Socket Set 1/4" Drive - Deep

- 6-point sockets
- Chrome vanadium steel
- Heat-treated
- Packaged on a socket rail



Set includes (also available individually):

- | | |
|-----------------------|------------------------|
| KT121207 - 7/32" deep | KT121211 - 11/32" deep |
| KT121208 - 1/4" deep | KT121212 - 3/8" deep |
| KT121209 - 9/32" deep | KT121214 - 7/16" deep |
| KT121210 - 5/16" deep | KT121216 - 1/2" deep |

KT126200 8-Piece Metric 6-Point Socket Set 1/4" Drive - Deep

- Chrome vanadium steel
- Heat-treated
- Packaged on socket rail



Set includes (also available individually):

- | | |
|---------------------|----------------------|
| KT126206 - 6mm deep | KT126210 - 10mm deep |
| KT126207 - 7mm deep | KT126211 - 11mm deep |
| KT126208 - 8mm deep | KT126212 - 12mm deep |
| KT126209 - 9mm deep | KT126213 - 13mm deep |

KT126100 8-Piece Metric 6-Point Socket Set 1/4" Drive - Short

- 6-point sockets
- Chrome vanadium steel
- Heat-treated
- Packaged on socket rail



Set includes (also available individually):

- | | |
|----------------|-----------------|
| KT126106 - 6mm | KT126110 - 10mm |
| KT126107 - 7mm | KT126111 - 11mm |
| KT126108 - 8mm | KT126112 - 12mm |
| KT126109 - 9mm | KT126113 - 13mm |

KT121100 8-Piece Fractional 6-Point Socket Set 1/4" Drive - Short

- 6-point sockets
- Chrome vanadium steel
- Heat-treated
- Packaged on socket rail



Set includes (also available individually):

- | | |
|------------------|------------------|
| KT121106 - 3/16" | KT121110 - 5/16" |
| KT121107 - 7/32" | KT121112 - 3/8" |
| KT121108 - 1/4" | KT121114 - 7/16" |
| KT121109 - 9/32" | KT121116 - 1/2" |

3/8" Drive Chrome | Complete Sets 3/8"

KT120045 45-Piece Fractional and Metric Spline Socket Set 3/8" Drive

- The universal spline socket design works on various fasteners such as spline, 6-point, 12-point, female torx and square
- It will even work on 50% rounded fasteners! It's like having six sockets in one!
- Features high-polish chrome-vanadium finish, which provides for long life and maximum corrosion resistance
- Packaged in a blow-molded case

Set Includes: standard and deep fractional (5/16" to 7/8") and metric (7mm to 19mm) sockets, 3/8" drive ratchet and 3- and 6-inch wobble extensions

Set includes (also available individually):

- | | | | | |
|-------------------|------------------------|----------------------|----------------------|-------------------------|
| KT120210 - 5/16" | KT120228 - 7/8" | KT120428 - 7/8" deep | KT120318 - 18mm | KT120714 - 14mm deep |
| KT120212 - 3/8" | KT120412 - 3/8" deep | KT120310 - 10mm | KT120319 - 19mm | KT120715 - 15mm deep |
| KT120214 - 7/16" | KT120414 - 7/16" deep | KT120311 - 11mm | KT120707 - 7mm deep | KT120716 - 16mm deep |
| KT120216 - 1/2" | KT120416 - 1/2" deep | KT120312 - 12mm | KT120708 - 8mm deep | KT120717 - 17mm deep |
| KT120218 - 9/16" | KT120418 - 9/16" deep | KT120313 - 13mm | KT120709 - 9mm deep | KT120718 - 18mm deep |
| KT120220 - 5/8" | KT120420 - 5/8" deep | KT120314 - 14mm | KT120710 - 10mm deep | KT120719 - 19mm deep |
| KT120222 - 11/16" | KT120422 - 11/16" deep | KT120315 - 15mm | KT120711 - 11mm deep | KT122092 - Ratchet |
| KT120224 - 3/4" | KT120424 - 3/4" deep | KT120316 - 16mm | KT120712 - 12mm deep | KT122003 - 3" Extension |
| KT120226 - 13/16" | KT120426 - 13/16" deep | KT120317 - 17mm | KT120713 - 13mm deep | KT122006 - 6" Extension |



3/8" Drive Chrome | Complete Sets 3/8"

KTI22047

47-Piece Fractional and Metric 6-point Socket Set 3/8" Drive

- Manufactured with heat-treated chrome vanadium steel
- Packaged in custom blow-molded carrying case

Includes: short fractional sockets from 1/4"-7/8"; deep fractional sockets from 3/8"-7/8"; short metric sockets from 6mm - 19mm; deep metric sockets from 10mm - 19mm; 3/8 drive pro ratchet; 3" extension; 6" extension.

Set includes (also available individually):

KTI22108 - 1/4"
KTI22110 - 5/16"
KTI22112 - 3/8"
KTI22114 - 7/16"
KTI22116 - 1/2"
KTI22118 - 9/16"
KTI22120 - 5/8"
KTI22122 - 11/16"
KTI22124 - 3/4"
KTI22126 - 13/16"

KTI22128 - 7/8"
KTI22212 - 3/8" deep
KTI22214 - 7/16" deep
KTI22216 - 1/2" deep
KTI22218 - 9/16" deep
KTI22220 - 5/8" deep
KTI22222 - 11/16" deep
KTI22224 - 3/4" deep
KTI22226 - 13/16" deep
KTI22228 - 7/8" deep

KTI27106 - 6mm
KTI27107 - 7mm
KTI27108 - 8mm
KTI27109 - 9mm
KTI27110 - 10mm
KTI27111 - 11mm
KTI27112 - 12mm
KTI27113 - 13mm
KTI27114 - 14mm
KTI27115 - 15mm

KTI27116 - 16mm
KTI27117 - 17mm
KTI27118 - 18mm
KTI27119 - 19mm
KTI27210 - 10mm deep
KTI27211 - 11mm deep
KTI27212 - 12mm deep
KTI27213 - 13mm deep
KTI27214 - 14mm deep
KTI27215 - 15mm deep

KTI27216 - 16mm deep
KTI27217 - 17mm deep
KTI27218 - 18mm deep
KTI27219 - 19mm deep
KTI22092 - Ratchet
KTI22003 - 3" Extension
KTI22006 - 6" Extension



6 PT

LIFETIME WARRANTY*

KTI22547

47-Piece Fractional and Metric 12-point Socket Set 3/8" Drive

- Manufactured with heat-treated chrome vanadium steel
- Packaged in custom blow-molded carrying case

Includes: short fractional sockets from 1/4" - 7/8"; deep fractional sockets from 3/8"-7/8"; short metric sockets from 6mm - 19mm; deep metric sockets from 10mm - 19mm; 3/8 drive pro ratchet; 3" extension; 6" extension.

Set includes (also available individually):

KTI22508 - 1/4"
KTI22510 - 5/16"
KTI22512 - 3/8"
KTI22514 - 7/16"
KTI22516 - 1/2"
KTI22518 - 9/16"
KTI22520 - 5/8"
KTI22522 - 11/16"
KTI22524 - 3/4"
KTI22526 - 13/16"

KTI22528 - 7/8"
KTI22412 - 3/8" deep
KTI22414 - 7/16" deep
KTI22416 - 1/2" deep
KTI22418 - 9/16" deep
KTI22420 - 5/8" deep
KTI22422 - 11/16" deep
KTI22424 - 3/4" deep
KTI22426 - 13/16" deep
KTI22428 - 7/8" deep

KTI27506 - 6mm
KTI27507 - 7mm
KTI27508 - 8mm
KTI27509 - 9mm
KTI27510 - 10mm
KTI27511 - 11mm
KTI27512 - 12mm
KTI27513 - 13mm
KTI27514 - 14mm
KTI27515 - 15mm

KTI27516 - 16mm
KTI27517 - 17mm
KTI27518 - 18mm
KTI27519 - 19mm
KTI27410 - 10mm deep
KTI27411 - 11mm deep
KTI27412 - 12mm deep
KTI27413 - 13mm deep
KTI27414 - 14mm deep
KTI27415 - 15mm deep

KTI27416 - 16mm deep
KTI27417 - 17mm deep
KTI27418 - 18mm deep
KTI27419 - 19mm deep
KTI22092 - Ratchet
KTI22003 - 3" Extension
KTI22006 - 6" Extension



LIFETIME WARRANTY*

12 PT

KTI27000

26-Piece Metric 6-Point Socket Set 3/8" Drive

- All sockets are 6-point chrome vanadium steel
- Packaged in a blow-molded case

Includes 14 short sockets from 8mm to 21mm, 9 deep sockets from 10mm to 19mm, push button ratchet, spark plug socket and extension.

Set includes (also available individually):

KTI27108 - 8mm
KTI27109 - 9mm
KTI27110 - 10mm
KTI27111 - 11mm
KTI27112 - 12mm
KTI27113 - 13mm
KTI27114 - 14mm
KTI27115 - 15mm
KTI27116 - 16mm

KTI27117 - 17mm
KTI27118 - 18mm
KTI27119 - 19mm
KTI27120 - 20mm
KTI27121 - 21mm
KTI27210 - 10mm deep
KTI27211 - 11mm deep
KTI27212 - 12mm deep
KTI27213 - 13mm deep

KTI27214 - 14mm deep
KTI27216 - 16mm deep
KTI27217 - 17mm deep
KTI27218 - 18mm deep
KTI27219 - 19mm deep
KTI22219 - 5/8" Spark Plug
KTI22091 - Ratchet
KTI22003 - 3" Extension



6 PT

LIFETIME WARRANTY*

KTI22000

20-Piece Fractional 6-Point Socket Set 3/8" Drive

- All sockets are 6-point chrome vanadium steel
- Packaged in a blow-molded case

Includes 9 short sockets from 3/8" to 7/8", 8 deep sockets from 3/8" to 13/16", push button ratchet plus 2" and 3" extensions.

Set includes (also available individually):

KTI22112 - 3/8"
KTI22114 - 7/16"
KTI22116 - 1/2"
KTI22118 - 9/16"
KTI22120 - 5/8"
KTI22122 - 11/16"
KTI22124 - 3/4"

KTI22126 - 13/16"
KTI22128 - 7/8"
KTI22212 - 3/8" deep
KTI22214 - 7/16" deep
KTI22216 - 1/2" deep
KTI22218 - 9/16" deep
KTI22220 - 5/8" deep

KTI22222 - 11/16" deep
KTI22224 - 3/4" deep
KTI22226 - 13/16" deep
KTI22091 - Ratchet
KTI22002 - 2" Extension
KTI22003 - 3" Extension



6 PT

LIFETIME WARRANTY*



HAND TOOLS

3/8" Drive Chrome | Complete Sets 3/8"



12 PT LIFETIME WARRANTY*

KT122023 23 Piece 3/8" Drive Chrome Socket Set

- All sockets are 12-point
- Features high polish chrome vanadium finish, which provides for long life and maximum corrosion resistance
- Packaged in a blow-molded plastic case

Includes: 3/8" drive pro-series ratchet, flex handle and speed handle, Short fractional sockets from 3/8" to 7/8"; deep fractional sockets from 1/2" to 13/16", universal joint, 1/2" and 9/16" universal sockets, 6" and 12" extensions

Set includes (also available individually):

- | | |
|-----------------------------------|-------------------------|
| KT122512 - 3/8" short | KT122514 - 7/16" short |
| KT122516 - 1/2" short | KT122518 - 9/16" short |
| KT122520 - 5/8" short | KT122522 - 11/16" short |
| KT122524 - 3/4" short | KT122526 - 13/16" short |
| KT122528 - 7/8" short | |
| KT122416 - 3/8" deep | KT122418 - 9/16" deep |
| KT122420 - 5/8" deep | KT122422 - 11/16" deep |
| KT122424 - 3/4" deep | KT122426 - 13/16" deep |
| KT122006 - 6" Extension | |
| KT122012 - 12" Extension | |
| KT122716 - 1/2" Universal Socket | |
| KT122718 - 9/16" Universal Socket | |
| KT122500 - Universal Joint | |
| KT122091 - Pro-Series Ratchet | |
| KT122071 - Speed Handle | |
| KT122080 - Flex Handle | |



KT122100 10-Piece Fractional 6-Point Socket Set 3/8" Drive - Short

LIFETIME WARRANTY* 6 PT

- Chrome vanadium steel
 - Heat-treated and packaged on a socket rail
- Includes 6-point sockets from 5/16" to 7/8"

Set includes (also available individually):

- | | |
|------------------|-------------------|
| KT122110 - 5/16" | KT122120 - 5/8" |
| KT122112 - 3/8" | KT122122 - 11/16" |
| KT122114 - 7/16" | KT122124 - 3/4" |
| KT122116 - 1/2" | KT122126 - 13/16" |
| KT122118 - 9/16" | KT122128 - 7/8" |

KT122501 13-Piece Fractional 12-Point Socket Set 3/8" Drive - Short



- Chrome vanadium steel
 - Heat-treated and packaged on a socket rail
- Includes 12-point sockets from 1/4" to 1"

LIFETIME WARRANTY* 12 PT

Set includes (also available individually):

- | | | |
|------------------|-------------------|-------------------|
| KT122508 - 1/4" | KT122518 - 9/16" | KT122528 - 7/8" |
| KT122510 - 5/16" | KT122520 - 5/8" | KT122530 - 15/16" |
| KT122512 - 3/8" | KT122522 - 11/16" | KT122532 - 1" |
| KT122514 - 7/16" | KT122524 - 3/4" | |
| KT122516 - 1/2" | KT122526 - 13/16" | |

KT127501 15-Piece Metric 12-Point Socket Set 3/8" Drive - Short



- Chrome vanadium steel, heat-treated, packaged on a socket rail
- Includes: 12-point sockets from 7mm to 21mm

LIFETIME WARRANTY* 12 PT

Set includes (also available individually):

- | | | |
|-----------------|-----------------|-----------------|
| KT127507 - 7mm | KT127512 - 12mm | KT127517 - 17mm |
| KT127508 - 8mm | KT127513 - 13mm | KT127518 - 18mm |
| KT127509 - 9mm | KT127514 - 14mm | KT127519 - 19mm |
| KT127510 - 10mm | KT127515 - 15mm | KT127520 - 20mm |
| KT127511 - 11mm | KT127516 - 16mm | KT127521 - 21mm |

KT127101 13-Piece Metric 6-Point Socket Set 3/8" Drive - Short



- Chrome vanadium steel
 - Heat-treated and packaged on a socket rail
- Includes 6-point sockets from 7mm to 19mm

LIFETIME WARRANTY* 6 PT

Set includes (also available individually):

- | | | |
|-----------------|-----------------|-----------------|
| KT127107 - 7mm | KT127112 - 12mm | KT127117 - 17mm |
| KT127108 - 8mm | KT127113 - 13mm | KT127118 - 18mm |
| KT127109 - 9mm | KT127114 - 14mm | KT127119 - 19mm |
| KT127110 - 10mm | KT127115 - 15mm | |
| KT127111 - 11mm | KT127116 - 16mm | |



3/8" Drive Chrome | Complete Sets 3/8"

KTI22700

8-Piece Universal 12-Point Socket Set 3/8" Drive

- Use with an extension to turn bolts or nuts in difficult-to-access areas
 - Chrome vanadium steel, heat-treated
 - All universal joints are 3/8" drive, 12-point sockets.
- Includes: 5/16" to 3/4" universal joints

Set includes (also available individually):

KTI22710 - 5/16"
KTI22712 - 3/8"

KTI22714 - 7/16"
KTI22716 - 1/2"

KTI22718 - 9/16"
KTI22720 - 5/8"

KTI22722 - 11/16"
KTI22724 - 3/4"



LIFETIME WARRANTY*

12 PT



LIFETIME WARRANTY*

6 PT

KTI27201

9-Piece Metric

6-Point Socket Set 3/8" Drive - Deep

- Chrome vanadium steel, heat-treated, packaged on a socket rail
- Includes: 6-point sockets from 10mm to 18mm

Set includes (also available individually):

KTI27210 - 10mm
KTI27211 - 11mm
KTI27212 - 12mm
KTI27213 - 13mm
KTI27214 - 14mm

KTI27215 - 15mm
KTI27216 - 16mm
KTI27217 - 17mm
KTI27218 - 18mm



KTI22401

13-Piece Fractional

12-Point Socket Set 3/8" Drive - Deep

- Chrome vanadium steel, heat-treated, packaged on a socket rail
- Includes: 12-point sockets from 1/4" to 1"

Set includes (also available individually):

KTI22408 - 1/4" deep
KTI22410 - 5/16" deep
KTI22412 - 3/8" deep
KTI22414 - 7/16" deep
KTI22416 - 1/2" deep
KTI22418 - 9/16" deep

KTI22420 - 5/8" deep
KTI22422 - 11/16" deep
KTI22424 - 3/4" deep
KTI22426 - 13/16" deep
KTI22428 - 7/8" deep
KTI22430 - 15/16"

KTI22432 - 1" deep

LIFETIME WARRANTY*

12 PT



LIFETIME WARRANTY*

12 PT

KTI27401

15-Piece Metric 12-Point Socket Set 3/8" Drive - Deep

- Chrome vanadium steel, heat-treated, packaged on a socket rail
- Includes: 12-point sockets from 7mm to 21mm

Set includes (also available individually):

KTI27407 - 7mm deep
KTI27408 - 8mm deep
KTI27409 - 9mm deep
KTI27410 - 10mm deep
KTI27411 - 11mm deep
KTI27412 - 12mm deep
KTI27413 - 13mm deep

KTI27414 - 14mm deep
KTI27415 - 15mm deep
KTI27416 - 16mm deep
KTI27417 - 17mm deep
KTI27418 - 18mm deep
KTI27419 - 19mm deep
KTI27420 - 20mm deep
KTI27421 - 21mm deep



KTI22201

9-Piece Fractional

6-Point Socket Set 3/8" Drive - Deep

- Chrome vanadium steel
 - Heat-treated and packaged on a socket rail
- Includes 6-point sockets from 3/8" to 7/8"

Set includes (also available individually):

KTI22212 - 3/8" deep
KTI22214 - 7/16" deep
KTI22216 - 1/2" deep
KTI22218 - 9/16" deep
KTI22220 - 5/8" deep

KTI22222 - 11/16" deep
KTI22224 - 3/4" deep
KTI22226 - 13/16" deep
KTI22228 - 7/8" deep

LIFETIME WARRANTY*

6 PT

3/8" Drive Chrome | Specialty Sockets

Spark Plug Sockets:

6-point with rubber plug holder, hex top for wrench in tight areas.

KTI22221 - 5/8" KTI22227 - 13/16"



LIFETIME WARRANTY*

6 PT

Flex Spark Plug Sockets:

Flex joint 3/8" drive, chrome plated, chrome vanadium steel, heat-treated.

KTI22521 - 5/8"
KTI22527 - 13/16"



6 PT

LIFETIME WARRANTY*

KTI22133

3/8" Drive "2-in-1" Oil Sender Socket

- For oil sending units or stoplight switch replacement



LIFETIME WARRANTY*

KTI32229

3/8" Drive Oxygen Sensor Socket

- Used to remove and install oxygen sensors on most domestic and some imported vehicles



LIFETIME WARRANTY*

HAND TOOLS

3/8" Drive Chrome | Open Stock 3/8"

3/8" Drive Chrome Sockets - Fractional						
Size	Standard			Deep		
	6 pt	12 pt	Spline	6 pt	12 pt	Spline
1/4"	KTI22108	KTI22508		KTI22208	KTI22408	
5/16"	KTI22110	KTI22510	KTI20210	KTI22210	KTI22410	
3/8"	KTI22112	KTI22512	KTI20212	KTI22212	KTI22412	KTI20412
7/16"	KTI22114	KTI22514	KTI20214	KTI22214	KTI22414	KTI20414
1/2"	KTI22116	KTI22516	KTI20216	KTI22216	KTI22416	KTI20416
9/16"	KTI22118	KTI22518	KTI20218	KTI22218	KTI22418	KTI20418
5/8"	KTI22120	KTI22520	KTI20220	KTI22220	KTI22420	KTI20420
11/16"	KTI22122	KTI22522	KTI20222	KTI22222	KTI22422	KTI20422
3/4"	KTI22124	KTI22524	KTI20224	KTI22224	KTI22424	KTI20424
13/16"	KTI22126	KTI22526	KTI20226	KTI22226	KTI22426	KTI20426
7/8"	KTI22128	KTI22528	KTI20228	KTI22228	KTI22428	KTI20428
15/16"	KTI22130	KTI22530		KTI22230	KTI22430	
1"	KTI22132	KTI22532		KTI22232	KTI22432	

3/8" Drive Chrome Sockets - Metric						
Size	Standard			Deep		
	6 pt	12 pt	Spline	6 pt	12 pt	Spline
6mm	KTI27106	KTI27506		KTI27206		
7mm	KTI27107	KTI27507		KTI27207	KTI27407	KTI20707
8mm	KTI27108	KTI27508		KTI27208	KTI27408	KTI20708
9mm	KTI27109	KTI27509		KTI27209	KTI27409	KTI20709
10mm	KTI27110	KTI27510	KTI20310	KTI27210	KTI27410	KTI20710
11mm	KTI27111	KTI27511	KTI20311	KTI27211	KTI27411	KTI20711
12mm	KTI27112	KTI27512	KTI20312	KTI27212	KTI27412	KTI20712
13mm	KTI27113	KTI27513	KTI20313	KTI27213	KTI27413	KTI20713
14mm	KTI27114	KTI27514	KTI20314	KTI27214	KTI27414	KTI20714
15mm	KTI27115	KTI27515	KTI20315	KTI27215	KTI27415	KTI20715
16mm	KTI27116	KTI27516	KTI20316	KTI27216	KTI27416	KTI20716
17mm	KTI27117	KTI27517	KTI20317	KTI27217	KTI27417	KTI20717
18mm	KTI27118	KTI27518	KTI20318	KTI27218	KTI27418	KTI20718
19mm	KTI27119	KTI27519	KTI20319	KTI27219	KTI27419	KTI20719
20mm	KTI27120	KTI27520		KTI27220	KTI27420	
21mm	KTI27121	KTI27521		KTI27221	KTI27421	
22mm	KTI27122			KTI27222		
23mm	KTI27123			KTI27223		
24mm	KTI27124			KTI27224		
25mm	KTI27125			KTI27225		
26mm	KTI27126			KTI27226		



3/8" Drive Impact | Complete Sets 3/8"

KTI37042 42-piece Fractional and Metric Impact Socket Set 3/8" Drive

- Manufactured from heat-treated chrome-moly steel for wear in professional, rugged environments.
- All sockets are 6-point, 3/8" drive.
- Laser engraved for quick identification
- Packaged in a convenient blow-molded case

Includes: 8 short fractional sockets sized from 5/16" to 3/4", 8 deep fractional sockets sized from 5/16" to 3/4", 12 short metric sockets sized from 8mm to 19mm, 12 deep metric sockets sized from 8mm to 19mm, universal joint and 3" extension.

Set includes (also available individually):

KTI32110 - 5/16"
KTI32112 - 3/8"
KTI32114 - 7/16"
KTI32116 - 1/2"
KTI32118 - 9/16"
KTI32120 - 5/8"
KTI32122 - 11/16"
KTI32124 - 3/4"
KTI32210 - 5/16" deep

KTI32212 - 3/8" deep
KTI32214 - 7/16" deep
KTI32216 - 1/2" deep
KTI32218 - 9/16" deep
KTI32220 - 5/8" deep
KTI32222 - 11/16" deep
KTI32224 - 3/4" deep
KTI37108 - 8mm
KTI37109 - 9mm

KTI37110 - 10mm
KTI37111 - 11mm
KTI37112 - 12mm
KTI37113 - 13mm
KTI37114 - 14mm
KTI37115 - 15mm
KTI37116 - 16mm
KTI37117 - 17mm
KTI37118 - 18mm

KTI37119 - 19mm
KTI37208 - 8mm deep
KTI37209 - 9mm deep
KTI37210 - 10mm deep
KTI37211 - 11mm deep
KTI37212 - 12mm deep
KTI37213 - 13mm deep
KTI37214 - 14mm deep
KTI37215 - 15mm deep

KTI37216 - 16mm deep
KTI37217 - 17mm deep
KTI37218 - 18mm deep
KTI37219 - 19mm deep
KTI32003 - 3" Extension
KTI32013 - Universal Joint



LIFETIME WARRANTY*

6 PT

KTI32100 9-Piece Fractional Impact Socket Set 3/8" Drive - Short

- Chrome moly steel, thin wall impact
- Heat-treated
- Packaged in a blow-molded case

Includes: 6-point sockets from 3/8" to 7/8"

Set includes (also available individually):

KTI32112 - 3/8" KTI32122 - 11/16"
KTI32114 - 7/16" KTI32124 - 3/4"
KTI32116 - 1/2" KTI32126 - 13/16"
KTI32118 - 9/16" KTI32128 - 7/8"
KTI32120 - 5/8"

LIFETIME WARRANTY*

6 PT



KTI37100 10-Piece Metric Impact Socket Set 3/8" Drive - Short

- Chrome moly steel, thin wall impact
- Heat-treated
- Packaged in a blow-molded case

Includes: 6-point sockets from 10mm to 19mm

Set includes (also available individually):

KTI37110 - 10mm KTI37115 - 15mm
KTI37111 - 11mm KTI37116 - 16mm
KTI37112 - 12mm KTI37117 - 17mm
KTI37113 - 13mm KTI37118 - 18mm
KTI37114 - 14mm KTI37119 - 19mm

LIFETIME WARRANTY*



KTI32200 9-Piece Fractional Impact Socket Set 3/8" Drive - Deep

- Chrome moly steel, thin wall impact
- Heat-treated
- Packaged in a blow-molded case

Includes: 6-point sockets from 3/8" to 7/8"

Set includes (also available individually):

KTI32212 - 3/8" deep KTI32222 - 11/16" deep
KTI32214 - 7/16" deep KTI32224 - 3/4" deep
KTI32216 - 1/2" deep KTI32226 - 13/16" deep
KTI32218 - 9/16" deep KTI32228 - 7/8" deep
KTI32220 - 5/8" deep

LIFETIME WARRANTY*

6 PT



KTI37200 10-Piece Metric Impact Socket Set 3/8" Drive - Deep

- Chrome moly steel, thin wall impact
- Heat-treated
- Packaged in a blow-molded case

Includes: 6-point sockets from 10mm to 19mm

Set includes (also available individually):

KTI37210 - 10mm deep KTI37215 - 15mm deep
KTI37211 - 11mm deep KTI37216 - 16mm deep
KTI37212 - 12mm deep KTI37217 - 17mm deep
KTI37213 - 13mm deep KTI37218 - 18mm deep
KTI37214 - 14mm deep KTI37219 - 19mm deep

LIFETIME WARRANTY*

6 PT



HAND TOOLS

3/8" Drive Impact | Complete Sets 3/8"

KTI32500 6-Piece Fractional Impact Flex Socket Set 3/8" Drive - Short



- Chrome moly steel, close quarter, thin wall, heat-treated
 - Packaged in a blow-molded case
- Includes: 6-point sockets from 7/16" to 3/4"



Set includes (also available individually):
KTI32514 - 7/16" **KTI32520** - 5/8"
KTI32516 - 1/2" **KTI32522** - 11/16"
KTI32518 - 9/16" **KTI32524** - 3/4"

KTI32400 6-Piece Fractional Impact Flex Socket Set 3/8" Drive - Deep



- Chrome moly steel, close quarter, thin wall, heat-treated
 - Packaged in a blow-molded case
- Includes: 6-point sockets from 7/16" to 3/4"



Set includes (also available individually):
KTI32414 - 7/16" deep **KTI32420** - 5/8" deep
KTI32416 - 1/2" deep **KTI32422** - 11/16" deep
KTI32418 - 9/16" deep **KTI32424** - 3/4" deep

KTI37500 6-Piece Metric Impact Flex Socket Set 3/8" Drive - Short



- Chrome moly steel, close quarter, thin wall, heat-treated
 - Packaged in a blow-molded case
- Includes: 6-point sockets from 10mm to 15mm



Set includes (also available individually):
KTI37510 - 10mm **KTI37513** - 13mm
KTI37511 - 11mm **KTI37514** - 14mm
KTI37512 - 12mm **KTI37515** - 15mm



KTI37400 10-Piece Metric Impact Flex Socket Set 3/8" Drive - Deep



- Chrome moly steel, close quarter, thin wall, heat-treated
 - Packaged in a blow-molded case
- Includes: 6-point sockets from 10mm to 19mm

Set includes (also available individually):
KTI37410 - 10mm deep **KTI37415** - 15mm deep
KTI37411 - 11mm deep **KTI37416** - 16mm deep
KTI37412 - 12mm deep **KTI37417** - 17mm deep
KTI37413 - 13mm deep **KTI37418** - 18mm deep
KTI37414 - 14mm deep **KTI37419** - 19mm deep

3/8" Drive Impact Sockets - Fractional

Size	Standard		Deep	
	6 pt	6 pt Flex	6 pt	6 pt Flex
1/4"				
5/16"	KTI32110		KTI32210	
3/8"	KTI32112		KTI32212	
7/16"	KTI32114	KTI32514	KTI32214	KTI32414
1/2"	KTI32116	KTI32516	KTI32216	KTI32416
9/16"	KTI32118	KTI32518	KTI32218	KTI32418
5/8"	KTI32120	KTI32520	KTI32220	KTI31420
11/16"	KTI32122	KTI32522	KTI32222	KTI32422
3/4"	KTI32124	KTI32524	KTI32224	KTI32424
13/16"	KTI32126		KTI32226	
7/8"	KTI32128		KTI32228	

3/8" Drive Impact Sockets - Metric

Size	Standard		Deep	
	6 pt	6 pt Flex	6 pt	Flex
8mm	KTI37108		KTI37208	
9mm	KTI37109		KTI37209	
10mm	KTI37110	KTI37510	KTI37210	KTI37410
11mm	KTI37111	KTI37511	KTI37211	KTI37411
12mm	KTI37112	KTI37512	KTI37212	KTI37412
13mm	KTI37113	KTI37513	KTI37213	KTI37413
14mm	KTI37114	KTI37514	KTI37214	KTI37414
15mm	KTI37115	KTI37515	KTI37215	KTI37415
16mm	KTI37116		KTI37216	KTI37416
17mm	KTI37117		KTI37217	KTI37417
18mm	KTI37118		KTI37218	KTI37418
19mm	KTI37119		KTI37219	KTI37419



1/2" Drive Chrome | Complete Sets 1/2"

6 PT **LIFETIME WARRANTY***

KTI23000 16-Piece Fractional 6-Point Socket Set 1/2" Drive - Short

• All sockets are 6-point chrome vanadium • Packaged in a blow-molded case
Includes: 13 sockets from 7/16" through 1 1/4", ratchet, breaker bar and extension.

Set includes (also available individually):

KTI23114 - 7/16"	KTI23126 - 13/16"	KTI23140 - 1-1/4"
KTI23116 - 1/2"	KTI23128 - 7/8"	KTI23091 - Ratchet
KTI23118 - 9/16"	KTI23130 - 15/16"	KTI23005 - 5" Extension
KTI23120 - 5/8"	KTI23132 - 1"	KTI23080 - 17" Breaker bar
KTI23122 - 11/16"	KTI23134 - 1-1/16"	
KTI23124 - 3/4"	KTI23136 - 1-1/8"	



6 PT **LIFETIME WARRANTY***

KTI28000 17-Piece Metric 6-Point Socket Set 1/2" Drive - Short

• All sockets are 6-point chrome vanadium
• Packaged in a blow-molded case
Includes: 14 sockets from 15mm to 28mm, push button ratchet, breaker bar and 5" extension

Set includes (also available individually):

KTI28115 - 15mm	KTI28121 - 21mm	KTI28127 - 27mm
KTI28116 - 16mm	KTI28122 - 22mm	KTI28128 - 28mm
KTI28117 - 17mm	KTI28123 - 23mm	KTI23091 - Ratchet
KTI28118 - 18mm	KTI28124 - 24mm	KTI23005 - 5" Extension
KTI28119 - 19mm	KTI28125 - 25mm	KTI23080 - 17" Breaker bar
KTI28120 - 20mm	KTI28126 - 26mm	



KTI23110 13-Piece Fractional 6-Point Socket Set, 1/2" Drive - Short

• Chrome vanadium steel, heat-treated
Includes: 6-point sockets from 7/16" to 1 1/4"

Set includes (also available individually):

KTI23114 - 7/16"	KTI23124 - 3/4"	KTI23134 - 1-1/16"
KTI23116 - 1/2"	KTI23126 - 13/16"	KTI23136 - 1-1/8"
KTI23118 - 9/16"	KTI23128 - 7/8"	KTI23140 - 1-1/4"
KTI23120 - 5/8"	KTI23130 - 15/16"	
KTI23122 - 11/16"	KTI23132 - 1"	



6 PT **LIFETIME WARRANTY***

KTI28100 14-Piece Metric 6-Point Socket Set 1/2" Drive - Short

• Chrome vanadium steel, heat-treated, packaged on a socket rail.
Includes: 6-point sockets from 15mm to 28mm

Set includes (also available individually):

KTI28115 - 15mm	KTI28120 - 20mm	KTI28125 - 25mm
KTI28116 - 16mm	KTI28121 - 21mm	KTI28126 - 26mm
KTI28117 - 17mm	KTI28122 - 22mm	KTI28127 - 27mm
KTI28118 - 18mm	KTI28123 - 23mm	KTI28128 - 28mm
KTI28119 - 19mm	KTI28124 - 24mm	



KTI23200 8-Piece Fractional 6-Point Socket Set 1/2" Drive - Deep

• Chrome vanadium steel, heat-treated
Includes: 6-point sockets from 1/2" to 15/16"

Set includes (also available individually):

KTI23216 - 1/2" deep	KTI23224 - 3/4" deep
KTI23218 - 9/16" deep	KTI23226 - 13/16" deep
KTI23220 - 5/8" deep	KTI23228 - 7/8" deep
KTI23222 - 11/16" deep	KTI23230 - 15/16" deep



6 PT **LIFETIME WARRANTY***

KTI28200 10-Piece Metric 6-Point Socket Set 1/2" Drive - Deep

• Chrome vanadium steel, heat-treated, packaged on a socket rail
Includes: 6-point sockets from 15mm to 24mm

Set includes (also available individually):

KTI28215 - 15mm deep	KTI28220 - 20mm deep
KTI28216 - 16mm deep	KTI28221 - 21mm deep
KTI28217 - 17mm deep	KTI28222 - 22mm deep
KTI28218 - 18mm deep	KTI28223 - 23mm deep
KTI28219 - 19mm deep	KTI28224 - 24mm deep



6 PT **LIFETIME WARRANTY***

KTI23800 4-Piece Fractional Stud Remover Set, 1/2" Drive

• Chrome vanadium steel, heat-treated
• Packaged in a blow-molded case

Set includes (also available individually):

KTI23808 - 1/4"
KTI23810 - 5/16"
KTI23812 - 3/8"
KTI23814 - 7/16"



LIFETIME WARRANTY*

KTI23900 4-Piece Metric Stud Remover Set 1/2" Drive

• Chrome vanadium steel, heat-treated
• Packaged in a blow-molded case

Set includes (also available individually):

KTI23906 - 6mm
KTI23908 - 8mm
KTI23910 - 10mm
KTI23912 - 12mm



LIFETIME WARRANTY*



HAND TOOLS

1/2" Drive Chrome | Open Stock 1/2"

1/2" Drive Chrome Sockets - Fractional			
Size	Standard		Deep
	6 pt	12 pt	6 pt
3/8"	KTI23112	KTI23512	
7/16"	KTI23114		KTI23214
1/2"	KTI23116	KTI23516	KTI23216
9/16"	KTI23118		KTI23218
5/8"	KTI23120		KTI23220
11/16"	KTI23122		KTI23222
3/4"	KTI23124		KTI23224
13/16"	KTI23126		KTI23226
7/8"	KTI23128		KTI23228
15/16"	KTI23130		KTI23230
1"	KTI23132		KTI23232
1-1/16"	KTI23134		KTI23234
1-1/8"	KTI23136		KTI23236
1-1/4"	KTI23140		KTI23240
1-5/16"	KTI23142		KTI23242
1-3/8"	KTI23144		KTI23244
1-7/16"	KTI23146		KTI23246
1-1/2"	KTI23148		KTI23348

1/2" Drive Chrome Sockets - Metric		
Size	Standard	Deep
	6 pt	6 pt
10mm	KTI28110	KTI28210
11mm	KTI28111	KTI28211
12mm	KTI28112	KTI28212
13mm	KTI28113	KTI28213
14mm	KTI28114	KTI28214
15mm	KTI28115	KTI28215
16mm	KTI28116	KTI28216
17mm	KTI28117	KTI28217
18mm	KTI28118	KTI28218
19mm	KTI28119	KTI28219
20mm	KTI28120	KTI28220
21mm	KTI28121	KTI28221
22mm	KTI28122	KTI28222
23mm	KTI28123	KTI28223
24mm	KTI28124	KTI28224
25mm	KTI28125	KTI28225
26mm	KTI28126	KTI28226
27mm	KTI28127	KTI28227
28mm	KTI28128	KTI28228

1/2" Drive Impact | Complete Sets 1/2"

KTI33100

12-Piece Fractional Impact Socket Set 1/2" Drive - Short

- Chrome moly steel, thin wall impact, heat-treated
 - Packaged in a blow-molded case
- Includes: 6-point sockets from 1/2" to 1-1/4"



Set includes (also available individually):

- | | | |
|-------------------|-------------------|--------------------|
| KTI33116 - 1/2" | KTI33124 - 3/4" | KTI33132 - 1" |
| KTI33118 - 9/16" | KTI33126 - 13/16" | KTI33134 - 1-1/16" |
| KTI33120 - 5/8" | KTI33128 - 7/8" | KTI33136 - 1-1/8" |
| KTI33122 - 11/16" | KTI33130 - 15/16" | KTI33140 - 1-1/4" |

KTI33104

Socket Impact Add-On Set 1/2" Drive

- 6-point 1/2" drive
 - Laser engraved for quick identification
 - Carded on socket rail.
- Includes: shallow sockets 1-5/16", 1-3/8", 1-7/16" and 1-1/2"



Set includes (also available individually):

- | | |
|--------------------|-------------------|
| KTI33142 - 1-5/16" | KTI33144 - 1-3/8" |
| KTI33146 - 1-7/16" | KTI33148 - 1-1/2" |



KTI33101

19-Piece Fractional Impact Socket Set 1/2" Drive - Short

- Chrome moly steel, thin wall impact, heat-treated
- Includes: 6-point sockets from 3/8" to 1-1/2"



Set includes (also available individually):

- | | | |
|-------------------|--------------------|--------------------|
| KTI33112 - 3/8" | KTI33126 - 13/16" | KTI33140 - 1-1/4" |
| KTI33114 - 7/16" | KTI33128 - 7/8" | KTI33142 - 1-5/16" |
| KTI33116 - 1/2" | KTI33130 - 15/16" | KTI33144 - 1-3/8" |
| KTI33118 - 9/16" | KTI33132 - 1" | KTI33146 - 1-7/16" |
| KTI33120 - 5/8" | KTI33134 - 1-1/16" | KTI33148 - 1-1/2" |
| KTI33122 - 11/16" | KTI33136 - 1-1/8" | |
| KTI33124 - 3/4" | KTI33138 - 1-3/16" | |



1/2" Drive Impact | Complete Sets 1/2"

KTI33200 12-Piece Fractional Impact Socket Set 1/2" Drive - Deep

- Chrome moly steel, thin wall impact, heat-treated
- Packaged in a blow-molded case

Includes: 6-point sockets from 1/2" to 1 1/4"



Set includes (also available individually):

KTI33216 - 1/2"	KTI33224 - 3/4"	KTI33232 - 1"
KTI33218 - 9/16"	KTI33226 - 13/16"	KTI33234 - 1-1/16"
KTI33220 - 5/8"	KTI33228 - 7/8"	KTI33236 - 1-1/8"
KTI33222 - 11/16"	KTI33230 - 15/16"	KTI33240 - 1-1/4"

KTI33204 4 Piece 6 Point Fractional Deep Impact Socket Set

Includes: 1-5/16", 1-3/8", 1-7/16" and 1-1/2"



Set includes (also available individually):

KTI33242 - 1-5/16" - deep	KTI33244 - 1-3/8" - deep
KTI33246 - 1-7/16" - deep	KTI33248 - 1-1/2" - deep

KTI33202 19-Piece Fractional Impact Socket Set 1/2" Drive - Deep

- Chrome moly steel, thin wall impact, heat-treated
- Includes: 6-point sockets from 3/8" to 1-1/2"



Set includes (also available individually):

KTI33212 - 3/8"	KTI33226 - 13/16"	KTI33240 - 1-1/4"
KTI33214 - 7/16"	KTI33228 - 7/8"	KTI33242 - 1-5/16"
KTI33216 - 1/2"	KTI33230 - 15/16"	KTI33244 - 1-3/8"
KTI33218 - 9/16"	KTI33232 - 1"	KTI33246 - 1-7/16"
KTI33220 - 5/8"	KTI33234 - 1-1/16"	KTI33248 - 1-1/2"
KTI33222 - 11/16"	KTI33236 - 1-1/8"	
KTI33224 - 3/4"	KTI33238 - 1-3/16"	

KTI38100 12-Piece Metric Impact Socket Set 1/2" Drive - Short

- Chrome moly steel, thin wall impact, heat-treated
 - Packaged in a blow-molded case
- Includes: 6-point sockets from 10mm to 21mm



Set includes (also available individually):

KTI38110 - 10mm	KTI38114 - 14mm	KTI38118 - 18mm
KTI38111 - 11mm	KTI38115 - 15mm	KTI38119 - 19mm
KTI38112 - 12mm	KTI38116 - 16mm	KTI38120 - 20mm
KTI38113 - 13mm	KTI38117 - 17mm	KTI38121 - 21mm

KTI38200 12-Piece Metric Impact Socket Set 1/2" Drive - Deep

- Chrome moly steel, thin wall impact, heat-treated
 - Packaged in a blow-molded case.
- Includes: 6-point sockets from 10mm to 21mm



Set includes (also available individually):

KTI38210 - 10mm	KTI38214 - 14mm	KTI38218 - 18mm
KTI38211 - 11mm	KTI38215 - 15mm	KTI38219 - 19mm
KTI38212 - 12mm	KTI38216 - 16mm	KTI38220 - 20mm
KTI38213 - 13mm	KTI38217 - 17mm	KTI38221 - 21mm

KTI38201 9 Piece 1/2" Drive 6 Point Metric Impact Socket Set

Includes: sizes: 22mm to 30mm



Set includes (also available individually):

KTI38222 - 22mm	KTI38223 - 23mm	KTI38224 - 24mm
KTI38225 - 25mm	KTI38226 - 26mm	KTI38227 - 27mm
KTI38228 - 28mm	KTI38229 - 29mm	KTI38230 - 30mm

KTI38101 26-Piece Metric Impact Socket Set 1/2" Drive - Short

- Chrome moly steel, thin wall impact, heat-treated
- Includes: 6-point sockets from 10mm to 36mm



Set includes (also available individually):

KTI38110 - 10mm	KTI38119 - 19mm	KTI38128 - 28mm
KTI38111 - 11mm	KTI38120 - 20mm	KTI38129 - 29mm
KTI38112 - 12mm	KTI38121 - 21mm	KTI38130 - 30mm
KTI38113 - 13mm	KTI38122 - 22mm	KTI38132 - 32mm
KTI38114 - 14mm	KTI38123 - 23mm	KTI38133 - 33mm
KTI38115 - 15mm	KTI38124 - 24mm	KTI38134 - 34mm
KTI38116 - 16mm	KTI38125 - 25mm	KTI38135 - 35mm
KTI38117 - 17mm	KTI38126 - 26mm	KTI38136 - 36mm
KTI38118 - 18mm	KTI38127 - 27mm	

KTI38202 26-Piece Metric Impact Socket Set 1/2" Drive - Deep

- Chrome moly steel, thin wall impact, heat-treated.
- Includes: 6-point sockets from 10mm to 36mm



Set includes (also available individually):

KTI38210 - 10mm	KTI38219 - 19mm	KTI38228 - 28mm
KTI38211 - 11mm	KTI38220 - 20mm	KTI38229 - 29mm
KTI38212 - 12mm	KTI38221 - 21mm	KTI38230 - 30mm
KTI38213 - 13mm	KTI38222 - 22mm	KTI38232 - 32mm
KTI38214 - 14mm	KTI38223 - 23mm	KTI38233 - 33mm
KTI38215 - 15mm	KTI38224 - 24mm	KTI38234 - 34mm
KTI38216 - 16mm	KTI38225 - 25mm	KTI38235 - 35mm
KTI38217 - 17mm	KTI38226 - 26mm	KTI38236 - 36mm
KTI38218 - 18mm	KTI38227 - 27mm	

HAND TOOLS

1/2" Drive Impact | Complete Sets 1/2"

KTI33500 7-Piece Fractional Impact Flex Socket Set 1/2" Drive

- Chrome moly steel, thin wall, heat-treated
 - Packaged in a blow-molded case
- Includes: 6-point sockets from 1/2" to 7/8"



Set includes (also available individually):
KTI33516 - 1/2" **KTI33524** - 3/4"
KTI33518 - 9/16" **KTI33526** - 13/16"
KTI33520 - 5/8" **KTI33528** - 7/8"
KTI33522 - 11/16"

KTI38500 6-Piece Metric Impact Flex Socket Set 1/2" Drive

- Chrome moly steel, thin wall, heat-treated
 - Packaged in a blow-molded case
- Includes: 6 point sockets from 13mm to 19mm



Set includes (also available individually):
KTI38513 - 13mm **KTI38517** - 17mm
KTI38514 - 14mm **KTI38518** - 18mm
KTI38515 - 15mm **KTI38519** - 19mm

1/2" Drive Impact | 1/2" Open Stock

1/2" Drive Impact Sockets - Fractional

Size	Standard		Deep
	6 pt	6 pt Flex	6 pt
3/8"	KTI33112		KTI33212
7/16"	KTI33114		KTI33214
1/2"	KTI33116	KTI33516	KTI33216
9/16"	KTI33118	KTI33518	KTI33218
5/8"	KTI33120	KTI33520	KTI33220
11/16"	KTI33122	KTI33522	KTI33222
3/4"	KTI33124	KTI33524	KTI33224
13/16"	KTI33126	KTI33526	KTI33226
7/8"	KTI33128	KTI33528	KTI33228
15/16"	KTI33130		KTI33230
1"	KTI33132		KTI33232
1-1/16"	KTI33134		KTI33234
1-1/8"	KTI33136		KTI33236
1-3/16"	KTI33138		KTI33238
1-1/4"	KTI33140		KTI33240
1-5/16"	KTI33142		KTI33242
1-3/8"	KTI33144		KTI33244
1-7/16"	KTI33146		KTI33246
1-1/2"	KTI33148		KTI33248

1/2" Drive Flip Impact Socket

KTI33050 - 3/4" x 13/16"
KTI38050 - 19mm-21mm



1/2" Drive Impact Sockets - Metric

Size	Standard		Deep
	6 pt	6 pt Flex	6 pt
10mm	KTI38110		KTI38210
11mm	KTI38111		KTI38211
12mm	KTI38112		KTI38212
13mm	KTI38113	KTI38513	KTI38213
14mm	KTI38114	KTI38514	KTI38214
15mm	KTI38115	KTI38515	KTI38215
16mm	KTI38116		KTI38216
17mm	KTI38117	KTI38517	KTI38217
18mm	KTI38118	KTI38518	KTI38218
19mm	KTI38119	KTI38519	KTI38219
20mm	KTI38120		KTI38220
21mm	KTI38121		KTI38221
22mm	KTI38122		KTI38222
23mm	KTI38123		KTI38223
24mm	KTI38124		KTI38224
25mm	KTI38125		KTI38225
26mm	KTI38126		KTI38226
27mm	KTI38127		KTI38227
28mm	KTI38128		KTI38228
29mm	KTI38129		KTI38229
30mm	KTI38130		KTI38230
31mm			
32mm	KTI38132		KTI38232
33mm	KTI38133		KTI38233
34mm	KTI38134		KTI38234
35mm	KTI38135		KTI38235
36mm	KTI38136		KTI38236



3/4" Drive Chrome | Complete Sets 3/4"



6 PT **LIFETIME WARRANTY***

KTI24121 20-Piece Fractional 6-Point Socket Set 3/4" Drive

- 6-point high polished chrome vanadium steel
- Packaged in blow-molded case

Includes: 16 sockets from 3/4" to 2", ratchet, T-handle and 4" and 8" extensions

Set includes (also available individually):

KTI24124 - 3/4"	KTI24140 - 1-1/4"	KTI24160 - 1-7/8"
KTI24128 - 7/8"	KTI24142 - 1-5/16"	KTI24164 - 2"
KTI24130 - 15/16"	KTI24144 - 1-3/8"	KTI24090 - Ratchet
KTI24132 - 1"	KTI24146 - 1-7/16"	KTI24004 - 4" Extension
KTI24134 - 1-1/16"	KTI24148 - 1-1/2"	KTI24008 - 8" Extension
KTI24136 - 1-1/8"	KTI24152 - 1-5/8"	KTI24070 - T-handle
KTI24138 - 1-13/16"	KTI24156 - 1-3/4"	



KTI24105 5-Piece Fractional 6-Point Socket Set 3/4" Drive

- Socket assortment is a perfect addition to the KTI24121 3/4" drive socket set
- Chrome vanadium

Includes: 5 sockets from 2-1/16" to 2-3/8"

Set includes (also available individually):

KTI24166 - 2-1/16"
KTI24168 - 2-1/8"
KTI24170 - 2-3/16"
KTI24172 - 2-1/4"
KTI24176 - 2-3/8"

6 PT **LIFETIME WARRANTY***

3/4" Drive Chrome | 3/4" Open Stock

3/4" Drive Chrome Sockets		
Standard		
Size	6 pt	12 pt
3/4"	KTI24124	
7/8"	KTI24128	
15/16"	KTI24130	
1"	KTI24132	
1-1/16"	KTI24134	
1-1/8"	KTI24136	
1-3/16"	KTI24138	
1-1/4"	KTI24140	
1-5/16"	KTI24142	
1-3/8"	KTI24144	
1-7/16"	KTI24146	
1-1/2"	KTI24148	
1-5/8"	KTI24152	
1-3/4"	KTI24156	
1-7/8"	KTI24160	
2"	KTI24164	
2-1/16"	KTI24166	
2-1/8"	KTI24168	
2-3/16"	KTI24170	
2-1/4"	KTI24172	KTI24173
2-3/8"	KTI24176	



HAND TOOLS

3/4" Drive Impact | Complete Sets 3/4"

KTI34100 8-Piece Fractional Impact Socket Set 3/4" Drive - Short



- Chrome moly steel, heat-treated
 - Packaged in a blow-molded case
- Includes: 6 point sockets from 1" to 1-1/2"



Set includes (also available individually):

KTI34132 - 1"	KTI34142 - 1-5/16"
KTI34134 - 1-1/16"	KTI34144 - 1-3/8"
KTI34136 - 1-1/8"	KTI34146 - 1-7/16"
KTI34140 - 1-1/4"	KTI34148 - 1-1/2"

KTI34200 8-Piece Fractional Impact Socket Set 3/4" Drive - Deep



- Chrome moly steel, heat-treated
 - Packaged in a blow-molded case
- Includes: 6-point sockets from 1" to 1-1/2"



Set includes (also available individually):

KTI34232 - 1"	KTI34242 - 1-5/16"
KTI34234 - 1-1/16"	KTI34244 - 1-3/8"
KTI34236 - 1-1/8"	KTI34246 - 1-7/16"
KTI34240 - 1-1/4"	KTI34248 - 1-1/2"

KTI34101 12-Piece Fractional Impact Socket Set 3/4" Drive - Short



- Chrome moly steel, heat-treated
- Includes: 6-point sockets from 1-9/16" to 2-3/8"



Set includes (also available individually):

KTI34150 - 1-9/16"	KTI34158 - 1-13/16"	KTI34166 - 2-1/16"
KTI34152 - 1-5/8"	KTI34160 - 1-15/16"	KTI34168 - 2-1/8"
KTI34154 - 1-11/16"	KTI34162 - 1-7/8"	KTI34172 - 2-1/4"
KTI34156 - 1-3/4"	KTI34164 - 2"	KTI34176 - 2-3/8"

KTI34201 8-Piece Fractional Impact Socket Set 3/4" Drive - Deep



- Chrome moly steel, heat-treated
- Includes: 6-point sockets from 1-9/16" to 2"



Set includes (also available individually):

KTI34250 - 1-9/16"	KTI34258 - 1-13/16"
KTI34252 - 1-5/8"	KTI34260 - 1-15/16"
KTI34254 - 1-11/16"	KTI34262 - 1-7/8"
KTI34256 - 1-3/4"	KTI34264 - 2"

KTI39100 15-Piece Metric Impact Socket Set 3/4" Drive - Short



- This set is capable of handling larger applications, such as removal of truck wheels and lug nuts
 - Manufactured from heat-treated chrome-moly steel
 - Packaged in a convenient blow-molded case
- Includes: metric sockets sized 17mm to 46mm and replacement o-rings and pins.

Set includes (also available individually):

KTI39117 - 17mm	KTI39130 - 30mm	KTI39138 - 38mm
KTI39119 - 19mm	KTI39131 - 31mm	KTI39140 - 40mm
KTI39120 - 20mm	KTI39132 - 32mm	KTI39146 - 46mm
KTI39122 - 22mm	KTI39134 - 34mm	KTI39001 - O-rings 1.42"/36mm
KTI39124 - 24mm	KTI39135 - 35mm	KTI39003 - Pins 1.375"/35mm
KTI39127 - 27mm	KTI39136 - 36mm	



3/4" Drive Impact | 3/4" Open Stock

3/4" Drive Impact Sockets - Fractional & Metric				
	Standard	Deep		Standard
Size	6 pt	6 pt	Size	6 pt
1"	KTI34132	KTI34232	17mm	KTI39117
1-1/16"	KTI34134	KTI34234	19mm	KTI39119
1-1/8"	KTI34136	KTI34236	20mm	KTI39120
1-1/4"	KTI34140	KTI34240	22mm	KTI39122
1-5/16"	KTI34142	KTI34242	24mm	KTI39124
1-3/8"	KTI34144	KTI34244	27mm	KTI39127
1-7/16"	KTI34146	KTI34246	30mm	KTI39130
1-1/2"	KTI34148	KTI34248	31mm	KTI39131
1-9/16"	KTI34150	KTI34250	32mm	KTI39132
1-5/8"	KTI34152	KTI34252	34mm	KTI39134
1-11/16"	KTI34154	KTI34254	35mm	KTI39135
1-3/4"	KTI34156	KTI34256	36mm	KTI39136
1-13/16"	KTI34158	KTI34258	38mm	KTI39138
1-7/8"	KTI34162	KTI34262	40mm	KTI39140
1-15/16"	KTI34160	KTI34260	46mm	KTI39146
2"	KTI34164	KTI34264		
2-1/16"	KTI34166			
2-1/8"	KTI34168			
2-1/4"	KTI34172			
2-3/8"	KTI34176			

1" Drive Impact | 1" Open Stock

1" Drive Impact Sockets		
	Standard	Deep
Size	6 pt	6 pt
3/4"	KTI35124	
13/16"	KTI35126	
7/8"	KTI35128	
15/16"	KTI35130	
1"	KTI35132	
1-1/16"	KTI35134	KTI35234
1-1/8"	KTI35136	KTI35236
1-3/16"	KTI35138	
1-1/4"	KTI35140	KTI35240
1-5/16"	KTI35142	KTI35242
1-7/16"	KTI35146	
1-1/2"	KTI35148	
1-5/8"	KTI35152	
1-11/16"	KTI35154	
1-13/16"	KTI35158	
1-7/8"	KTI35160	
2"	KTI35164	
2-1/16"	KTI35166	
2-1/4"	KTI35172	
2-7/16"	KTI35178	
2-5/8"	KTI35184	
3"	KTI35196	

1" Drive Impact | Complete Sets 1"

KTI35100 18-Piece Fractional Impact Socket Set 1" Drive - Short

**LIFETIME
WARRANTY***

- Manufactured from heat-treated chrome-moly steel
- Packaged in a convenient blow-molded case

Includes: fractional sockets sized 3/4" to 2" and replacement o-rings and pins.

Set includes (also available individually):

- | | | |
|--------------------|---------------------|-------------------------------|
| KTI35124 - 3/4" | KTI35142 - 1-5/16" | KTI35007 - 7" Extension |
| KTI35126 - 13/16" | KTI35146 - 1-7/16" | KTI35013 - 13" Extension |
| KTI35128 - 7/8" | KTI35148 - 1-1/2" | KTI35001 - O-rings 1.75"/45mm |
| KTI35130 - 15/16" | KTI35152 - 1-5/8" | KTI35002 - O-rings 2"/51mm |
| KTI35132 - 1" | KTI35154 - 1-11/16" | KTI35003 - Pins 1.75"/45mm |
| KTI35134 - 1-1/16" | KTI35158 - 1-13/16" | KTI35004 - Pins 2"/51mm |
| KTI35136 - 1-1/8" | KTI35160 - 1-7/8" | |
| KTI35140 - 1-1/4" | KTI35164 - 2" | |



HAND TOOLS

1/4" Chrome | Accessories 1/4"

KT121091

1/4" Drive Push Button Ratchet

- High polish chrome finish, chrome vanadium steel, premium gears



LIFETIME WARRANTY*

KT121092

1/4" Drive 4-1/2" Professional Series Chrome Ratchet

- High polished chrome
- New design push button socket release
- Thumb lever directional switch
- Fine tooth thin design
- Knurled handles



LIFETIME WARRANTY*

R KT121092RK

KT121095

1/4" Drive 7" Long Handled Professional Series Chrome Ratchet

- High polished chrome
- New design push button socket release
- Thumb lever directional switch
- Fine tooth thin design • Knurled handles



LIFETIME WARRANTY*

KT121060

Spinner Handle 1/4" Drive

- Screwdriver style drive tool for quick spin down/off
- Oversize polypropylene handle and chrome vanadium shaft



LIFETIME WARRANTY*

KT122001

Speed T-Handle Set

- Aluminum sleeve for fast turning
- Locking end to hold socket securely in place
- Pivoting end to reach odd angles
- Includes adapter to use with any 1/4" hex bit



LIFETIME WARRANTY*

A 3/8" drive end allows the speed T-handle to be used with a ratchet like and extension. The speed T-handle set includes 1/4" and 3/8" speed T-handles and a posi-lock adapter that allows the use of any 1/4" hex bit.

KT121070

1/4" Drive Speed T-Handle

- Aluminum sleeve for fast turning
- Locking end to hold socket securely in place
- Pivoting end to reach odd angles
- 3/8" drive end for use with a ratchet - use like an extension



LIFETIME WARRANTY*

KT121061

1/4" Drive Spinner Handle

- 1/4" drive female square in handle
- Black Handle



LIFETIME WARRANTY*

KT121080

Flex Handle 1/4" Drive

- Provides extra leverage for breaking loose rusted or high torque fasteners
- Smooth action flex joint for hard-to-reach fasteners
- Knurled handle for secure grip
- Pivoting head allows the handle to avoid obstructions when being turned in a cramped space
- Chrome vanadium steel for long life and maximum corrosion resistance
- 6" length



LIFETIME WARRANTY*

Standard Extensions

- Chrome vanadium steel, heat-treated

1/4" Drive

KT121002 - 2" Extension

KT121004 - 4" Extension

KT121006 - 6" Extension



LIFETIME WARRANTY*

KT121010 - 10" Extension

KT121014 - 14" Extension

KT121040

Wobble Extension Set 1/4" Drive

- Chrome vanadium steel, heat-treated • Available individually

Set includes (also available individually):

KT121043 - 4" Wobble Extension

KT121046 - 6" Wobble Extension

KT121048 - 9" Wobble Extension



LIFETIME WARRANTY*

KT121055

1/4" Female to 3/8" Male Chrome Socket Adapter

- Chrome vanadium steel, heat treated



LIFETIME WARRANTY*

KT121050

1/4" Drive Universal Joint

- Chrome vanadium steel, heat treated
- Carded



LIFETIME WARRANTY*

3/8" Chrome | Accessories 3/8"



LIFETIME WARRANTY*

KT122091 3/8" Drive Push Button Ratchet

- High polish chrome finish, chrome vanadium steel



Professional Series Ratchets

- High-polished chrome
- Push-button design socket release
- Thumb lever directional switch
- Fine-tooth thin design with knurled handles

LIFETIME WARRANTY*



3/8" Drive

KT122092* - 7-7/8" Pro Series

KT122093 - 10½" Flex Head

KT122095 - 11-3/8" Long Handle

KT122092RK - Repair Kit



KT122070 3/8" Drive Speed T-Handle

- Aluminum sleeve for fast turning
- Locking end to hold socket securely in place
- Pivoting end to reach odd angles
- 3/8" drive end for use with a ratchet - use like an extension

LIFETIME WARRANTY*



LIFETIME WARRANTY*

KT122080 Flex Handle 3/8" Drive 8" Overall Length

- High polish chrome finish, chrome vanadium steel
- Provides extra leverage for breaking loose rusted or high torque fasteners
- Smooth action flex joint for hard-to-reach fasteners
- Knurled handle for secure grip
- Pivoting head allows the handle to avoid obstructions when being turned in a cramped space
- Chrome vanadium steel for long life and maximum corrosion resistance



KT122071 Speed Handle 3/8" Drive

- Speed handle is designed to reach tough access points that a standard ratchet cannot reach
- Tightens or removes a variety of fasteners
- Lightweight design makes any job quick and easy

LIFETIME WARRANTY*

KT122071A - Speed Handle 3/8" Drive, Ext 6.4"



3/8" Drive Standard Extensions

- Chrome vanadium steel, heat-treated

LIFETIME WARRANTY*

KT122002 - 2" Extension

KT122005 - 5" Extension

KT122008 - 8" Extension

KT122012 - 12" Extension

KT122024 - 24" Extension

KT122003 - 3" Extension

KT122006 - 6" Extension

KT122010 - 10" Extension

KT122018 - 18" Extension



KT122041 Wobble Extension Set 3/8" Drive

- Chrome vanadium steel, heat-treated. Available individually.

Set includes (also available individually):

KT122043 - 3" Wobble Extension

KT122046 - 6" Wobble Extension

KT122048 - 8" Wobble Extension

LIFETIME WARRANTY*

KT122060 3/8" Female to 1/4" Male Socket Adapter

- Chrome vanadium steel, heat-treated



KT122055 3/8" Female to 1/2" Male Socket Adapter

- Chrome vanadium steel, heat-treated



KT122500 3/8" Drive Socket Universal Joint

- Chrome vanadium steel, heat-treated
- Carded

LIFETIME WARRANTY*



HAND TOOLS

1/2" Chrome | Accessories 1/2"



KT123091

1/2" Drive Push Button Ratchet

- High polish chrome finish
- Chrome vanadium steel
- Premium gears
- 9-7/8" in length

LIFETIME WARRANTY*



1/2" Drive

Professional Series Chrome Ratchet

- High-polished chrome
- Push-button design socket release
- Thumb lever directional switch
- Fine-tooth thin design
- Knurled handles

KT123092* - 9-7/8" Long Handle

KT123095 - 15" Long Handle

KT123092RK

LIFETIME WARRANTY*



KT123070

1/2" Sliding T-Handle

- Made with high-polish, chrome vanadium steel
- Allows you accessibility to hard-to-reach areas

LIFETIME WARRANTY*



Flex Handle

- Provides extra leverage for breaking loose rusted or high torque fasteners
- Smooth action flex joint for hard-to-reach fasteners
- Knurled handle for secure grip
- Pivoting head allows the handle to avoid obstructions when being turned in a cramped space
- Chrome vanadium steel for long life and maximum corrosion resistance

LIFETIME WARRANTY*

1/2" Drive

KT123080 - 17" Flex Handle

KT123081 - 24" Flex Handle

KT123082 - 18" to 25" Extending Flex Handle

KT123083 - 10" Flex Handle



1/2" Drive

Standard Extensions

- Chrome vanadium steel, heat-treated.

LIFETIME WARRANTY*

KT123003 - 3" Extension

KT123010 - 10" Extension

KT123020 - 20" Extension

KT123005 - 5" Extension

KT123015 - 15" Extension

Reducers and Adapters

- Chrome vanadium steel, heat-treated.

KT122050 - 1/2" Female to 3/8" Male

KT122075 - 1/2" Female to 3/4" Male



KT123500

1/2" Drive Socket Universal Joint

- Chrome vanadium steel, heat treated
- Carded



LIFETIME WARRANTY*

KT123248

Heating Element Socket 1/2" Drive

- 1/2" drive 1-1/2" deep socket
- Fits heating element in many electric water heaters



LIFETIME WARRANTY*

3/4" Chrome | Accessories 3/4"



LIFETIME WARRANTY*

KT124090

3/4" Drive Ratchet

- Push button release
- High polish chrome finish, chrome vanadium steel, premium gears
- 19-7/8" length



KT124090RK - 3/4" Drive Ratchet Repair Kit



KT124092

3/4" Drive

Professional Series Chrome Ratchet

- Lightweight alloy handle for ease of use
- High polished chrome
- New design push button socket release
- Thumb lever directional switch
- Fine tooth thin design
- Knurled handle
- 19-5/8" length

LIFETIME WARRANTY*



3/4" Chrome I Accessories 3/4"



LIFETIME WARRANTY*

KTi24080

3/4" Drive Flex Head Breaker Bar - 20"

- Extra leverage for breaking loose rusted or high torque fasteners
- Features high polish chrome finish, knurled handle for sure grip and ball detent to fasten socket to handle without slippage



3/4" Drive Standard Extensions

- Chrome vanadium steel, heat-treated

- KTi24004 - 4" Extension
- KTi24008 - 8" Extension
- KTi24016 - 16" Extension

LIFETIME WARRANTY*



KTi24070

3/4" Drive Sliding T-Handle Socket

- Made with high polish, chrome vanadium steel
- Allows you accessibility to hard to reach areas

LIFETIME WARRANTY*

KTi24070B

Sliding T-Handle 3/4" Black Finish

- Black oxide finish

LIFETIME WARRANTY*

KTi24500

3/4" Drive Universal Joint

- Chrome vanadium steel, heat treated for wear and resistance
- Built for rugged, professional environments
- Laser engraved for easy identification

LIFETIME WARRANTY*



KTi24050

3/4" Female to 1/2" Male Socket Adapter

- Chrome vanadium steel, heat treated for wear and resistance
- Laser engraved



LIFETIME WARRANTY*

3/8" Impact I Accessories 3/8"

KTi32016

3/8" Female 1/2" Male Impact Socket Adapter

- Heat treated



LIFETIME WARRANTY*

KTi32012

3/8" Drive Impact Socket Universal Joint

- Chrome moly steel, heat treated, short overall length



LIFETIME WARRANTY*

KTi32003

3/8" Drive Impact Extension, 3" Long

LIFETIME WARRANTY*



1/2" Impact I Accessories 1/2"

Impact Reducers and Adapters

- Heat-treated



KTi33012 - 1/2" female x 3/8" male

KTi33041 - 1/2" female x 3/8" male (wobble)

KTi33024 - 1/2" female x 3/4" male

LIFETIME WARRANTY*

KTi33016

1/2" Drive Impact Socket Universal Joint

- Chrome moly steel, heat treated, short overall length



LIFETIME WARRANTY*

1/2" Drive Impact Socket Extension

- Features ball detent for easy removal
- Heat-treated chrome-moly steel

KTi33003 - 3"

KTi33006 - 6"

LIFETIME WARRANTY*



HAND TOOLS

3/4" Impact | 3/4" Accessories

Impact Reducers and Adapters

- Heat-treated



- KTI34016 - 3/4" female x 1/2" male
- KTI34032 - 3/4" female x 1" male
- KTI24085 - 3/4" ratcheting

LIFETIME WARRANTY*

KTI34050 3/4" Drive Impact Socket Universal Joint

- Ball/swivel action universal joints give sockets access to tight areas.
- Heat-treated chrome-moly steel
- Laser etched for quick identification



LIFETIME WARRANTY*

1" Impact | 1" Accessories

KTI35024 1" Female 3/4" Male Impact Socket Adapter

- Black oxide finish
- Ball retainer style



LIFETIME WARRANTY*

1" Drive Impact Extension

- KTI35007 - 7"
- KTI35013 - 13"

LIFETIME WARRANTY*



Torx/Torq/Hex Sockets | Sets

KTI22970 7-Piece Fractional Hex Bit Set 3/8" Drive

- Chrome vanadium steel, heat-treated
 - Packaged on a socket rail
- Includes 7 pieces 1/8" through 3/8"



LIFETIME WARRANTY*

Set includes (also available individually):

- KTI22904 - 1/8" Hex Bit
- KTI22905 - 5/32" Hex Bit
- KTI22906 - 3/16" Hex Bit
- KTI22907 - 7/32" Hex Bit

- KTI22908 - 1/4" Hex Bit
- KTI22910 - 5/16" Hex Bit
- KTI22912 - 3/8" Hex Bit

KTI27970 7-Piece Metric Hex Bit Set 3/8" Drive

- Chrome vanadium steel, heat-treated
 - Packaged on a socket rail
- Includes 7 pieces 3mm through 10mm



LIFETIME WARRANTY*

Set includes (also available individually):

- KTI27903 - 3mm Hex Bit
- KTI27904 - 4mm Hex Bit
- KTI27905 - 5mm Hex Bit
- KTI27906 - 6mm Hex Bit

- KTI27907 - 7mm Hex Bit
- KTI27908 - 8mm Hex Bit
- KTI27910 - 10mm Hex Bit

KTI27955 3/8" Drive, 5.5mm Hex Bit Socket

- Made of chrome vanadium steel and heat treated for durability

LIFETIME WARRANTY*

KTI27902 3-Piece Metric Brake Caliper Set 3/8" Drive

- Use on disc brake calipers to remove and install brake pads
 - Disk brake caliper set features hardened and tempered chrome vanadium steel sockets with professional sand finish
 - Bits are heat-treated and precision machined
- Includes: 7mm, 8mm and 10mm hex bits. Available for individual purchase.



Set includes (also available individually):

- KTI27907 - 7mm Hex Bit
- KTI27908 - 8mm Hex Bit
- KTI27910 - 10mm Hex Bit

LIFETIME WARRANTY*

KTI22902 3-Piece Fractional Brake Caliper Set 3/8" Drive

- Use on disc brake calipers to remove and install brake pads
 - Disk brake caliper set features hardened and tempered chrome vanadium steel sockets with professional sand finish
 - Bits are heat-treated and precision machined
- Includes: 1/4", 5/16" and 3/8" hex bits. Available for individual purchase



Set includes (also available individually):

- KTI22908 - 1/4" Hex Bit
- KTI22910 - 5/16" Hex Bit
- KTI22912 - 3/8" Hex Bit

LIFETIME WARRANTY*

Torx/Torq/Hex Sockets | Sets

KTI22802 3-Piece Brake

LIFETIME WARRANTY*



Caliper Torq Bit Set 3/8" Drive

- Use on disc brake calipers to remove and install brake pads
- Fits most GM and Ford brake caliper torx bolts
- Bits are heat-treated and precision machined

Includes: T-40, T-45 and T-50 Torq bits

Set includes (also available individually):

KTI22840 - T40 Internal Torq

KTI22845 - T45 Internal Torq

KTI22850 - T50 Internal Torq



KTI22671

10-Piece External Torx Socket Set

- Chrome vanadium steel, heat-treated
- Packaged on a socket rail

Set includes (also available individually):

1/4" Drive

KTI22675 - E5 External Torx

KTI22676 - E6 External Torx

KTI22677 - E7 External Torx

KTI22678 - E8 External Torx

1/2" Drive

KTI22688 - E18 External Torx

KTI22689 - E20 External Torx

3/8" Drive

KTI22680 - E10 External Torx

KTI22682 - E12 External Torx

KTI22684 - E14 External Torx

KTI22686 - E16 External Torx



LIFETIME WARRANTY*



KTI22870

10-Piece External Torq Socket Set

- Chrome vanadium steel, heat-treated
- Packaged on a socket rail

Set includes (also available individually):

1/4" Drive

KTI22874 - E4 External Torq

KTI22875 - E5 External Torq

KTI22876 - E6 External Torq

KTI22877 - E7 External Torq

KTI22878 - E8 External Torq

3/8" Drive

KTI22880 - E10 External Torq

KTI22882 - E12 External Torq

KTI22884 - E14 External Torq

KTI22886 - E16 External Torq

KTI22888 - E18 External Torq

LIFETIME WARRANTY*

Torx/Torq Impact Sockets - External

U.S.A. - Torx

1/4" Drive		3/8" Drive		1/2" Drive	
Size	Part #	Size	Part #	Size	Part #
E5	KTI22675	E10	KTI22680	E18	KTI22688
E6	KTI22676	E12	KTI22682	E20	KTI22689
E7	KTI22677	E14	KTI22684		
E8	KTI22678	E16	KTI22686		

Import - Torque

1/4" Drive		3/8" Drive			
Size	Part #	Size	Part #		
E4	KTI22874	E10	KTI22880		
E5	KTI22875	E12	KTI22882		
E6	KTI22876	E14	KTI22884		
E7	KTI22877	E16	KTI22886		
E8	KTI22878	E18	KTI22888		

KTI22601 12-Piece Internal Torx Socket Set

- Heat-treated alloy steel
- Vinyl holder
- U.S.A. made



LIFETIME WARRANTY*

Set includes (also available individually):

1/4" Drive

KTI21610 - T10 Internal Torx

KTI21615 - T15 Internal Torx

KTI21620 - T20 Internal Torx

KTI21625 - T25 Internal Torx

KTI21627 - T27 Internal Torx

KTI21630 - T30 Internal Torx

3/8" Drive

KTI22640 - T40 Internal Torx

KTI22645 - T45 Internal Torx

KTI22647 - T47 Internal Torx

KTI22650 - T50 Internal Torx

KTI22655 - T55 Internal Torx

1/2" Drive

KTI22660 - T60 Internal Torx

KTI22600 9-Piece Internal Torx Socket Set

- Heat-treated alloy steel
- Vinyl holder
- U.S.A. made



LIFETIME WARRANTY*

Set includes (also available individually):

1/4" Drive

KTI21610 - T10 Internal Torx

KTI21615 - T15 Internal Torx

KTI21620 - T20 Internal Torx

KTI21625 - T25 Internal Torx

KTI21627 - T27 Internal Torx

KTI21630 - T30 Internal Torx

3/8" Drive

KTI22640 - T-40 Internal Torx

KTI22645 - T-45 Internal Torx

KTI22650 - T-50 Internal Torx

HAND TOOLS

Torx/Torq | Sets

KTI22801 12-Piece Internal Torq Socket Set

- Chrome vanadium steel, heat-treated
- Carded on socket rail



LIFETIME WARRANTY*

Set includes (also available individually):

1/4" Drive

- KTI21810 - T10 Internal Torq
- KTI21815 - T15 Internal Torq
- KTI21820 - T20 Internal Torq
- KTI21825 - T25 Internal Torq
- KTI21827 - T27 Internal Torq
- KTI21830 - T30 Internal Torq

3/8" Drive

- KTI22840 - T40 Internal Torq
- KTI22845 - T45 Internal Torq
- KTI22847 - T47 Internal Torq
- KTI22850 - T50 Internal Torq
- KTI22855 - T55 Internal Torq
- KTI22860 - T60 Internal Torq

KTI22800 9-Piece Internal Torq Socket Set

- Chrome vanadium steel, heat-treated
- Carded on socket rail



LIFETIME WARRANTY*

Set includes (also available individually):

1/4" Drive

- KTI21810 - T10 Internal Torq
- KTI21815 - T15 Internal Torq
- KTI21820 - T20 Internal Torq
- KTI21825 - T25 Internal Torq
- KTI21827 - T27 Internal Torq
- KTI21830 - T30 Internal Torq

3/8" Drive

- KTI22840 - T40 Internal Torq
- KTI22845 - T45 Internal Torq
- KTI22850 - T50 Internal Torq

KTI21500 10-Piece

Tamper-Proof Torx Socket Set

- Heat-treated alloy steel
- Vinyl holder
- U.S.A. made



LIFETIME WARRANTY*

Set includes (also available individually):

1/4" Drive

- KTI21510 - T10 Tamper-proof
- KTI21515 - T15 Tamper-proof
- KTI21520 - T20 Tamper-proof
- KTI21525 - T25 Tamper-proof
- KTI21527 - T27 Tamper-proof
- KTI21530 - T30 Tamper-proof
- KTI18008 - Bit Holder (T10-T30)

3/8" Drive

- KTI21540 - T40 Tamper-proof
- KTI21545 - T45 Tamper-proof
- KTI21550 - T50 Tamper-proof
- KTI21555 - T55 Tamper-proof
- KTI18012 - Bit Holder (T40-T60)

Torx Impact Sockets - Tamperproof

1/4" Drive		3/8" Drive	
Size	Part #	Size	Part #
T10	KTI21510	T40	KTI21540
T15	KTI21515	T45	KTI21545
T20	KTI21520	T50	KTI21550
T25	KTI21525	T55	KTI21555
T27	KTI21527		
T30	KTI21530		

Torx/Torq Impact Sockets - Internal

U.S.A. - Torx

1/4" Drive		3/8" Drive		1/2" Drive	
Size	Part #	Size	Part #	Size	Part #
T10	KTI21610	T40	KTI22640	T60	KTI22660
T15	KTI21615	T45	KTI22645	T70	KTI22670
T20	KTI21620	T47	KTI22647		
T25	KTI21625	T50	KTI22650		
T27	KTI21627	T55	KTI22655		
T30	KTI21630				

Import - Torque

1/4" Drive		3/8" Drive	
Size	Part #	Size	Part #
T10	KTI21810	T40	KTI22840
T15	KTI21815	T45	KTI22845
T20	KTI21820	T47	KTI22847
T25	KTI21825	T50	KTI22850
T27	KTI21827	T55	KTI22855
T30	KTI21830	T60	KTI22860



**HEAVY WEIGHT QUALITY.
KNOCKOUT PRICE.**

Hex Keys | Sets

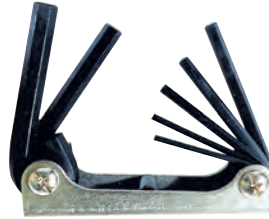

KT171400

7-Piece Folding Hex Bit Set Fractional

- Fold-up sets include a variety of popular sizes in one convenient handle
- Fold a key out to a right angle to get maximum leverage
- Fold a key out completely to operate like a screwdriver
- Fold-up sets are compact and easily fit in your pocket or tool box

Includes 1/8" to 3/8" fractional sizes

LIFETIME WARRANTY*

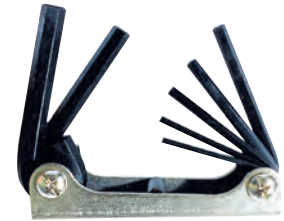

KT171475

7-Piece Folding Hex Key Set Metric

- Fold-up sets include a variety of popular sizes in one convenient handle
- Fold a key out to a right angle to get maximum leverage
- Fold a key out completely to operate like a screwdriver
- Fold-up sets are compact and easily fit in your pocket or tool box

Includes 2.5mm to 10mm metric sizes

LIFETIME WARRANTY*



KT171420

10-Piece Hex Key Set on Ring Fractional

- Hex keys featuring quality workmanship and value
- Manufactured with heat-treated alloy steel with black finish
- Precision formed to exact dimensional tolerances for precise fit
- Carded on a ring

Includes fractional "L" hex sizes from 1/16" to 3/8"

LIFETIME WARRANTY*



KT171480

10-piece Hex Key Set on Ring Metric

- Hex keys featuring quality workmanship and value
- Manufactured with heat-treated alloy steel with black finish
- Precision formed to exact dimensional tolerances for precise fit
- Carded on a ring

Includes metric "L" hex sizes from 1.5mm to 10mm

LIFETIME WARRANTY*

KT171425

25-Piece Hex Key Set (in pouch)

- Hex keys featuring quality workmanship and value
- Set features a convenient package design that provides easy transport and storage
- Manufactured with heat-treated alloy steel with black finish
- Precision formed to exact dimensional tolerances for precise fit
- Packaged in roll-up storage pouch

Includes: long fractional "L" hex sizes from 1/16" to 3/8" and short metric "L" hex sizes from 1.5mm to 10mm

LIFETIME WARRANTY*

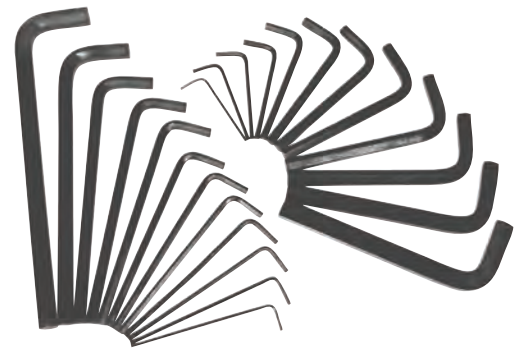

HAND TOOLS

Screwdrivers | Sets



KTI11035

34 Piece Screwdriver Set

• Made of Chrome Vanadium steel

Includes: 7 Phillips (#3x6", #2x4", #1x6", #1x3", #0x4", #0x3", #2x1-1/2"), 8 Slotted (5/16"x6", 1/4"x4", 3/16"x6", 3/16"x3", 5/32"x4", 1/8"x4", 1/8"x3", 1/4"x1-1/2"), 4 Torx (T10x4", T15x4", T20x4", T25x4"), 2 Square (S1x4", S2x4"), Bits Driver, 12 Bits (4 Slotted 1/8", 5/32", 3/16", 1/4"; 4 Phillips #0, #1, #2, #3; 4 Torx T10, T15, T20, T25)

KTI11226 - Phillips #3 x 6"

KTI11224 - Phillips #2 x 4"

KTI11230 - Phillips #1 x 6"

KTI11223 - Phillips #1 x 3"

KTI11231 - Phillips #0 x 4"

KTI11229 - Phillips #0 x 3"

KTI11221 - Phillips #2 x 1-1/2"

KTI11009 - Slotted 5/16" x 6"

KTI11011 - Slotted 1/4" x 4"

KTI11006 - Slotted 3/16" x 6"

KTI11012 - Slotted 3/16" x 3"

KTI11005 - Slotted 5/32" x 4"

KTI11004 - Slotted 1/8" x 4"

KTI11003 - Slotted 1/8" x 3"

KTI11010 - Slotted 1/4" x 1-1/2"

KTI11211 - Torx T10 x 4"

KTI11215 - Torx T15 x 4"

KTI11220 - Torx T20 X 4"

KTI11225 - Torx T25 x 4"

KTI11001 - Square S1" x 4"

KTI11002 - Square S2" x 4"

KTI18000 - Bits Set 12 Piece

KTI18009 - Bits Driver

KTI18904 - Slotted 1/8"

KTI18905 - Slotted 5/32"

KTI18906 - Slotted 3/16"

KTI18907 - Slotted 1/4"

KTI18900 - Phillips #0

KTI18901 - Phillips #1

KTI18902 - Phillips #2

KTI18903 - Phillips #3

KTI18910 - Torx T10

KTI18915 - Torx T15

KTI18920 - Torx T20

KTI18925 - Torx T25

KTI11018

18 Piece Screwdriver Set

• Made of Chrome Vanadium steel

Includes: 4 Slotted (5/16"x6", 1/4"x4", 3/16"x3", 1/4"x1-1/2"), 4 Phillips (#3x6", #2x4", #1x3", #2x1-1/2"), 10 Precision (6 Torx T5x1-9/16", T6x1-9/16", T7x1-9/16", T8x1-9/16", T9x1-9/16", T10x1-9/16"; 2 Slotted 3/32"x1-9/16", 1/8"x1-9/16"; 2 Phillips #0x1-9/16", #00x1-9/16")



KTI11009 - Slotted 5/16" x 6"

KTI11011 - Slotted 1/4" x 4"

KTI11012 - Slotted 3/16" x 3"

KTI11010 - Slotted 1/4" x 1-1/2"

KTI11226 - Phillips #3 x 6"

KTI11224 - Phillips #2 x 4"

KTI11223 - Phillips #1 x 3"

KTI11221 - Phillips #2 x 1-1/2"

KTI11205 - Torx Precision T5 x 1-9/16"

KTI11206 - Torx Precision T6 x 1-9/16"

KTI11207 - Torx Precision T7 x 1-9/16"

KTI11208 - Torx Precision T8 x 1-9/16"

KTI11209 - Torx Precision T9 x 1-9/16"

KTI11210 - Torx Precision T10 x 1-9/16"

KTI11201 - Slotted Precision 3/32" x 1-9/16"

KTI11202 - Slotted Precision 1/8" x 1-9/16"

KTI11203 - Phillips Precision #0 x 1-9/16"

KTI11204 - Phillips Precision #00 x 1-9/16"

KTI11008

8 Piece Screwdriver Set

• Made of Chrome Vanadium steel

Includes: 4 Slotted (5/16"x6", 3/16"x4", 1/8"x3", 1/4"x1-1/2"), 4 Phillips (#2x6", #1x4", #0x3", #2x1-1/2")



KTI11009 - Slotted 5/16" x 6"

KTI11007 - Slotted 3/16" x 4"

KTI11003 - Slotted 1/8" x 3"

KTI11010 - Slotted 1/4" x 1-1/2"

KTI11227 - Phillips #2 x 6"

KTI11228 - Phillips #1 x 4"

KTI11229 - Phillips #0 x 3"

KTI11221 - Phillips #2 x 1-1/2"

LIFETIME WARRANTY*

LIFETIME WARRANTY*

Screwdrivers | Sets

KTI16000

10-Piece Professional Screwdriver Set

- Ten-piece professional screwdriver set includes the perfect assortment of slotted and Phillips screwdrivers for a variety of projects
- Comfortable triangular grip, non-slip material and chrome vanadium blades
- Ultimate professional quality

Includes: 3" slotted, 4" slotted, 6" slotted, 8" slotted and 1-1/2" stubby slotted and #1 Phillips, #3 Phillips, #2 x 4" Phillips, #2 x 10" Phillips and 1-1/2" stubby Phillips. Also sold in 5-piece slotted set, 5-piece Phillips set or individually.

Available in sets or individually:

- KTI16001** - 5-piece Slotted Set
- KTI16201** - stubby slotted
- KTI16203** - 3" slotted
- KTI16204** - 4" slotted
- KTI16206** - 6" slotted
- KTI16208** - 8" slotted



LIFETIME WARRANTY*



- KTI16002** - 5-piece Phillips Set
- KTI16113** - #1 Phillips 3"
- KTI16121** - #2 Phillips Stubby 1.5"
- KTI16124** - #2 Phillips 4"
- KTI16129** - #2 Phillips 10"
- KTI16136** - #3 Phillips 6"

LIFETIME WARRANTY*

LIFETIME WARRANTY*

KTI19000

8-Piece Black Screwdriver Set

- Feature high quality chrome vanadium blades, heavy-duty colored handles and hex bolsters for wrench assist
- Packaged with plastic tray • Black handles

Includes: 1# Phillips 3" blade; #2 Phillips 1-1/2" stubby; #2 Phillips 4" blade; stubby slotted; 3" slotted; 4" slotted; 6" slotted; 8" slotted

Set includes (also available individually):

- KTI19113** - #1 Phillips 3"
- KTI19121** - #2 Phillips Stubby
- KTI19124** - #2 Phillips 4"
- KTI19201** - Stubby slotted
- KTI19203** - 3" slotted
- KTI19204** - 4" slotted
- KTI19206** - 6" slotted
- KTI19208** - 8" slotted



LIFETIME WARRANTY*

KTI19700

8-Piece Orange Screwdriver Set

- Feature high quality chrome vanadium blades, heavy-duty colored handles and hex bolsters for wrench assist
- Packaged with plastic tray • Orange handles

Includes: 1# Phillips 3" blade; #2 Phillips 1-1/2" stubby; #2 Phillips 4" blade; stubby slotted; 3" slotted; 4" slotted; 6" slotted; 8" slotted

Set includes (also available individually):

- KTI19713** - #1 Phillips 3"
- KTI19721** - #2 Phillips Stubby
- KTI19724** - #2 Phillips 4"
- KTI19701** - Stubby slotted
- KTI19703** - 3" slotted
- KTI19704** - 4" slotted
- KTI19706** - 6" slotted
- KTI19708** - 8" slotted



LIFETIME WARRANTY*

KTI19800

8-Piece Red Screwdriver Set

- Feature high quality chrome vanadium blades, heavy-duty colored handles and hex bolsters for wrench assist
- Packaged with plastic tray • Red handles

Includes: 1# Phillips 3" blade; #2 Phillips 1-1/2" stubby; #2 Phillips 4" blade; stubby slotted; 3" slotted; 4" slotted; 6" slotted; 8" slotted

Set includes (also available individually):

- KTI19813** - #1 Phillips 3"
- KTI19821** - #2 Phillips Stubby
- KTI19824** - #2 Phillips 4"
- KTI19801** - Stubby slotted
- KTI19803** - 3" slotted
- KTI19804** - 4" slotted
- KTI19806** - 6" slotted
- KTI19808** - 8" slotted



LIFETIME WARRANTY*

KTI19900

8-Piece Green Screwdriver Set

- Feature high quality chrome vanadium blades, heavy-duty colored handles and hex bolsters for wrench assist
- Packaged with plastic tray • Green handles

Includes: 1# Phillips 3" blade; #2 Phillips 1-1/2" stubby; #2 Phillips 4" blade; stubby slotted; 3" slotted; 4" slotted; 6" slotted; 8" slotted.

Set includes (also available individually):

- KTI19913** - #1 Phillips 3"
- KTI19921** - #2 Phillips Stubby
- KTI19924** - #2 Phillips 4"
- KTI19901** - Stubby slotted
- KTI19903** - 3" slotted
- KTI19904** - 4" slotted
- KTI19906** - 6" slotted
- KTI19908** - 8" slotted



HAND TOOLS

Screwdrivers | Sets

KTI11100

Interchangeable Screwdriver Set

- Features three dual-sided interchangeable inserts - 3 slotted, 3 phillips bits
 - Each screwdriver bit boasts a 2-5/8" blade at each end (6" overall bit length) and a hex bolster for wrench assist (7/16" fractional or 11mm metric)
 - Plastic contoured handle for maximum torque and comfort
 - Anodized alloy shank for high durability
 - Rubber o-ring provides a secure, non-slip grip
- Includes: #1 phillips and 3/16" slotted; #2 phillips and 1/4" slotted; #3 phillips and 5/16" slotted. Storage pouch for convenience and flexibility.

LIFETIME WARRANTY*



KTI11110

Pocket Screwdriver

- 5-3/16" length
- 1/8" blade width
- Easy to grip handle
- Polished steel



LIFETIME WARRANTY*



KTI14219

19" Jumbo Screwdriver

- Features a 19" x 1/2" blade
- Extra large handles and shafts for use on hard to reach areas of large machinery, farm equipment, manufacturing equipment, automobiles and more
- Square shank allows for use with wrenches for larger torque jobs
- Black oxide finish

LIFETIME WARRANTY*



KTI72180

1/4" Female Adjustable Torque Screwdriver

- Screwdriver handle contains viewable torque scale 5-40 inch-pounds (.504 Nm)
- 1/4" Female hex
- Heavy duty black plastic storage case included

Torq Screwdrivers

- Large grip handle and chrome vanadium blades make light work of headlight and trim screws

Sold separately:

KTI11310 - T10 Torq screwdriver

KTI11315 - T15 Torq screwdriver

KTI11320 - T20 Torq screwdriver

LIFETIME WARRANTY*



KTI19138

8" Black Screwdriver #4 Phillips

- #4 Phillips Screwdriver
- Sturdy, black handle
- 8" Length

LIFETIME WARRANTY*



W*

KTIPREPACKQ1

Hand Tools Floor Display Prepack Q1

- Floor Display consisting of five prepacked KTI hand tool sets (2 each)
- (2) KTI19000 - 8Pc Screwdriver Set (Black)
- (2) KTI21044 - 44Pc Socket Set, 1/4" Drive, SAE & Metric, Shallow & Deep
- (2) KTI22047 - 47Pc Socket Set, 6 Point, 3/8" Drive SAE & Metric
- Two Wrench Sets; (2) KTI41300 - 9pc High Polish, Smooth Finish, Sizes 3/8" to 7/8" and (2) KTI41800 - 13Pc High Polish, Smooth Finish, Sizes 7mm to 19mm

Display setup size: Height: 40.9", Width: 26.3", Depth: 16.7".

All hand tools are covered by a Lifetime Warranty.



Nut Drivers | Sets



KT114400 7-Piece Fractional Nut Driver Set

**LIFETIME
WARRANTY***

- Rugged and designed for shop environments, tools feature hollow shafts, ergonomic soft grip handles, and alloy steel sockets and shafts
- Set is color coded for easy identification
- Tools packaged in handy plastic hanging organizer

Includes sizes: 3/16" x 3", 1/4" x 3", 5/16" x 3", 11/32" x 3", 3/8" x 3", 7/16" x 3" and 1/2" x 3"

Set includes (also available individually):

KT114406 - 3/16" x 3"
KT114408 - 1/4" x 3"
KT114410 - 5/16" x 3"
KT114411 - 11/32" x 3"

KT114412 - 3/8" x 3"
KT114414 - 7/16" x 3"
KT114416 - 1/2" x 3"



**LIFETIME
WARRANTY***

KT114500 7-Piece Metric Nut Driver Set

- Rugged and designed for shop environments
- Feature hollow shafts, ergonomic soft grip handles and alloy steel sockets and shafts
- Set is color coded for easy identification
- Tools packaged in handy plastic hanging organizer

Includes sizes: 5 mm x 75, 6 mm x 75, 7 mm x 75, 8 mm x 75, 9 mm x 75, 10 mm x 75 and 11 mm x 75

Set includes (also available individually):

KT114505 - 5mm x 75mm
KT114506 - 6mm x 75mm
KT114507 - 7mm x 75mm
KT114508 - 8mm x 75mm

KT114509 - 9mm x 75mm
KT114510 - 10mm x 75mm
KT114511 - 11mm x 75mm

Nut Drivers			
Fractional		Metric	
Part #	Size	Part #	Size
KT114406	3/16" x 3"	KT114505	5mm x 75mm
KT114408	1/4" x 3"	KT114506	6mm x 75mm
KT114410	5/16" x 3"	KT114507	7mm x 75mm
KT114411	11/32" x 3"	KT114508	8mm x 75mm
KT114412	3/8" x 3"	KT114509	9mm x 75mm
KT114414	7/16" x 3"	KT114510	10mm x 75mm
KT114416	1/2" x 3"	KT114511	11mm x 75mm

Hooks, Picks, & Awls | Sets



KT170070 4-Piece Pick Set with Neon Orange Handles

- Includes four picks for removing, installing, aligning, probing and piercing
- Use to ease removal of O-rings, split pins, seals and bushes and loose parts
- Set contains orange-handled straight, 45°, 90° and hook picks.

Set includes (also available individually):

KT170071 - Straight Neon Orange Pick
KT170072 - 45 Degree Neon Orange Pick
KT170073 - 90 Degree Neon Orange Pick
KT170074 - Hook Neon Orange Pick

**LIFETIME
WARRANTY***



KT170075 4-Piece Pick Set with Neon Green Handles

- Includes four picks for removing, installing, aligning, probing and piercing
- Use to ease removal of O-rings, split pins, seals and bushes and loose parts
- Set contains green-handled straight, 45°, 90° and hook picks

Set includes (also available individually):

KT170076 - Straight Neon Green Pick
KT170077 - 45 Degree Neon Green Pick
KT170078 - 90 Degree Neon Green Pick
KT170079 - Neon Green Hook Pick

**LIFETIME
WARRANTY***

HAND TOOLS

Pry Bars | Sets

KTI71600

4-Piece Pry Bar Set - Lady Slipper Style

- Superior quality, heat-treated pry bars
 - Tools feature high leverage rolling head and long tapered body to align drift
- Includes 6", 12", 16" and 20" pry bars.



LIFETIME WARRANTY*

Set includes (also available individually):

KTI71606 - 6"

KTI71612 - 12"

KTI71616 - 16"

KTI71620 - 20"

KTI19240

4-Piece Bent-End Pry Bar Set

- Tools feature smooth, comfortable square handles
 - Packaged in plastic formed box
- Includes: 9", 12", 18", 24"



LIFETIME WARRANTY*

Set includes (also available individually):

KTI19209 - 9"

KTI19212 - 12"

KTI19218 - 18"

KTI19224 - 24"

Scrapers | Sets

KTI70004

4-Piece Putty Knife / Scraper Set

- Use to apply adhesives, filler, compound, spackles and more
 - Ideal for removing paint, rust, gaskets, carbon, filler and undercoating
 - All blades are high carbon, heat-treated, tempered, polished to mirror finish and full tang
 - Tools fitted with grommeted brass, solvent-resistant, riveted wood handles
 - Features 15° sharp chisel edge on stiff scrapers
- Includes: 1" stiff edge; 1-1/2" stiff edge; 1-1/2" flex edge; and 3" flex edge



LIFETIME WARRANTY*

Set includes (also available individually):

KTI70014 - Scraper Putty Knife 1" Stiff

KTI70017 - Scraper Putty Knife 1-1/2" Flexible

KTI70015 - Scraper Putty Knife 1-1/2" Stiff

KTI70018 - Scraper Putty Knife 3" Flexible

KTI70005

4-Piece Putty Knife / Scraper Set

- Features a combination of flexible and stiff scrapers for the needs of any automotive body application or home improvement job
 - Constructed of stainless steel blades that taper at tip to provide great flexibility and blade action
 - Ergonomic, comfort-grip, non-slip handles
- Includes an upholstery tucking tool, 2" flexible scraper, 1.25" flexible scraper and 1.25" stiff chisel.



LIFETIME WARRANTY*

Set includes (also available individually):

KTI70006 - Putty Knife, Upholstery Tucking Tool with Stainless Steel Blade and Comfort Grip Handle

KTI70007 - Putty Knife, 2" Flexible with Stainless Steel Blade and Comfort Grip Handle

KTI70008 - Putty Knife, 1.25" Flexible with Stainless Steel Blade and Comfort Grip Handle

KTI70009 - Putty Knife, 1.25" Stiff Chisel with Stainless Steel Blade and Comfort Grip Handle

Scrapers | Sets



KTI70023 4-Piece Scraper Set

Set includes: stubby scraper; 1" carbon scraper; combination offset scraper; and 5/8" scraper. Also available individually.

Set includes (also available individually):

KTI70019 - Stubby Scraper

KTI70021 - 1" Carbon Scraper

KTI70022 - Combination Offset Scraper

KTI70027 - 5/8" Scraper

**LIFETIME
WARRANTY***

Scrapers/Putty Knives	
Part #	Type/Size
KTI70006	Putty Tucking
KTI70007	2" Flexible Putty
KTI70008	1-1/4" Flexible Putty
KTI70009	1-1/4" Stiff Putty
KTI70014	1" Stiff Putty
KTI70015	1-1/2" Stiff Putty
KTI70017	1-1/2" Flexible Putty
KTI70018	3" Flexible Putty
KTI70019	Stubby
KTI70020	1" Long Handled
KTI70021	1" Carbon Scraper
KTI70022	Combination Offset
KTI70024	3/4" Chisel
KTI70025	1-1/2" Flexible
KTI70026	1-1/2" Chisel
KTI70027	5/8" Scraper
KTI70028	Putty Knife
KTI70029	3" Flexible

Punches & Chisels | Sets



KTI72901 (in tray) or **KTI72901K** (in kit bag)

15-Piece Punch & Chisel Set

Set includes five pin punches, five taper punches, three chisels and two center punches. Packaged in your choice of plastic tray or kit bag. Components available individually.

KTI72901 (in tray) or **KTI72901K** (in kit bag)

**LIFETIME
WARRANTY***

Pin Punches Punches

KTI72911 - 3/32"

KTI72912 - 1/8"

KTI72913 - 5/32"

KTI72914 - 3/16"

KTI72915 - 1/4"

Taper

KTI72921 - 3/32"

KTI72922 - 1/8"

KTI72923 - 5/32"

KTI72924 - 3/16"

KTI72925 - 1/4"

Chisels

KTI73012 - 3/8"

KTI73016 - 1/2"

KTI73020 - 5/8"

Center Punches

KTI72931 - 1/8"

KTI72932 - 3/16"

KTI72900

6-Piece

Pin Punch Set

Sizes include: 3/32", 1/8", 5/32", 3/16", 1/4" and 5/16". Packaged in plastic tray. Available individually.

Set includes (also available individually):

KTI72911 - 3/32"

KTI72912 - 1/8"

KTI72913 - 5/32"

KTI72914 - 3/16"

KTI72915 - 1/4"

KTI72916 - 5/16"

**LIFETIME
WARRANTY***



KTI72980

4-Piece

Brass Punch Set

Set includes sizes: 3/8"; 1/2"; 5/8"; and 3/4". Tools feature knurled handles. Designed for rugged shop environment. Packaged in vinyl case.

Set includes (also available individually):

KTI72982 - 3/8" punch

KTI72984 - 1/2" punch

KTI72986 - 5/8" punch

KTI72988 - 3/4" punch



**LIFETIME
WARRANTY***



HAND TOOLS

Punches & Chisels | Sets

KT173000

5-piece Chisel Set

Sizes include: 3/8", 1/2", 5/8", 3/4" and 7/8".
Packaged in plastic tray. Available individually.



Set includes (also available individually):

KT173012 - 3/8"

KT173016 - 1/2"

KT173020 - 5/8"

KT173024 - 3/4"

KT173028 - 7/8"

LIFETIME WARRANTY*

Punches

Part #	Type	Size
KT172931	Center	1/8"
KT172932	Center	3/16"
KT170002	Center - Brass Automatic	
KT172921	Taper	3/32"
KT172922	Taper	1/8"
KT172923	Taper	5/32"
KT172924	Taper	3/16"
KT172925	Taper	1/4"
KT172911	Pin	3/32"
KT172912	Pin	1/8"
KT172913	Pin	5/32"
KT172914	Pin	3/16"
KT172915	Pin	1/4"
KT172916	Pin	5/16"
KT172982	Brass	3/8"
KT172984	Brass	1/2"
KT172986	Brass	5/8"
KT172988	Brass	3/4"

Chisels

Part #	Type	Size
KT173012	Flat Chisel	3/8"
KT173016	Flat Chisel	1/2"
KT173020	Flat Chisel	5/8"
KT173024	Flat Chisel	3/4"
KT173028	Flat Chisel	7/8"

LIFETIME WARRANTY*

KT172505

5-Piece File Set

Sets includes: 6" mill file; 10" mill file; 8" bastard file; 8" half-round file; and 8" round file.

Set includes (also available individually):

KT172512 - 6" mill file

KT172514 - 10" mill file

KT172523 - 8" bastard file

KT172543 - 8" half-round file

KT172553 - 8" round file

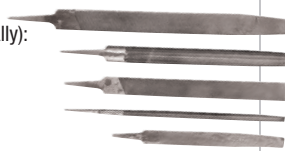

Wrenches | Combination Non-Ratcheting



KT41300

9-Piece

Wrench Set High Polish

Fractional 3/8" to 7/8"

- High-polish, smooth-finish, heat-treated chrome vanadium steel
- Tools are longer than standard combination wrenches to enable access to hard-to-reach places
- Wrenches sized from 3/8"-7/8"
- Packaged in kit bag. Available individually



LIFETIME WARRANTY*



KT41304

14-Piece Wrench Set

High Polish Fractional 3/8" to 1-1/4"

- Features high-polish, smooth-finish, heat-treated chrome vanadium steel
- Tools are longer than standard combination wrenches to enable access to hard-to-reach places
- Wrenches sized from 3/8"-1-1/4"
- Packaged in kit bag. Available individually.



LIFETIME WARRANTY*



Wrenches | **Combination Non-Ratcheting**



KTI41305

24-Piece

High Polish Combination Wrench Set

- Professional Series Fractional Wrench Set
- High-polish, smooth-finish, heat-treated chrome-vanadium steel
- Heavy duty pocketed roll pouch with two velcro bands
- Wrench sizes: 1/4", 5/16", 11/32", 3/8", 7/16", 1/2", 9/16", 5/8", 11/16", 3/4", 13/16", 7/8", 15/16", 1", 1-1/16", 1-1/8", 1-3/16", 1-1/4", 1-5/16", 1-3/8", 1-7/16", 1-1/2", 1-9/16" and 1-5/8"



KTI41301

12-Piece Combination Wrench Set

Set includes sizes: 5/16", 3/8", 7/16", 1/2", 9/16", 5/8", 11/16", 3/4", 13/16", 7/8", 15/16" & 1"



Raised Panel Metric Wrenches 12-point

- Made of drop forged steel, wrench is chrome-plated and heat-treated to achieve maximum wear
- A raised panel provides additional strength and durability
- All wrenches are marked with part number and size for ease of identification

Sold separately:	KTI41611 - 11mm	KTI41616 - 16mm
KTI41607 - 7mm	KTI41612 - 12mm	KTI41617 - 17mm
KTI41608 - 8mm	KTI41613 - 13mm	KTI41618 - 18mm
KTI41609 - 9mm	KTI41614 - 14mm	KTI41619 - 19mm
KTI41610 - 10mm	KTI41615 - 15mm	



KTI41800

13-Piece Professional Combination Wrench Set

High Polish Metric 7mm to 19mm

- Features high-polish, smooth-finish, heat-treated chrome vanadium steel
- Tools are longer than standard combination wrenches to enable access to hard-to-reach places
- Wrenches sized from 7mm-19mm.
- Packaged in kit bag. Available individually.



KTI41802

8-Piece Professional Combination Wrench Set

High Polish Metric 29mm to 36mm

- Features high-polish, smooth-finish, heat-treated chrome vanadium steel
- Tools are longer than standard combination wrenches to enable access to hard-to-reach places
- Wrenches sized from 29mm through 36mm. Available individually



KTI41200

7-Piece

Combination Wrench Set Fractional Short 3/8" to 3/4"

- High polish chrome vanadium steel
- Heat treated
- 12 point on box end
- Packaged in a plastic tray



Includes sizes: 3/8", 7/16", 1/2", 9/16", 5/8", 11/16", and 3/4" wrenches.

HAND TOOLS

Wrenches | Combination Non-Ratcheting



KT141801
9-Piece Professional
Combination Wrench Set
High Polish Metric 20mm to 28mm

- Features high-polish, smooth-finish, heat-treated chrome vanadium steel
- Tools are longer than standard combination wrenches to enable access to hard-to-reach places
- Wrenches sized from 20mm through 28mm.
- Also available individually.



KT141700
7-Piece Combination Wrench Set
Metric Short 10mm to 18mm

- High polish, smooth-finish, heat-treated chrome vanadium steel
 - 12 point hex on box end
 - Packaged in a plastic tray
- Sizes include: 10mm, 12mm, 13mm, 14mm, 15mm, 17mm, and 18mm wrenches



Open-end High Polish Wrenches

- Professional series fractional wrenches features high-polish, smooth-finish, heat-treated chrome vanadium steel.

Sold separately:

Fractional:

KT142316 - 1/2" x 9/16"

KT142318 - 9/16" x 5/8"



KT142320 - 5/8" x 3/4"

KT142348 - 1-1/2" x 1-5/8"

Metric:

KT142818 - 16mm x 18mmv



KT141011
11-Piece Combination Wrench Set
Raised Panel Fractional 3/8" to 1"

- Made of drop forged steel, wrenches are chrome-plated and heat-treated to achieve maximum wear
 - A raised panel provides additional strength and durability
 - Packaged in kit bag organizer. Available individually.
- Includes sizes 3/8", 7/16", 1/2", 9/16", 5/8", 11/16", 3/4", 13/16", 7/8", 15/16" and 1"



KT141013
13-Piece Combination Wrench Set
Raised Panel Fractional 1/4" to 1"

- Made of drop forged steel, wrenches are chrome-plated and heat-treated to achieve maximum wear
 - A raised panel provides additional strength and durability
 - Packaged in heavy duty kit bag organizer. Available individually.
- Includes sizes 1/4", 5/16", 3/8", 7/16", 1/2", 9/16", 5/8", 11/16", 3/4", 13/16", 7/8", 15/16" and 1"

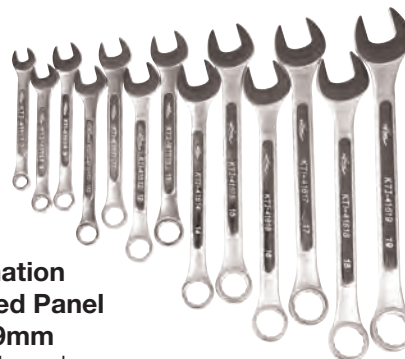

KT141513
13-Piece Combination
Wrench Set Raised Panel
Metric 7mm to 19mm

- Made of drop forged steel, wrenches are chrome-plated and heat-treated to achieve maximum wear
 - A raised panel provides additional strength and durability
 - Packaged in kit bag organizer. Available individually.
- Thirteen-piece metric set includes sizes 7mm, 8mm, 9mm, 10mm, 11mm, 12mm, 13mm, 14mm, 15mm, 16mm, 17mm, 18mm and 19mm



Wrenches | **Combination Non-Ratcheting**



KTI41014 14-Piece Combination Wrench Set Raised Panel Fractional 3/8" to 1-1/4"

- Made of drop forged steel, wrenches are chrome-plated and heat-treated to achieve maximum wear
 - A raised panel provides additional strength and durability
 - Packaged in kit bag organizer. Available individually.
- Includes sizes 3/8", 7/16", 1/2", 9/16", 5/8", 11/16", 3/4", 13/16", 7/8", 15/16", 1", 1-1/16", 1-1/8" and 1-1/4"



KTI41016 16-Piece Combination Wrench Set Raised Panel Fractional 1/4" to 1-1/4"

- Made of drop forged steel, wrenches are chrome-plated and heat-treated to achieve maximum wear
 - A raised panel provides additional strength and durability
 - Packaged in kit bag organizer. Available individually.
- Includes sizes 1/4", 5/16", 3/8", 7/16", 1/2", 9/16", 5/8", 11/16", 3/4", 13/16", 7/8", 15/16", 1", 1-1/16", 1-1/8" and 1-1/4"



KTI41004 4-Piece Jumbo Wrench Set Raised Panel Fractional 2-1/8" to 2-1/2"

- KTI's jumbo wrenches, made of drop forged steel, are chrome-plated and heat-treated to achieve maximum wear
 - A raised panel provides additional strength and durability
 - Jumbo wrenches are designed specifically to meet the needs of the professional who services heavy-duty trucks, tractors and commercial equipment
- Includes sizes 2-1/8", 2-1/4", 2-3/8", 2-1/2". Available individually.

Jumbo Wrenches			
Size	Standard	Size	Standard
1-5/16"	KTI41142	1-7/8"	KTI41160
1-3/8"	KTI41144	2"	KTI41164
1-7/16"	KTI41146	2-1/8"	KTI41168
1-1/2"	KTI41148	2-1/4"	KTI41172
1-5/8"	KTI41152	2-3/8"	KTI41176
1-3/4"	KTI41156	2-1/2"	KTI41180
1-13/16"	KTI41158		



KTI41006 6-Piece Jumbo Wrench Set Raised Panel Fractional 1-3/8" to 2"

- Jumbo wrenches, made of drop forged steel, are chrome-plated and heat-treated to achieve maximum wear
 - A raised panel provides additional strength and durability
 - Jumbo wrenches are designed specifically to meet the needs of the professional who services heavy-duty trucks, tractors and commercial equipment
- Includes sizes 1-3/8", 1-1/2", 1-5/8", 1-3/4", 1-7/8", 2"

HAND TOOLS

Wrenches | Combination Non-Ratcheting

Full Polish Chrome Wrenches					
Fractional			Metric		
	Standard	Stubby		Standard	Stubby
Size	12 pt	12 pt	Size	12 pt	12 pt
1/4"	KTI41308		7mm	KTI41807	
5/16"	KTI41310		8mm	KTI41808	KTI41708
11/32"	KTI41311		9mm	KTI41809	
3/8"	KTI41312	KTI41212	10mm	KTI41810	KTI41710
7/16"	KTI41314	KTI41214	11mm	KTI41811	
1/2"	KTI41316	KTI41216	12mm	KTI41812	KTI41712
9/16"	KTI41318	KTI41218	13mm	KTI41813	KTI41713
5/8"	KTI41320	KTI41220	14mm	KTI41814	KTI41714
11/16"	KTI41322	KTI41222	15mm	KTI41815	KTI41715
3/4"	KTI41324	KTI41224	16mm	KTI41816	
13/16"	KTI41326		17mm	KTI41817	KTI41717
7/8"	KTI41328		18mm	KTI41818	KTI41718
15/16"	KTI41330		19mm	KTI41819	
1"	KTI41332		20mm	KTI41820	
1-1/16"	KTI41334		21mm	KTI41821	
1-1/8"	KTI41336		22mm	KTI41822	
1-3/16"	KTI41338		23mm	KTI41823	
1-1/4"	KTI41340		24mm	KTI41824	
1-5/16"	KTI41342		25mm	KTI41825	
1-3/8"	KTI41344		26mm	KTI41826	
1-7/16"	KTI41346		27mm	KTI41827	
1-1/2"	KTI41348		28mm	KTI41828	
1-9/16"	KTI41350		29mm	KTI41829	
1-5/8"	KTI41352		30mm	KTI41830	
2-1/4"	KTI41372		31mm	KTI41831	
			32mm	KTI41832	
			33mm	KTI41833	
			34mm	KTI41834	
			35mm	KTI41835	
			36mm	KTI41836	

Raised Panel Combination Wrenches				
Fractional			Metric	
Size	6 pt	12 pt	Size	12 pt
1/4"		KTI41108	6mm	KTI41807
5/16"		KTI41110	7mm	KTI41808
3/8"	KTI41412	KTI41112	8mm	KTI41809
7/16"	KTI41414	KTI41114	9mm	KTI41810
1/2"	KTI41416	KTI41116	10mm	KTI41811
9/16"	KTI41418	KTI41118	11mm	KTI41812
5/8"	KTI41420	KTI41120	12mm	KTI41813
11/16"	KTI41422	KTI41122	13mm	KTI41814
3/4"	KTI41424	KTI41124	14mm	KTI41815
13/16"		KTI41126	15mm	KTI41816
7/8"		KTI41128	16mm	KTI41817
15/16"		KTI41130	17mm	KTI41818
1"		KTI41132	18mm	KTI41819
1-1/16"		KTI41134	19mm	KTI41820
1-1/8"		KTI41136	20mm	KTI41821
1-1/4"		KTI41140	21mm	KTI41822
			22mm	KTI41823
			23mm	KTI41824
			24mm	KTI41825
			25mm	KTI41826
			26mm	KTI41827
			27mm	KTI41828
			28mm	KTI41829
			29mm	KTI41830
			30mm	KTI41831
			31mm	KTI41832
			32mm	KTI41833
			33mm	KTI41834
			34mm	KTI41835
			35mm	KTI41836



Wrenches | **Combination Non-Ratcheting**



LIFETIME WARRANTY*

Flare Nut Wrenches Fractional

- Made of heat-treated steel
- Each socket is marked with size for ease of use
- Ideal for gas, brake and air conditioning lines, flare wrenches provide more power and torque where needed
- High-polished, heat-treated chrome vanadium
- Lifetime warranty

Sold separately:

KTI44412 - 3/8" x 7/16"
KTI44420 - 5/8" x 11/16"

KTI44416 - 1/2" x 9/16"



KTI44003

3-Piece Wrench Flare Nut Wrench Set SAE

- Ideal for gas, brake and air conditioning lines, flare wrenches provide more power and torque where needed
- High-polished, heat-treated chrome vanadium steel
- Available individually

Includes double-ended wrenches sized 3/8" x 7/16", 1/2" x 9/16" and 5/8" x 11/16"

KTI44500

3-Piece Flare Nut Wrench Set Metric

Includes double-ended wrenches sized 10mm x 12mm, 13mm x 14mm and 15mm x 17mm. Available individually.

Sold separately:

KTI44910 - 10mm x 12mm
KTI44917 - 15mm x 17mm

KTI44913 - 13mm x 14mm



LIFETIME WARRANTY*



KTI22300

8-Piece Fractional Flare Nut Crowfoot Wrench Set 3/8" Drive

LIFETIME WARRANTY*

- Used for air conditioning, fuel and hydraulic line fittings
- Heat treated, carded with socket rail. Available individually.

Set includes (also available individually):

KTI22312 - 3/8"
KTI22314 - 7/16"
KTI22316 - 1/2"
KTI22318 - 9/16"

KTI22320 - 5/8"
KTI22322 - 11/16"
KTI22324 - 3/4"
KTI22328 - 7/8"



KTI27300

10-Piece Metric Flare Nut Crowfoot Wrench Set 3/8" Drive

- Used for air conditioning, fuel and hydraulic line fittings
- Heat treated, carded with socket rail. Available individually.

Set includes (also available individually):

KTI27310 - 10mm
KTI27311 - 11mm
KTI27312 - 12mm
KTI27313 - 13mm
KTI27314 - 14mm

LIFETIME WARRANTY*

KTI27315 - 15mm
KTI27316 - 16mm
KTI27317 - 17mm
KTI27318 - 18mm
KTI27319 - 19mm



HAND TOOLS

Wrenches | Combination Non-Ratcheting



Adjustable Wrenches

- Manufactured with drop-forged, heat-treated alloy steel for maximum strength and light weight. Chrome plated.

LIFETIME WARRANTY*

Sold separately:

- KTI48004** - 4" jaw capacity: 1/2"
- KTI48006** - 6" jaw capacity: 3/4"
- KTI48008** - 8" jaw capacity: 1"
- KTI48010** - 10" jaw capacity: 1-13/16"
- KTI48012** - 12" jaw capacity: 1-1/2"
- KTI48015** - 15" jaw capacity: 1-7/8"
- KTI48018** - 18" jaw capacity: 2-1/4"
- KTI48008T** - 8" jaw capacity: 1/2"
- KTI48012T** - 12" jaw capacity: 1-1/2"
- KTI48018T** - 18" jaw capacity: 2-1/4"

KTI48012BTW

12" Adjustable Wrench Black Finish

- Chrome vanadium drop forged steel
- Adjustable opening to 1-1/2"
- Length 12"
- Black finish



LIFETIME WARRANTY*

KTI48004T

4" Adjustable Wrench

- 1/2" jaw capacity
- Drop-forged, heat-treated alloy steel for maximum strength and light weight
- Chrome Vanadium steel



LIFETIME WARRANTY*



LIFETIME WARRANTY*

Aluminum Pipe Wrenches

- Weighs 40% less than its cast iron counterpart - a lighter tool is easier to handle and causes less hand fatigue and arm stress
- Features strong hardened jaws, nuts and teeth, and drop forged steel jaws
- A versatile head design provides a flat surface for hammering

Sold separately:

- KTI49112** - 12" jaw capacity: 2-1/4"
- KTI49114** - 14" jaw capacity: 2-5/8"
- KTI49118** - 18" jaw capacity: 3-1/4"
- KTI49124** - 24" jaw capacity: 3-1/2"
- KTI49136** - 36" jaw capacity: 4"



KTI49000

4-Piece Pipe Wrench Set

- Strong, durable and versatile cast iron with drop forged steel jaws
- Perfect for a variety of applications
- Includes 8", 10", 14" and 18" pipe wrenches

Sold separately:

- KTI49008** - 8" jaw capacity: 1-1/2"
- KTI49010** - 10" jaw capacity: 1-7/8"
- KTI49014** - 14" jaw capacity: 1-1/2"
- KTI49018** - 18" jaw capacity: 3"

LIFETIME WARRANTY*



LIFETIME WARRANTY*

Pipe Wrenches

- Constructed from the highest grade cast iron, forged and heat-treated to ensure maximum durability
- Tough red enamel finish. Tool is strong and versatile

Sold separately:

- KTI49012** - 12" jaw capacity: 2-3/8"
- KTI49024** - 24" jaw capacity: 1-1/2"
- KTI49036** - 36" jaw capacity: 3-1/2"



KTI49309

9" Auto Wrench (Monkey Wrench)

- Auto wrench (monkey wrench)
- 9" Length
- Adjustable opening to 2-1/2"
- Black Oxide

LIFETIME WARRANTY*



KTI49315

15" Auto Wrench (Monkey Wrench)

- 15" Length
- Adjustable opening to 3-1/4"
- Black Oxide

LIFETIME WARRANTY*





PROFESSIONAL TOOLS & EQUIPMENT



HAND TOOLS

Wrenches | Combination Ratcheting



KTI45400 7-Piece Ratcheting Wrench Set Fractional 5/16" to 3/4"



- Ratcheting box end needs as little as 5 degrees to move fastener
 - Designed to reduce fastener rounding
 - Wrenches feature a sleek head design for tight access points and all metal construction for durability and strength
- Includes sizes 5/16, 3/8", 7/16", 1/2", 9/16", 5/8" and 3/4"

KTI45500 7-Piece Ratcheting Wrench Set Metric 8mm - 18mm



Includes sizes 8mm, 10mm, 12mm, 13mm, 14mm, 15mm and 18mm.

KTI45600 16-Piece Reversible Ratcheting Wrench Set Metric 8mm - 24mm



- Enjoy the speed of a ratchet with the accessibility of a wrench in this version with a reversing mechanism
- Ratcheting box end needs as little as 5 degrees to move fastener
- Reduce fastener rounding
- Wrenches feature a sleek head design for tight access points and all metal construction for durability and strength

Includes sizes 8mm, 9mm, 10mm, 11mm, 12mm, 13mm, 14mm, 15mm, 16mm, 17mm, 18mm, 19mm, 20mm, 21mm, 22mm, 24mm,



KTI45601 12-Piece Reversible Ratcheting Metric Wrench Set

Includes: 8mm - 19mm



KTI45602 7-Piece Reversible Ratcheting Metric Wrench Set

Includes: 8mm - 18mm



Ratcheting Wrenches - Combination				
	Fractional		Metric	
	Standard	Stubby		Standard
Size	12 pt	12 pt	Size	12 pt
5/16"	KTI45410		8mm	KTI45508
3/8"	KTI45412		10mm	KTI45510
7/16"	KTI45414		12mm	KTI45512
1/2"	KTI45416		13mm	KTI45513
9/16"	KTI45418	KTI45318	14mm	KTI45514
5/8"	KTI45420		15mm	KTI45515
3/4"	KTI45424		18mm	KTI45518

Wrenches | Combination Ratcheting



KTI45900 13-Piece Reversible Ratcheting Wrench Set Fractional 1/4" to 1"

- Enjoy the speed of a ratchet with the accessibility of a wrench in this version with a reversing mechanism
 - Ratcheting box end needs as little as 5 degrees to move fastener
 - Reduce fastener rounding
 - Wrenches feature a sleek head design for tight access points and all metal construction for durability and strength
- Includes sizes 1/4", 5/16, 3/8", 7/16", 1/2", 9/16", 5/8", 11/16", 3/4", 13/16", 7/8", 15/16" and 1".



KTI45901 9 Piece Reversible Ratcheting SAE Wrench Set

- Ratcheting box end needs as little as 5° to move fastener
 - Reduce fastener rounding
 - Wrenches feature a sleek head design for tight access points and all metal construction for durability and strength
- Includes: 1/4" - 3/4"



KTI45902 7 Piece Reversible Ratcheting SAE Wrench Set

- All metal construction for durability and strength
- Ratcheting box end needs as little as 5° to move fastener
- Designed to reduce fastener rounding
- Sleek head design for tight access points



Set includes: 5/16", 3/8", 7/16", 1/2", 9/16", 5/8" and 3/4"



Ratcheting Wrenches - Reversible			
Fractional		Metric	
Standard		Standard	
Size	12 pt	Size	12 pt
1/4"	KTI45908	8mm	KTI45608
5/16"	KTI45910	9mm	KTI45609
3/8"	KTI45912	10mm	KTI45610
7/16"	KTI45914	11mm	KTI45611
1/2"	KTI45916	12mm	KTI45612
9/16"	KTI45918	13mm	KTI45613
5/8"	KTI45920	14mm	KTI45614
11/16"	KTI45922	15mm	KTI45615
3/4"	KTI45924	16mm	KTI45616
13/16"	KTI45926	17mm	KTI45617
7/8"	KTI45928	18mm	KTI45618
15/16"	KTI45930	19mm	KTI45619
1"	KTI45932	20mm	KTI45620
		21mm	KTI45621
		22mm	KTI45622
		24mm	KTI45624



Ratcheting Box Wrenches Fractional

- Combines the ratcheting action of a socket with the low profile of a box wrench, making those hard to reach jobs quick and easy



Sold separately:

KTI45208 - 1/4" x 5/16"

KTI45212 - 3/8" x 7/16"

KTI45216 - 1/2" x 9/16"

KTI45220 - 5/8" x 3/4"

HAND TOOLS

Wrenches | Combination Ratcheting



KTI43500

5-Piece Metric

X-Long Double Box Ratcheting

Flexible Reversible Spline Wrench Set

- These extra-long, flexible and reversible double box ratcheting wrenches are forged of chrome-vanadium steel and heat-treated for durability
 - Wrenches in this 5-piece set feature a 72-tooth design with a high polish finish and are nearly 40% longer
 - Ratcheting box end needs as little as 5 degrees to move fastener
 - Sleek head design and slim dimensions further ease of working in confined areas
- Includes the following metric sizes: 8mm x 10mm, 12mm x 13mm, 14mm x 15mm, 16mm x 18mm and 17mm x 19mm. Packaged in a blow-molded case.



KTI43100

4-Piece Fractional

X-Long Double Box Ratcheting

Flexible Reversible Spline Wrench Set

- These extra-long, flexible and reversible double box ratcheting wrenches are forged of chrome vanadium steel and heat-treated for durability
 - Wrenches in this 4-piece set feature a 72-tooth design with a high-polish finish and are nearly 40% longer
 - Ratcheting box end needs as little as 5 degrees to move fastener
 - Sleek head design and slim dimensions further ease of working in confined areas
 - Packaged in a blow-molded case
- Includes sizes: 5/16" x 3/8", 7/16" x 1/2", 9/16" x 5/8" and 11/16" x 3/4"



Ratcheting Wrenches - Double Box	
Size	Extra Long Flex
5/16"	KTI43112 - (5/16" x 3/8")
7/16"	KTI43116 - (7/16" x 1/2")
9/16"	KTI43120 - (9/16" x 5/8")
11/16"	KTI43124 - (11/16" x 3/4")



X-Long Double Box

Ratcheting / Flexible / Reversible Spline

Metric Wrenches

- This extra-long, flexible and reversible double box ratcheting wrench is forged of chrome vanadium steel and heat-treated for durability
- It features a 72-tooth design with a high-polish finish and is nearly 40% longer
- Ratcheting box end needs as little as 5 degrees to move fastener
- Sleek head design and slim dimensions further ease of working in confined areas

Sold separately:

KTI43510 - 8mm x 10mm

KTI43513 - 12mm x 13mm

KTI43515 - 14mm x 15mm

KTI43518 - 16mm x 18mm

KTI43519 - 17mm x 19mm



Ratcheting-style Torque Wrenches

- Ratcheting style torque wrench “clicks” when proper torque is achieved.
- Accuracy: $\pm 4\%$. Works in clockwise direction
- Packaged in blow-molded case

KTI72117	30-150 in./lbs.	1/4" drive	7-3/4" length
KTI72100	20-200 in./lbs.	3/8" drive	11" length
KTI72101	10-150 ft./lbs.	1/2" drive	18" length
KTI72102	25-250 ft./lbs.	1/2" drive	25" length
KTI72175	100-600 ft./lbs.	3/4" drive	42" length

Warranty information:
90-day limited warranty. Repairable item.
Half-price replacement option after 90-days.

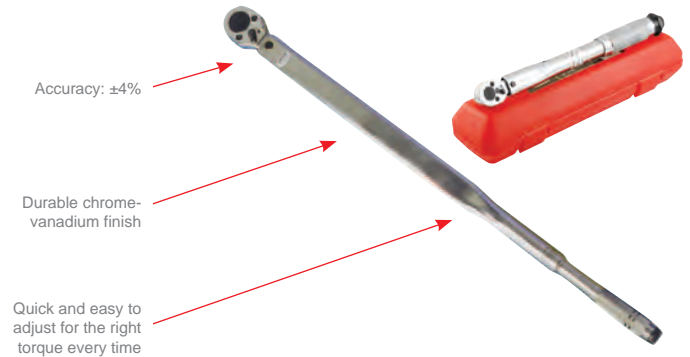

Micrometer-style Adjustable Torque Wrenches - U.S.-made



- Dual scale, calibrated dual direction
- Positive lock with spring loaded pull down lock ring
- Fast, accurate and easy to set with ergonomic comfort-grip
- Easy-to-read laser marked scales
- Individually serialized with matching certificate of calibration traceable to N.I.S.T.
- Most feature quick release buttons which provide good socket retention as well as easy socket removal (except KTI72176A)
- Each comes in a blow molded case
- Accuracy: $\pm 4\%$ clockwise $\pm 6\%$ CCW of indicated value, CW, from 20% to 100% of full scale
- Meets or exceeds ASME B107.14M-1994, ISO 6789 Standards
- Covered by a 1-Year limited warranty

KTI72118A	20-150 in./lbs.	1/4" drive	10" length
KTI72120A	30-250 in./lbs.	3/8" drive	11.2" length
KTI72121A	10-100 ft./lbs.	3/8" drive	16" length
KTI72125A	20-150 ft./lbs.	1/2" drive	19" length
KTI72126A	30-250 ft./lbs.	1/2" drive	24.5" length
KTI72176A	100-600 ft./lbs.	3/4" drive	41" length



Micrometer-style Adjustable Torque Wrenches

- Achieve the proper torque with KTI's click-style torque wrenches
- Torque wrenches are extremely accurate and easy-to-use: Simply adjust the torque specification on the wrench by releasing the red knob and turning the handle of the torque wrench while holding the shaft of the torque wrench
- Torque wrenches feature a ball detent socket retainer with push-button release for quick socket changes
- Works in clockwise and counter-clockwise directions
- Accuracy: $\pm 4\sim 6\%$
- Packaged in a blow-molded case

KTI72140	50-250 in./lbs.	3/8" drive	8-3/4" length
KTI72143	10-100 ft./lbs.	3/8" drive	16-1/4" length
KTI72141	30-150 ft./lbs.	1/2" drive	18-3/4" length
KTI72142	30-250 ft./lbs.	1/2" drive	21-1/2" length
KTI72145	100-600 ft./lbs.	3/4" drive	39" length

Warranty information:
90-day limited warranty. Repairable item.
Half-price replacement option after 90-days.

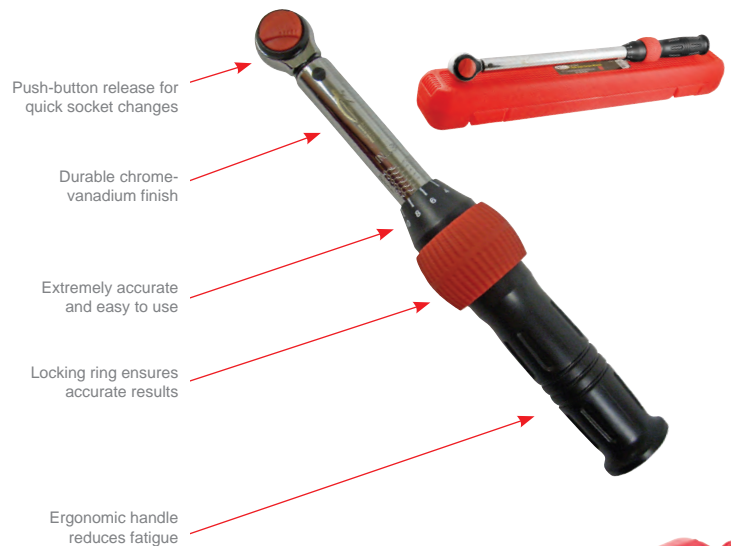

HAND TOOLS



KT172149 Torque Wrench 3/8" Drive 150-750 in./lbs

- 3/8" drive ratcheting torque wrench
- 150 - 750 in./lbs. in 5 lb increments
- Calibration certificate included
- Comes in a black blow-mold case
- 90-day limited warranty



Digital Torque Wrenches

- Eliminates the possibility of human error with a series of lights and alarms that immediately alert the user to torque readings that are "over or under" entered values
- Easy to use, exceedingly accurate (plus/minus 1 percent CW, plus/minus 2 % CCW)
- High contrast, backlit LCD screen display, users press only four buttons to operate the tool: power on/off; unit of measurement (ft./lbs., in./lbs., N-m); torque target up; and torque target down.
- Technicians can quickly switch among three types of measurement, eliminating the need to have three separate tools
- The wrench boasts a non-slip grip, a rugged, durable housing, a 36-tooth gear and a lever-type ratchet to ease directional switching
- Estimated battery life: 110 hours
- Blow-molded case

KT172130	10-100 ft./lbs.	3/8" drive	16-1/4" length
KT172133	14.8-73.8 ft./lbs.	3/8" drive	15" length
KT172132	20-250 ft./lbs.	1/2" drive	25" length
KT172134	29.5-147.5 ft./lbs.	1/2" drive	19-1/16" length
KT172135	25-250 ft./lbs.	1/2" drive	22-1/4" length

Warranty information:

1-year warranty. Repair or replace at discretion of repair center.

KT172138 Digital Torque Adaptor 1/2" Drive

- Use with 1/2" drive ratchet
- Static torque measurement
- Three standard functions: torque setting, measurement setting and mode setting
- Operates in clockwise and counter-clockwise directions
- Torque range is 29.5 - 147.5 ft-lbs
- Digital torque adaptor turns a regular ratchet into a digital ratchet
- Tool length: 3". Comes in a black blow-mold storage case



Warranty information: 1-year warranty.



KT172190 Torque Multiplier

- Converts low torque into high torque, reducing amount of strength required to loosen or tighten when using only a torque wrench
- Input Square: 3/4" drive and Output Square: 1" drive
- Input: 730 ft-lbs. (1000 NM) and Output: 2200 ft-lbs. (3000 NM)
- Increases range of torque 3:1
- Tool length: 19.500", body length 6.500", reaction bar length: 15.625", head width: 3.750", female depth: .750", male depth: 1.125", head depth from female to male: 4.500"
- Comes in a convenient plastic, blow-molded carrying/storage case 1-year warranty.

KT149400 Universal Drum Bung Wrench, Bronze Non-Sparking

- Universal drum bung wrench
- Manufactured of bronze alloy
- Non-sparking for flammable materials
- Fits all types of industrial drum nut plugs and bungs in metal and plastic
- Corrosion resistant

**LIFETIME
WARRANTY***



KT149405 Universal Drum Plug Bung Wrench, Ductile Iron

- Universal drum plug bung wrench
- Manufactured of ductile iron
- One-piece construction for long-lasting and durability
- Use to open and close all steel and plastic hex-head and round-head bung nut plugs
- Corrosion resistant

**LIFETIME
WARRANTY***





LIFETIME WARRANTY*

KTI71771
13 oz. Fiberglass Claw Hammer
 • Fiberglass handle and rubber grip

Solid Brass Hammers

- Non-sparking brass hammer prevents damage to delicate parts

Sold separately:

KTI71782 - 27oz., 1-1/16" head diameter

KTI71783 - 48oz., 1-1/4" head diameter



LIFETIME WARRANTY*



LIFETIME WARRANTY*

Brass Hammers with Hickory Handles

- Non-sparking brass hammer prevents damage to delicate parts

Sold separately:

KTI71714 - 16oz., 1-1/4" head diameter

KTI71715 - 24oz., 1-1/4" head diameter

KTI71733 - 32oz., 1-1/2" head diameter



KTI71700
Impact Driver with 4-Piece Bit Set
3/8" Drive

- A 3/8" driver with four (4) 5/16" hex bits (small slotted, large slotted, #2 Phillips and #3 Phillips) for loosening rusted screws, nuts and bolts
- Packaged in a metal box

Bits also available individually:

KTI18801 - Small Slotted Bit

KTI18802 - Large Slotted Bit

KTI18702 - #2 Phillips Bit

KTI18703 - #3 Phillips Bit



LIFETIME WARRANTY*



KTI71751
Rubber Mallet 24oz.
 • Non-marking rubber mallet

LIFETIME WARRANTY*



Ball Pein Hammers

- Hammer features drop forged, heat-treated steel head and fiberglass handle for strength and reliability
- Tool boasts contoured, nonslip rubber grip for user comfort

Sold separately:

KTI71708 - 8oz.

KTI71725 - 24oz.

KTI71716 - 16oz.

KTI71732 - 32oz.

LIFETIME WARRANTY*



LIFETIME WARRANTY*

KTI71704
4 oz Ball Pein Hammer
 • Fiberglass handle and rubber grip



KTI71724
4lb. Cross Pein Hammer
 • Fiberglass handle and rubber grip. Overall length: 15-1/4"

LIFETIME WARRANTY*



HEAVYWEIGHT QUALITY. KNOCKOUT PRICE.

Serving the Automotive Industry Since 1984

Wixom, MI 48393

www.ktoolinternational.com

KT123308

Bit Holder 1/2 drive

- 1/4" Hex Male to 1/2" Male Square Drive



KT118000

12 Piece Bit Set

- 12 Piece Bit set includes: Slotted 1/8", 5/32", 3/16", 1/4"; Phillips #0, #1, #2, #3, Torx T-10, T-15, T-20, T-25
- All packaged in convenient organizer case



KT118007

Bit holder, Interior Clip

1/4" Drive x 1/4" Hex Female

- Chrome plating finish



LIFETIME WARRANTY*

KT118013

Bit Holder, Exterior Clip

3/8" Drive x 1/4" Hex Female

- Chrome plating finish



LIFETIME WARRANTY*

KT118014

Bit Holder, Exterior Clip

3/8" Drive x 5/16" Hex Female

- Chrome plating finish



LIFETIME WARRANTY*

KT122914

3/8" Drive Hex Bit

9/64" x 1" Length

- Hex bit socket made of chrome vanadium steel
- Heat treated for durability



LIFETIME WARRANTY*

KT118992

#2 Phillips Power Bit, 2" Long 1/4" Shank

LIFETIME WARRANTY*

Groove Joint Pliers

- Can be adjusted to grip or turn objects
- Ideal for grasping nuts or pipe
- Manufactured from chrome vanadium steel with chrome finish
- Ergonomic vinyl handle for user comfort
- Available in three sizes



Sold separately:

KT154006 - 6"

KT154010 - 10"

KT154012 - 12"

LIFETIME WARRANTY*

KT153006T

Slip Joint Pliers 6" Long



LIFETIME WARRANTY*

Slip Joint Pliers

- Designed for gripping and turning round objects
- Manufactured from chrome vanadium steel with chrome finish
- Ergonomic vinyl handle for user comfort
- Available in three sizes



Sold separately:

KT153004 - 4"

KT153006 - 6"

KT153008 - 8"

LIFETIME WARRANTY*

KT151103

3-Piece

11" Needle Nose Plier Set

- These extra long needle nose pliers reach into even the tightest places
- Pliers manufactured with heat-treated chrome vanadium steel for long wear
- Tools feature soft comfort grip handles. Packaged in handy storage pouch
- Set includes 15° offset, 45° bent nose and 90° bent nose



Set includes (also available individually):

KT151111 - 90° bent nose

KT151211 - 45° offset

KT151311 - 15° offset

LIFETIME WARRANTY*

HAND TOOLS

Needle Nose Pliers

- Needle nose pliers reach into even the tightest places
- Tool features side cutter and non-slip vinyl grip
- Manufactured from heat-treated chrome vanadium for durability
- Each sold separately

Sold separately:

- KTI51006** - 6"
- KTI51206** - 6" bent end
- KTI51007** - 7"
- KTI51008** - 8"

LIFETIME WARRANTY*



KTI51006T Needle Nose Plier 6", with Side Cutter, Vinyl Grips

LIFETIME WARRANTY*

KTI58705 Locking Plier Curved Jaw 5"

- Curved-jaw pliers apply maximum torque for any application
- Manufactured from high-grade heat-treated alloy steel for strength and durability
- Hardened teeth provide superior grip at any angle
- Adjusting screw tightens to adjust pressure for a secure, firm grip every time
- Quick-release trigger. Overall length: 5". Meets or exceeds ANSI standards.



LIFETIME WARRANTY*

KTI58710 Locking Plier Curved Jaw 10"

- Curved-jaw pliers apply maximum torque for any application
- Manufactured from high-grade heat-treated alloy steel for strength and durability
- Hardened teeth provide superior grip at any angle
- Adjusting screw tightens to adjust pressure for a secure, firm grip every time
- Quick-release trigger. Overall length: 10". Meets or exceeds ANSI standards.

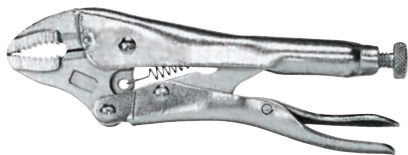

LIFETIME WARRANTY*

KTI58707 Locking Plier Curved Jaw 7"

- Curved-jaw pliers apply maximum torque for any application
- Manufactured from high-grade heat-treated alloy steel for strength and durability
- Hardened teeth provide superior grip at any angle
- Adjusting screw tightens to adjust pressure for a secure, firm grip every time
- Quick-release trigger. Overall length: 7". Meets or exceeds ANSI standards.



LIFETIME WARRANTY*

LIFETIME WARRANTY*

KTI58717 Locking Plier Straight Jaw 7"

- Straight-jaw pliers apply maximum torque for flat, square or hex applications
- Manufactured from high-grade heat-treated alloy steel for strength and durability
- Hardened teeth provide superior grip at any angle
- Adjusting screw tightens to adjust pressure for a secure, firm grip every time
- Quick-release trigger. Overall length: 7". Meets or exceeds ANSI standards.



KTI58809 Locking Welding Clamp Plier 9"

- Locking welding clamp features U-shaped jaws for improved visibility and less obstruction to work area
- Perfect for welding applications or securing awkward-shaped work pieces
- Manufactured from high-grade heat-treated alloy steel for strength and durability
- Superior grip to hold work pieces in proper alignment
- Adjusting screw tightens to adjust pressure for a secure, firm grip every time
- Quick-release trigger. Overall length: 9". Meets or exceeds ANSI standards.



LIFETIME WARRANTY*

KTI58811 Locking C-Clamp Plier 11"

- Locking C-clamp plier features wide-opening jaws to accommodate a variety of shapes and sizes for any application
- Manufactured from high-grade heat-treated alloy steel for strength and durability
- Adjusting screw tightens to adjust pressure for a secure, firm grip every time
- Quick-release trigger. Overall length: 11". Meets or exceeds ANSI standards.



LIFETIME WARRANTY*

KTI54055 Exhaust Grommet Pliers

- Heavy duty auto tool for removal of exhaust components from rubber-style hangers
- Self-locating forcing pin
- Cushioned slip-resistant handles
- 25° offset for easy access



LIFETIME WARRANTY*

KTI55112

12-Piece

Reversible Snap Ring Plier Set

- Set includes the four most popular tip sizes in straight, 45 and 90° angle configurations
- These versatile, heavy duty pliers are designed for the removal and installation of either internal or external snap rings on a wide range of applications
- Packaged in blow-molded case. Available individually.

Set includes (also available individually):

KTI55120 - straight tip .038

KTI55122 - straight tip .070

KTI55121 - straight tip .047

KTI55123 - straight tip .090

KTI55130 - 45° bent tip .038

KTI55132 - 45° bent tip .070

KTI55131 - 45° bent tip .047

KTI55133 - 45° bent tip .090

KTI55140 - 90° bent tip .038

KTI55142 - 90° bent tip .070

KTI55141 - 90° bent tip .047

KTI55143 - 90° bent tip .090



LIFETIME WARRANTY*

KTI55001

5-Piece

Reversible Snap Ring Plier Set

- Set includes: short straight small tip (2 pieces); long straight large tip; short 90 degree small tip; and long 90° large tip
- These versatile, heavy duty pliers are designed for the removal and installation of either internal or external snap rings on a wide range of applications
- Packaged in blow-molded case. Available individually.

Set includes (also available individually):

KTI55012 - short, straight small tip (2 pc.)

KTI55912 - short 90° small tip

KTI55034 - long, straight large tip

KTI55934 - long 90° large tip



LIFETIME WARRANTY*

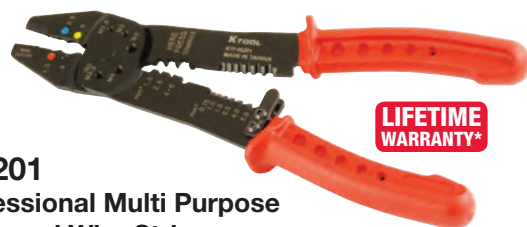

LIFETIME WARRANTY*

KTI56201

9" Professional Multi Purpose Crimper and Wire Stripper

- 9" Length
- Wire cutter, bolt cutter, and wire stripper in one
- Crimps insulated and open barrel terminals



KTI56207

9.75" Professional 8-in-1 Quick and Easy Wire Stripper

- 9.75" Length
- Wire cutter, bolt cutter, wire stripper, and bending wire
- Crimps insulated, non-insulated, and pin terminals

LIFETIME WARRANTY*



KTI56208

Self Adjusting Wire Stripper

- Automatically adjusts to the diameter of the wire
- Strips, cuts and crimps wire for solderless terminals
- Capacity range: 22 to 10 awg
- Curved back handle design with comfort grip
- Tool length: 10"

LIFETIME WARRANTY*



KTI56202

8.5" Professional Multi Purpose Crimper and Wire Stripper

- 8.5" Length
- 3.2mm thickness
- Wire cutter, bolt cutter, and wire stripper in one
- Crimps open barrel terminals

LIFETIME WARRANTY*



HAND TOOLS



KTI56205

8.7" Ratcheting Terminal Crimper

- For insulated terminal
- Carbon steel head
- Polypropylene and thermoplastic rubber handle
- Tool capacity: Red 22-18 AWG, Blue 16-14 AWG, Yellow 12-10 AWG
- Adjusted by screwdriver

LIFETIME WARRANTY*



KTI56203

Professional Crimping Tool - 0.5/1.5/2.5/4.0/6.0 MM2

- Crimps non-insulated terminals
- Easy to grip handles

LIFETIME WARRANTY*



KTI56204

Professional Multipurpose Crimping and Wire Stripper - 1.5/2.5/6.0/10/16 MM2

- Crimps non-insulated terminals
- Easy to grip handles

LIFETIME WARRANTY*

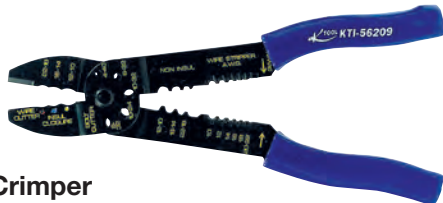

KTI56209

Wire Stripper / Crimper

- Can be used as wire stripper, machine screw cutter, wire cutter, insulated crimper or solderless terminal crimper.

LIFETIME WARRANTY*



KTI52009

Heavy Duty Cable Cutters

- Heavy duty
- For use in cutting copper and aluminum
- 9-1/4" Length
- Jaws open to approximately 2"
- Do not use on steel wire or ACSR cable

LIFETIME WARRANTY*

Diagonal Cutters

- Manufactured from chrome vanadium steel
- Ergonomic handle for user comfort
- Available in three sizes

Sold separately:

KTI52006 - 6"

KTI52006T - 6"

KTI52007 - 7"

KTI52007T - 7"

KTI52107 - 7" heavy-duty

LIFETIME WARRANTY*



KTI54050

Cannon Plug Pliers

- Cannon plug pliers fit A-N electrical connectors from 3/4" to 2-1/2"
- Slip-joint design with 4 adjustment positions and dipping handle
- Soft, non-marring white nylon jaw inserts with serrations
- Jaw width: 3/8" and open capacity: 3/4" to approximately 2-1/2"
- Plier length: 10"

LIFETIME WARRANTY*



KTI72380

8" Straight Cut Tin Snips

- One piece drop forged construction of high carbon steel
- Cushion handle with smooth, comfortable bows for ease in use and safety
- Designed for cutting straight and wide curves to the left or right
- Cuts up to .61mm cold rolled steel or .41mm stainless steel
- Cutting blades open to approximately 4" wide
- Induction hardened cutting edges 54-58 HRC

LIFETIME WARRANTY*



Clipper Side Cut



KTI57324

24" Clipper Cut Bolt Cutters

- Cutting head is manufactured from chrome-vanadium steel
- Can be used for cutting chains, padlocks, bolts and wire mesh
- The clipper-cut style blades are flush against one face for cutting against flat surfaces

LIFETIME WARRANTY*



LIFETIME WARRANTY*

KTI59000

Auto Return Wire Twister Pliers 9"

- Includes an automatic spring return for quick and efficient operation
- Overall length of 8-3/4" and wire capacity of .041"
- Reversible action for left and right twists.
- Diagonal nose to reach tight areas on your aircraft or other machinery



LIFETIME WARRANTY*

KTI72644

Steel Folding Rule 3' Length

- Stainless steel folding rule
- Multiple folding joints every 6"
- Width: 19/32" (15mm) • Thickness: 0.6mm
- Etched with SAE measurements on one side

Tape Measure

- SAE and metric markings
- Blade material is spring-tempered steel
- Top lock for blade with automatic blade return
- Removable spring-tempered steel belt clip
- Lifetime warranty

- KTI72606 - 6' x 1/2"
- KTI72608 - 8' x 1/2"
- KTI72610 - 10' x 3/4"
- KTI72612 - 12' x 1/2"
- KTI72616 - 16' x 3/4"
- KTI72625 - 25' x 1"

LIFETIME WARRANTY*





TOOL STORAGE



1.800.762.6002 | www.ktoolinternational.com

Service Carts



KTI75146

4 Drawer Locking Service Cart

- 500 lb. load capacity
- Ball bearing drawer slides. Drawer liners for all drawers and trays
- 5 " Heavy-duty casters
- Side impact bumpers
- Gas shocks for lid
- Cart dimensions: 148 lbs, 35.2" length, 20.6" width, 40.3" height.
Top drawer depth (2) 3", Middle drawer depth 3", Bottom drawer depth 6"
- 1 Year Warranty on material and workmanship



KTI75105

One-Drawer Steel Service Tool Cart with 2 Lined Shelves

- Durable construction for rugged shop environments
- Sturdy, one-piece drawer handle. Cart provides ample storage.
- Large, fully-lined top and bottom storage trays to organize tools, shop accessories and parts for greater accessibility
- Fully-lined drawer with lock to securely store tools when not in use
- Four casters allow steady, quick movement; two casters feature easy-to-operate locking mechanism
- Warranty information: 1-year warranty



TOOL STORAGE



Two gas struts in lid for ease in opening or closing. Hinged lid opens completely for greater access to tools. Piano-style hinge for added durability.

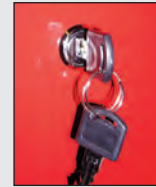

Top locking tray keeps tools safe and secure when not in use. Drawers will not function when top storage tray is closed.

Top drawer dimensions (each)
11-1/2" W x 16-7/8" D x 4-1/2" H

Middle drawer dimensions
24-1/2" W x 16-7/8" D x 2-1/2" H

Bottom drawer dimensions
24-1/2" W x 16-7/8" D x 4-1/2" H

4-drawer overall dimensions
39" W x 19-1/2" D x 41-1/4" H

Heavy-duty 5" x 2" casters. Two casters feature easy-to-operate locking mechanism to keep cart from rolling.

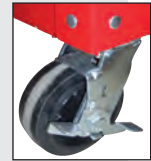

4-drawer Utility Carts

Part numbers:

- KTI75140** - Red
- KTI75141** - Blue
- KTI75142** - Teal
- KTI75143** - Yellow
- KTI75145** - Black

Warranty info: 1-year warranty.



Features 22-slot screwdriver and/or prybar holder allowing handles to be stowed in top locking tray.



Store large-handle pry bars (up to 10") that won't fit in the top storage tray. Piano-style hinge folds down completely for easy access to pry bars, screwdrivers and other tools. Includes 22 slots and measures 18½" x 12" x 4".

Features side storage tray. Perfect for storage of tall items including aerosol cans.



Large drawers and trays to hold and organize tools. All drawers and trays include liners made of non-toxic EVA.



Drawers feature all steel ball bearing slides for smooth, quiet operation.



Keep drawers closed securely until needed. Easy, one-hand operation. Drawer locks can only be operated when top lid is open.

Large bottom storage tray. Extra storage for oversized items. Great for shop towels, gallon-size containers and other large shop accessories.



Service Carts | Parts & Accessories

KT172451 Magnetic Tool Hanger for Air Impact - 20 lb. Capacity

- Effortlessly holds most pistol-type impact wrenches.
- Screw-hole design allow for easy mounting to nonferrous surface.
- Magnetic mount supports up to 20 lbs.

LIFETIME WARRANTY*



KT172465 Magnetic Tool Holder Multipurpose 15 lb. Capacity

- Holds a variety of screwdrivers, pliers, sockets, wrenches, hammers and more
- Firmly attaches to metal surface
- Extends up to 20" wide
- Each socket seat encases a powerful magnet
- Special hooks hold wrenches, keys and other hard to store items
- Permanently mount using screw holes or built in magnets support up to 15 lbs
- Stores up to 71 tools

LIFETIME WARRANTY*



KT172450 Magnetic Tool Hanger 11 lb. Capacity

- Holds heavy and irregularly shaped tools, such as hammers, mallets and wrenches.
- Ideal for storing cords, shovels, and more.
- Screw-hole design allow for easy mounting to nonferrous surfaces.
- Magnetic mount supports up to 11 lbs.

LIFETIME WARRANTY*



KT172460 Magnetic Tool Box 33 lb. Capacity

- Powder-coating finish protects holder even in rugged, professional environments.
- Chamfer design holds various tools, such as cans, brushes and tape.
- Organize workshops, garages and manufacturing sites.
- Screw-hole design allows for easy mounting to nonferrous surfaces.
 - Portable holder goes from job to job.
- Holds up to 33 lbs.

LIFETIME WARRANTY*



TOOL STORAGE

Trays | Socket Rails & Socket Holders



KTI72470

3 Piece SAE Socket Holder Set - Red

- 1/4", 3/8" and 1/2" drive socket trays
- Impact resistant ABS plastic

Set Includes:

KTI72471 - 1/4" Drive SAE - Holds 26 sockets (13 short & 13 deep)
Socket sizes: 1/8" - 5/8" each

KTI72472 - 3/8" Drive SAE - Holds 26 sockets (13 short & 13 deep)
Socket sizes: 1/4" - 1" each

KTI72473 - 1/2" Drive SAE - Holds 28 sockets (14 short & 14 deep)
Socket sizes: 3/8" - 1-1/4" each



KTI72475

3 Piece Metric Socket Holder Set, Gray

- 1/4", 3/8" and 1/2" drive socket trays
- Impact resistant ABS plastic

Set Includes:

KTI72476 - 1/4" Drive Metric - Holds 28 sockets (14 short & 14 deep)
Socket sizes: 4-15mm each

KTI72477 - 3/8" Drive Metric - Holds 30 sockets (15 short & 15 deep)
Socket sizes: 6 - 20mm each

KTI72478 - 1/2" Drive Metric - Holds 34 sockets (17 short & 17 deep)
Socket sizes: 10 - 27mm each

MAG-CLIP

By K-Tool International®

Original Mag-Clip Strip

Magnetic socket holders hold sockets tight without magnetizing them. Hangs or mounts on any smooth metal surface.

Other Features:

- Shallow or deep socket
- Standard or metric sockets
- Holds socket tight and secure on any smooth metal surface
- Will not magnetize sockets
- Magnets retain strength permanently
- Grease, oil and chemical resistant
- Tough polymer base
- Rust resistant

MCP72401 - 1/4" drive

MCP72402 - 3/8" drive

MCP72403 - 1/2" drive

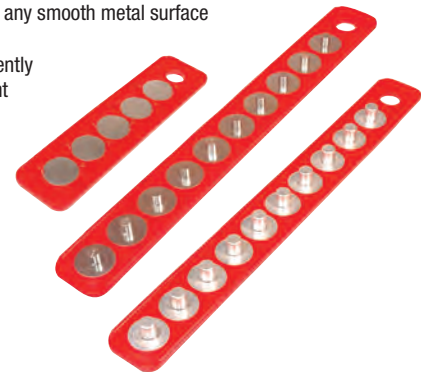

LIFETIME WARRANTY*

MAG-CLIP

By K-Tool International®

Interchangeable Mag-Clip Strip

Magnetic socket holders hold sockets tight without magnetizing them. Use with additional Power Pegs (sold separately) in any combination of 3 drive sizes to customize your workspace.

Other Features:

- Shallow or deep socket
- Standard or metric sockets
- Holds socket tight and secure on any smooth metal surface
- Will not magnetize sockets
- Magnets retain strength permanently
- Grease, oil and chemical resistant
- Tough polymer base
- Rust resistant

Includes 10 interchangeable Power Pegs.

MCP72400 - 1/4" drive

MCP72404 - 3/8" drive

MCP72405 - 1/2" drive

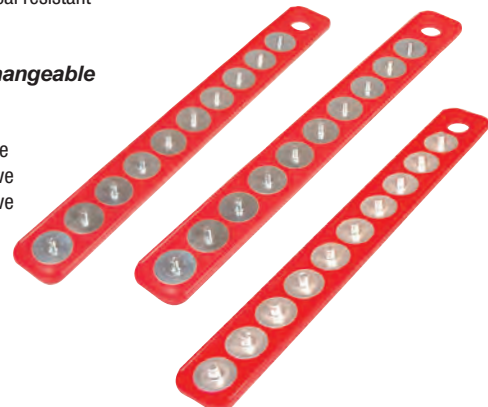

LIFETIME WARRANTY*

MAG-CLIP

By K-Tool International®



Socket Caddy

This organizer allows users to customize the storage and organization of some of the messiest areas of the average tool box, such as the socket drawer. The base of this product is made out of a high impact plastic magnetic grid. Use with additional Power Pegs (sold separately) in any combination of 3 drive sizes to customize your workspace.

Other Features:

- Shallow or deep sockets
- Standard or metric sockets
- Will not magnetize sockets
- Magnets retain strength permanently
- Grease, oil and chemical resistant
- Tough polymer base
- Rust resistant

Includes 28 interchangeable Power Pegs.

- MCP72421** - 1/4" drive
- MCP72422** - 3/8" drive
- MCP72423** - 1/2" drive



MCP72460 Universal Mag-Clip

Use the Universal Mag-Clip Strip to hold wrenches, screwdrivers, pliers and other hand tools to keep them at your fingertips.

Other Features:

- Mounts on any smooth metal surface
- Holds tools tight and secure
- Reverse polarity magnetic power
- Magnets retain strength permanently
- Grease, oil and chemical resistant
- Tough polymer base
- Rust resistant

LIFETIME WARRANTY*

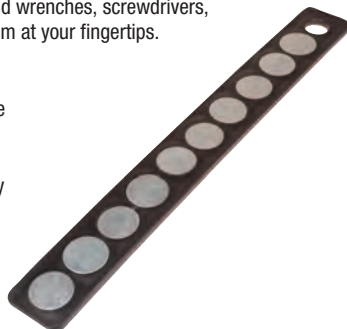

Power Pegs

- Interchangeable steel posts available in 1/4", 3/8" and 1/2" drive sizes
- Use Power Pegs with MagKanic Mat, Power Mat, Socket Caddy or Interchangeable Mag-Clip Strip for the ultimate storage system
- Available in packs of 10

- MCP72441** - 1/4" drive
- MCP72442** - 3/8" drive
- MCP72443** - 1/2" drive



LIFETIME WARRANTY*

Magnetic Mat

- Magnetic, convertible and interchangeable means for storing and organizing sockets
- Organize sockets or simply flip the mat over to the rubber side and store a variety of other tools in a vertical position
- High powered magnets are imbedded in a flexible, high impact poly-pro body
- May be used with Power Pegs (sold separately) in any combination of 3 drive sizes (1/4", 3/8" or 1/2") to customize your workspace

- MCP72424** - 2-panel MagKanic Mat
- MCP72425** - 3-panel Power Mat
- MCP72426** - 3-panel Power Mat with 84 assorted power pegs

Mag Mount

- Magnetic tool storage and/or mounting system for use with pegboard
- The Mag Mount will hold tools securely without the use of hooks or bars
- This design will work with 1/8" and 1/4" pegboard and features "super duty" magnetic power
- Includes screws for 1/8" and 1/4" pegboard

- MCP72453** - 3 pack
- MCP72455** - 5 pack





LIGHTING



1.800.762.6002 | www.ktoolinternational.com

Hand Held

KTI73389 **Slimline 6 LED** **Rechargeable Inspection Light**

- Super slim head at 1/4" thick by 11/16" wide
- Up to 7 hours of light on a single charge
- Generates 200 lumens at 15 feet
- Micro USB receiver allows for multiple charging options
- 3.7 volt Li-ion / 2200 mah rechargeable battery

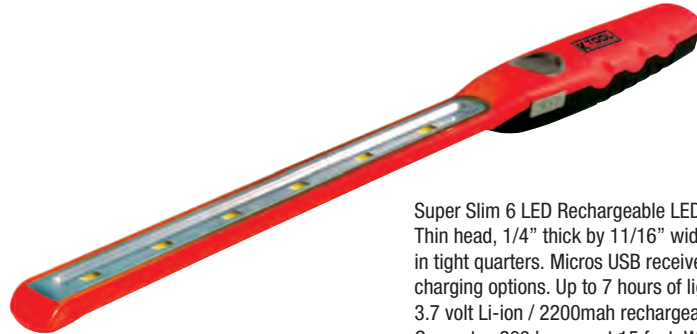

Super Slim 6 LED Rechargeable LED Inspection Lamp. Thin head, 1/4" thick by 11/16" wide allows for inspection in tight quarters. Micros USB receiver allows for multiple charging options. Up to 7 hours of light on a single charge. 3.7 volt Li-ion / 2200mah rechargeable battery. Generates 200 lumens at 15 feet. Weighs only 6 oz.

KTI73399 **Rechargeable 12 SMD** **LED Worklight**

- ABS and rubberized housing with a magnet on the back side and a rotating hook on the top
- Hi / Low / Off switch
- Charge time: 5 hours
- Run time: 2 hours



KTI73387 **Rechargeable Worklight** **3W COB with Pivot Head**

- Rechargeable 3W COB LED
- 3.7 volt 2200 mAH Li battery
- 5 hours with run time being approximately 2 hours
- ABS and rubberized housing
- Super strong magnetic base
- Rotating hook at the top that can be turned down
- 80 degree pivoting head with 180 degree rotating light
- AC & DC chargers included



Warranty information: Lighting covered by a 1-Year Warranty. Bulbs are not covered.

LIGHTING

Hand Held

KTI73388

3 Watt COB

LED Rechargeable Worklight

- 3.7 volt / 22000 mAh Li battery
- Charge time about 5 hours with 2 hour run time
- ABS and rubberized housing with a magnet on the back side and a clip for hanging
- AC & DC chargers included



KTI73396

Aluminum 16 LED Flashlight

- 16 LED (96 lumens) flashlight
- Aerospace grade aluminum body
- Rubber grip handle
- Belt holster included
- 3 - AAA batteries included

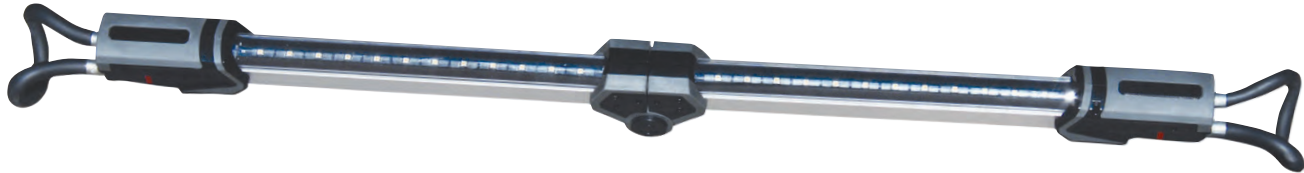

Exclusive Folding Option



KTI73386

Underhood Rechargeable 24 Element 600 Lumen Worklight

- Aluminum and ABS housing
- 7.4 Volt / 2000mAh Lithium-Ion battery with 6 hour charge time and approximately 3.5 hrs run time
- Telescopic ends slide to a maximum of 74.75 inches with soft rubber ends that allow attachment to work area
- AC and DC chargers included
- High-low-off switch
- Full extension length: 50.375 inches; Folded length: 26.875 inches



KTI73398A

Hands-Free LED Head Lamp 3W 120 Lumen

- Powerful 3 watt COB LEDs
- Operating modes: high (100%), low (50%), flashing, off
- Adjustable ratcheting headlamp, 180° up/down, for light direction
- 3 "AAA" batteries included



Warranty information: Lighting covered by a 1-Year Warranty. Bulbs are not covered.



KTI79800

Emergency Safety Flare

- Non-chemical, environmentally safe
- Nine flash patterns including the USCG approved SOS
- Runtime up to 100 hours depending on flash pattern
- Shatter-proof, crush-proof, and water resistant
- Positive buoyancy
- 1 CR-123 battery included

Applications in automotive, industrial, and marine. Nine distinctive flash patterns for emergency situations and work areas. Includes a magnet on one side for attaching to metal surfaces.



KTI79801

Rechargeable Emergency Safety Flare

- Non-chemical safety flare
- Runtime up to 50 hours depending on flash pattern
- Nine flash patterns including the USCG approved SOS
- Shatter-proof, crush-proof, and water resistant
- Non-chemical safety flare
- Positive buoyancy
- Charger adapter included

A non-chemical, environmentally safe flare. Applications in automotive, industrial, and marine. Nine distinctive flash patterns for emergency situations and awareness in work areas. Includes a magnet on one side for attaching to metal surfaces.

Work Lights

KTI73373

24 SMD LED Rechargeable Worklight

- 24 SMD LED (800 lumens) Rechargeable Worklight
- Heavy duty face plate
- Features a ratcheting head
- Foam insulated handle
- On / Off switch
- Charge time: 2 hours
- Run Time: 2 hours full strength

Rechargeable worklight. 24 element SMD LED with 800 lumen output. The face plate is heavy duty that contains the on/off switch on the reverse side. Has a ratcheting head and foam insulated handle. Weight: 4.85 lbs, length: 10.75" width: 9.75", height: 15"



KTI73374

24 SMD LED A/C Power Worklight with 3 foot 18/3 SJTW Cord

- 24 SMD LED (800 lumen) A/C Power Worklight with 3 foot 18/3 SJTW cord
- Heavy duty face plate
- Features a ratcheting head
- Foam insulated handle
- On / Off switch

A/C Power worklight with 3 ft. 18/3 SJTW cord. 24 element SMD LED with 800 lumen output. The face plate is heavy duty that contains the on/off switch on the reverse side. Has a ratcheting head and foam insulated handle. Worklight LED 800 Lumen 3ft 18/. Weight: 4.85 lbs, length: 10.75" width: 9.75", height: 15"



Warranty information: Lighting covered by a 1-Year Warranty. Bulbs are not covered.

LIGHTING

Work Lights

KTI73303 Fluorescent Tube Light 25' 13 Watt 18/2

- Fluorescent work lights are cool to the touch and energy efficient
- All fluorescent lights are UL and cUL approved
- Adjustable hanging hook swivels 360 degree for easy hanging
- On/off switch located in handle.

Length: 25'
Cord: 18/2 SJT
Bulb: 13 watt



KTI73304 Replacement Head 13 Watt Fluorescent Tube Light

- Light head only, no cords attached
- Complete with bulb

R



KTI73359 Trouble Light 50' Metal Cage Standard Duty

- Incandescent trouble lights are ideal for workshops or garages
- Heavy duty metal cage features 360° rotating hanging hook for maximum flexibility
- Switch and outlet in handle.

Length: 50'
Cord: 18/3 SJT
Watt: 1250
Amp: 10



KTI73360 Trouble Light 25' Metal Cage Heavy Duty

- Incandescent trouble lights are ideal for workshops or garages
- Heavy-duty metal cage features 360° rotating hanging hook for maximum flexibility
- Switch and outlet in handle

Length: 25'
Cord: 16/3 SJT
Watt: 1625
Amp: 13



KTI73362 75W Incandescent Trouble Light with Heavy Duty Metal Cage

- 13 Amp, 1625 Watt Nema 5-15 receptacle outlet in handle
- SJT 16/3 AWG, 50 foot cord
- Heavy duty metal cage features rotating hanging hook
- 75 Watt bulb
- 120 Volt



KTI73358 Trouble Light 25' Metal Cage Standard Duty

- Incandescent trouble lights are ideal for workshops or garages
- Heavy duty metal cage features 360 degree rotating hanging hook for maximum flexibility

Length: 25'
Cord: 18/3 SJT
Watt: 1250
Amp: 10

Standard Trouble Light Replacement Parts

- KTI73350** - Replacement metal guard only
- KTI73351** - Replacement handle/switch assembly only
- KTI73355** - Replacement metal guard with handle/switch assembly



R

Warranty information: Lighting covered by a 1-Year Warranty. Bulbs are not covered.

KTI73311
Fluorescent Angle
Work Light 25'
13 Watt 16/3

- Fluorescent work lights are cool to the touch and energy efficient
- UL and cUL approved and have circuit breaker protection and grounded outlet
- All angle lights have 360 degree swivel magnet, rotating clip for hanging and feature protective bumper and special ergonomic grip
- On/off switch

Length: 25'
 Cord: 16/3 SJT
 Bulb: 13 watt
 Amp: 13
 Watt: 1625



KTI73305
Replacement Head
13 Watt Fluorescent
Angle Light

- Light head only, no cords attached
- Complete with bulb

R



KTI73306
Replacement Head
26 Watt Fluorescent
Angle Light

- Light head only, no cords attached
- Complete with bulb

R



KTI73357
Replacement Lens
Angle Light 13 Watt

- Replacement part for fluorescent light

R



KTI73356
Replacement Lens
Angle Light 26 Watt

- Replacement part for fluorescent light

R

KTI73312
Fluorescent Angle
Work Light 25'
26 Watt 16/3

- Fluorescent work lights are cool to the touch and energy efficient
- UL and cUL approved and have circuit breaker protection and grounded outlet
- All angle lights have 360 degree swivel magnet, rotating clip for hanging and feature protective bumper and special ergonomic grip
- On/off switch

Length: 25'
 Cord: 16/3 SJT
 Bulb: 26 watt
 Amp: 13
 Watt: 1625



KTI73397
LED Worklight 48 LED 25ft 16/3

- Super bright 48 LED with 25' 16/3 SJT power cord
- 15 AMP outlet in handle
- Clamped magnet attaches to the center for changing light positions
- Two swivel hooks that fold down can be used for hanging the light

KTI3379A
Trouble Light Retrofit
500 Lumens

- A twist on module that converts an incandescent trouble light in a LED light
- 30 high powered SMD LED (500 lumens)
- Rubber bumper to protect unit
- Folding hanging hook that fits into head



Warranty information: Lighting covered by a 1-Year Warranty. Bulbs are not covered.

LIGHTING

Work Lights

KTI73370

Halogen Work Light 500 Watt

- Illuminate the workshop, garage or job site with the power of bright halogen light
- All KTI fixtures use a 500-watt quartz halogen bulb (included), which emits brighter, whiter light and uses less energy
- Features include: 5-foot power cord and small floor stand

Length: 5'

Cord: 18/3 SJTW

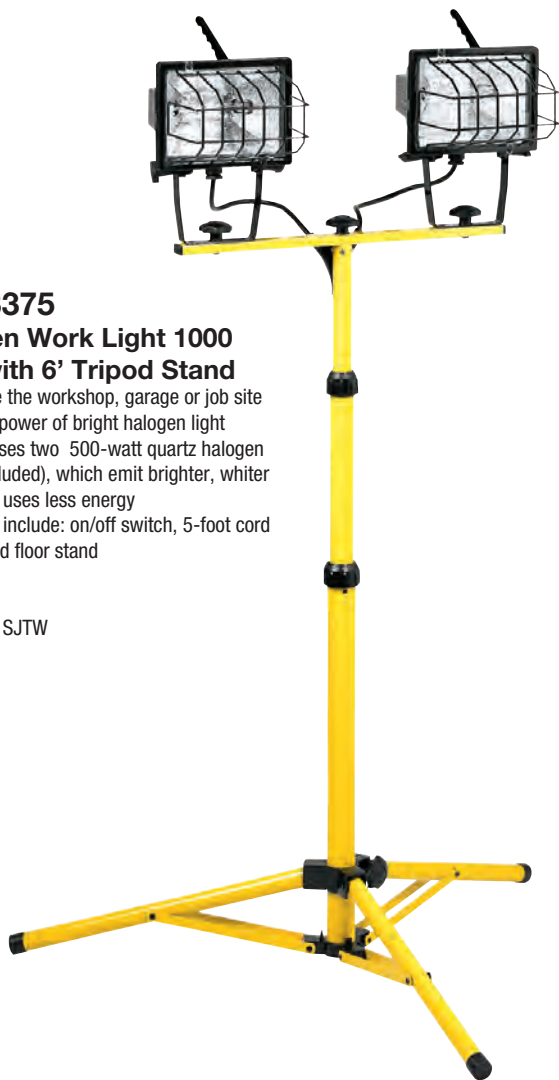

KTI73375

Halogen Work Light 1000 Watt with 6' Tripod Stand

- Illuminate the workshop, garage or job site with the power of bright halogen light
- Fixture uses two 500-watt quartz halogen bulb (included), which emit brighter, whiter light and uses less energy
- Features include: on/off switch, 5-foot cord and tripod floor stand

Length: 5'

Cord: 18/3 SJTW

KTI73372

Halogen Work Light 500 Watt with 6' Tripod Stand

- Illuminate the workshop, garage or job site with the power of bright halogen light
- All KTI fixtures use a 500-watt quartz halogen bulb (included), which emits brighter, whiter light and uses less energy
- Features include: on/off switch, 5-foot cord and 6-foot tripod floor stand

Length: 5'

Cord: 18/3 SJTW



Warranty information: Lighting covered by a 1-Year Warranty. Bulbs are not covered.

KTI73363
Trouble Light 25'
Metal Cage
Industrial Duty

- Incandescent trouble lights are ideal for workshops or garages
- Heavy-duty industrial cage features 360 degree rotating hanging hook for maximum flexibility
- Switch and outlet in handle

Length: 25'
 Cord: 14/3 SJT
 Watt: 1875
 Amp: 15



KTI73349
Replacement
Metal Cage for
Industrial Trouble Light

- Metal guard and cage for use with incandescent trouble lights
- Bulb and light not included

R



KTI73315
13W Fluorescent
Angle Light, reel has
30' retractable cord

- Fluorescent work lights are cool to the touch and energy efficient
- Fluorescent light is cULus approved
- Angle light has 360° swivel magnet, 2 rotating clips for hanging and feature protective bumper and special ergonomic grip
- On/off switch and outlet in handle
- 9 amp, 1125 watt, 125 volt cable reel made of metal
- Retractable SJT cable, 16/3 AWG, 30 foot cord
- 13 watt bulb



KTI73318
Fluorescent Tube Light
on Reel 50'
13 Watt 18/2

- Fluorescent work lights are cool to the touch and energy efficient
- All fluorescent lights are UL and cUL approved
- Adjustable hanging hook swivels 360 for easy hanging
- On/off switch located in handle

Length: 50' with reel
 Cord: 18/2 SJT
 Bulb: 13 watt



KTI73330
75W Incandescent Trouble Light
with Reel, 30' Cord

- Incandescent trouble light with metal housing reel with 9 amps, 125 volt, 1125 watt
- Metal cage protects the 75 watt bulb and has a 360 degree rotating hanging hook
- Circuit breaker protection and Nema 5-15 receptacle grounded outlet in handle
- Reel contains retractable cable 16/3 SJT, 30 foot with 75 watt trouble light
- cULus approval



KTI73335
Industrial Trouble Light on Reel

- Incandescent trouble lights are ideal for workshop or garage environments
- Heavy duty metal shades have 360 rotating hanging hooks provide flexibility for all applications
- Work lights feature circuit breaker protection and grounded outlet in handle

Length: 50'
 Cord: 14/3 SJT
 Dual industrial cage.



Warranty information: Lighting covered by a 1-Year Warranty. Bulbs are not covered.

LIGHTING

Work Lights



KT173335

Industrial Trouble Light on Reel

- Incandescent trouble lights are ideal for workshop or garage environments
- Heavy duty metal shades have 360° rotating hanging hooks provide flexibility for all applications
- Work lights feature circuit breaker protection and grounded outlet in handle

Length: 50'
Cord: 14/3 SJT
Dual industrial cage.



KT173333

26W Fluorescent

Angle Light Reel with 50' Cord

- Fluorescent work lights are cool to the touch and energy efficient
- Fluorescent light has cULus approval
- All angle lights have 360 degree swivel magnet, 2 rotating clips for hanging and feature protective bumper and special ergonomic grip
- On/off switch and outlet in handle
- 8 amp, 125 volt, 1000 watt cable reel is made of plastic with circuit breaker on reel body
- Retractable SJT 14/3, 50 foot cord 26 watts, (2) 13 watt bulbs

Work Light | Accessories

KT173307

Replacement Bulb 13 Watt Fluorescent

- Replacement bulb for all KTI 13 watt work lights (angle and compact tube)



KT173371

Replacement Bulb 500 Watt Halogen

- Replacement bulb for all KTI halogen work lights (models 73370, 73372 and 73375)



Power Reels & Extension Cords



KT173341

Retractable Extension Cord Reel 50'

- Extension reel features oil and water resistant cord, retractable reel, power indicator, lighted end and circuit breaker protection

Length: 50'
Cord: 14/3 SJE0W tri-tap
Amp: 13
Watt: 1625

Warranty information: Lighting covered by a 1-Year Warranty. Bulbs are not covered.

Power Reels & Extension Cords

KTI73340 Retractable Extension Cord Reel 30'

- Extension reel features oil and water resistant cord, retractable reel, metal housing and circuit breaker protection

Length: 30'
Cord: 16/3 SJT tri-tap
Amp: 10
Watt: 1250



All-Weather Extension Cords

- All-weather extension cord features 16/3 SJE0W single tap blue cord
- LED mounted in end of cord lights up when cord is plugged into 110V power
- Cord stays flexible even in extreme temperatures (-58°F to 221°F)
- 16/3 cord; Watt: 1625; Amp: 13

KTI73380 - 25' extension cord
KTI73381 - 50' extension cord

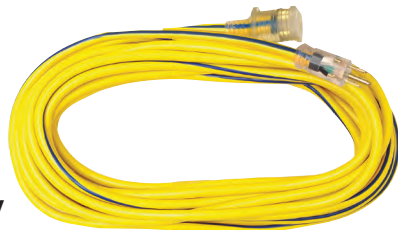

KTI73348 Extra-heavy-duty Extension Cord

- Extra-heavy-duty extension cord features 12/3 SJTW single tap orange/black cord
- LED mounted in end of cord lights up when cord is plugged into 110V power
- Length: 50'; Watt: 1875; Amp: 15

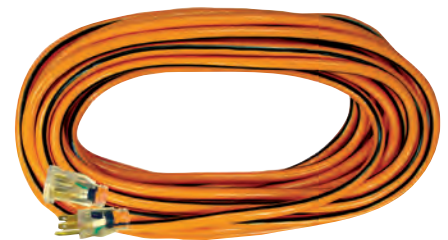

Heavy-duty Extension Cords

- Heavy duty extension cord features 14/3 SJTW single tap orange/black cord
- LED mounted in end of cord lights up when cord is plugged into 110V power
- Watt: 1875; Amp: 15

KTI73345 - 25' extension cord
KTI73346 - 50' extension cord

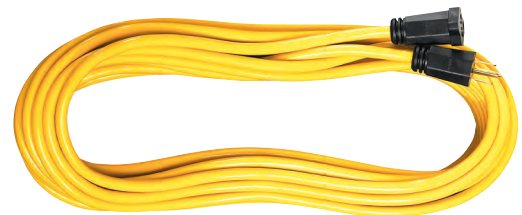

Standard-duty Extension Cords

- Standard outdoor extension cord features 16/3 SJTW single tap yellow cord
- Medium-duty capacity
- Flexible to -40°F. Water and weather resistant
- UL listed; Watt: 1625; Amp: 13; Volt: 125

KTI73342 - 25' extension cord
KTI73343 - 50' extension cord

Warranty information: Lighting covered by a 1-Year Warranty. Bulbs are not covered.



CUTTING/THREADING/ABRASIVES



1.800.762.6002 | www.ktoolinternational.com

KTI10330
326-Piece
Master Drill Bit Set

KTI's Master Drill Bit is a comprehensive set of drill bits and accessories. This 326-piece set includes bits and accessories for nearly every job. The unique storage case fully opens to access the bit and accessories you need. Two (2) bottom trays fold and slide into portable carrying case. Transport from job to job quickly and easily!

Warranty: 90 Day warranty on materials and workmanship.



326-Piece Master Drill Bit Set	
Qty	Description of Contents
64	HSS Twist Drill Bits: 3/64" (8), 1/16" (8), 5/64" (5), 3/32" (5), 7/64" (5), 1/8" (5), 9/64" (5), 5/32" (5), 3/16" (4), 7/32" (4), 15/64", 1/4", 17/64", 9/32", 5/16", 11/32", 3/8", 7/16", 15/32" and 1/2"
54	Titanium Coated High Speed Drill Bits: 3/64" (6), 1/16" (6), 5/64" (4), 3/32" (4), 7/64" (4), 1/8" (4), 9/64" (4), 5/32" (4), 11/64" (4), 3/16" (2), 7/32" (2), 15/64", 1/4", 17/64", 9/32", 5/16", 11/32", 3/8", 7/16", 15/32" and 1/2"
10	Nutdrivers: 5/32", 3/16", 7/32", 1/4", 9/32", 5/16", 11/32", 3/8", 7/16" and 1/2"
37	2" Screwdriver Bits: 7 Slotted, 6 Phillips, 6 Pozi, 8 Star, 7 Metric Hex and 8 Square
64	1" Screwdriver Bits: 14 Slotted, 10 Phillips, 10 Pozi, 8 Star, 7 Hex, 9 Metric Hex and 6 Square
3	14" Masonry Drill Bits: 5/16", 3/8" and 1/2"
21	Masonry Drill Bits: 5/32" (2), 11/64" (2), 3/16" (2), 7/32" (2), 15/64" (2), 1/4" (2), 17/64", 9/32", 5/16", 21/64", 11/32", 3/8", 7/16", 15/32" and 1/2"
4	Nail Punches: 1/32", 1/16", 3/32" and 1/8"
6	Drill Stoppers: 1/8", 5/32", 3/16", 1/4", 5/16" and 3/8"
1	Allen Key - 2.5mm
1	Magnetic Holder
1	Counter Sink
64	HSS Twist Drill Bits: 3/64" (8), 1/16" (8), 5/64" (5), 3/32" (5), 7/64" (5), 1/8" (5), 9/64" (5), 5/32" (5), 3/16" (4), 7/32" (4), 15/64", 1/4", 17/64", 9/32", 5/16", 11/32", 3/8", 7/16", 15/32" and 1/2"
54	Titanium Coated High Speed Drill Bits: 3/64" (6), 1/16" (6), 5/64" (4), 3/32" (4), 7/64" (4), 1/8" (4), 9/64" (4), 5/32" (4), 11/64" (4), 3/16" (2), 7/32" (2), 15/64", 1/4", 17/64", 9/32", 5/16", 11/32", 3/8", 7/16", 15/32" and 1/2"
10	Nutdrivers: 5/32", 3/16", 7/32", 1/4", 9/32", 5/16", 11/32", 3/8", 7/16" and 1/2"
37	2" Screwdriver Bits: 7 Slotted, 6 Phillips, 6 Pozi, 8 Star, 7 Metric Hex and 8 Square
64	1" Screwdriver Bits: 14 Slotted, 10 Phillips, 10 Pozi, 8 Star, 7 Hex, 9 Metric Hex and 6 Square
3	14" Masonry Drill Bits: 5/16", 3/8" and 1/2"
21	Masonry Drill Bits: 5/32" (2), 11/64" (2), 3/16" (2), 7/32" (2), 15/64" (2), 1/4" (2), 17/64", 9/32", 5/16", 21/64", 11/32", 3/8", 7/16", 15/32" and 1/2"
4	Nail Pouch: 1/32", 1/16", 3/32" and 1/8"
6	Drill Stoppers: 1/8", 5/32", 3/16", 1/4", 5/16" and 3/8"
1	Allen Key - 2.5mm
1	Magnetic Holder
1	Counter Sink
1	Gauge

4	Hole Saws: 1-3/4", 2-1/8", 2-3/8" and 2-1/2"
1	Hole Saw Adapter
44	Wood Boring Drill Bits: 1/8" (3), 5/32" (4), 11/64" (8), 3/16" (4), 13/64" (4), 7/32" (4), 15/64" (4), 1/4" (4), 17/64", 9/32", 5/16", 11/32", 3/8", 7/16", 15/32" and 1/2"
5	Flat Wood Bits: 1/2", 5/8", 3/4", 7/8" and 1-1/4"
4	12" Flat Wood Bits: 5/16", 3/8", 1/2" and 9/16"



KTI71200
10-Pack
Double-Ended Drill Bits
 Double-ended, 2" long bits are made of high-speed steel. Ideal for auto body work and sheet metal drilling.

CUTTING/THREADING/ABRASIVES

KTI71233

3-Piece Set Step Drill Bits

- Titanium coated
- High-speed steel (HSS) 4241
- HRC 60-63 (Rockwell Scale)
- Sizes: 1/8" to 1/2", 3/16" to 1/2" & 1/4" to 3/4"
- 1 Year Warranty



Sold separately:

KTI71235 - 1/8" to 1/2"

KTI71236 - 3/16" to 1/2"

KTI71237 - 1/4"-3/4"

LIFETIME WARRANTY*

KTI70040

5-Piece

Spiral Extractor Set

- Made of high carbon steel
- Aggressive spiral design for extra grip on stubborn broken bolts



Sizes include: 1/8" - 1/4", 1 - 6mm; 1/4" - 5/16", 6 - 8mm; 5/16" - 7/16", 8 - 11mm; 7/16" - 9/16", 11 - 14mm; 9/16" - 3/4", 14 - 18mm.

KTI70045

5-Piece

Fluted Extractor Set

- Quickly and easily remove broken screws, pipes, bolts and studs
- Manufactured with heat-treated chrome-moly steel for long wear and durability



LIFETIME WARRANTY*

Sizes range from 1/8"-3/8" and 3 mm-9.5 mm.

KTI73155

Folding Knife - Stainless Steel Satin Finish Blade

- 9Cr18MOV stainless steel satin finished blade
- Stainless steel blade partially serrated with assist opening
- Folded knife length: 4.750", width: 1.438, height: .563; blade shaft length: 3.6875", open knife length: 8.4375"
- G10 handle • Reversible pocket clip



LIFETIME WARRANTY*



KTI73150

Folding Knife - Stainless Steel, Black Finish Blade, Partially Serrated With Assist Opening

- 9Cr18MOV stainless steel black finish blade
- Stainless steel blade partially serrated with assist opening
- Folded knife length: 4.750", width: 1.438", height: .563"; blade shaft length: 3.6875", open knife length: 8.4375"
- G10 handle • Reversible pocket clip

LIFETIME WARRANTY*

KTI73110

Spring Action Scissors

- Spring action soft touch scissors are 10-1/4" long
- Stainless steel blade, spring and screw
- ABS lock
- Nylon fiber handle with soft TPR grips
- Ergonomically designed handle with spring action for lasting use and reducing hand fatigue

LIFETIME WARRANTY*



Spring action scissors are perfect for cutting fabric, ribbon, paper, corrugated paper, string, light cardboard, garden plants and many more items.

KTI73102

Quick Change Folding Utility Knife

- Quick change and folding
- Folded knife length: 4.3125", blade shaft length: 2.750", open knife length: 6.5"
- Plastic body with rubber grip.
- Blade case with 3 blades included.

LIFETIME WARRANTY*



KTI73103

Auto Loading Folding Utility Knife

- Auto loading
- Folded knife length: 4.375", blade shaft length: 2.750", open knife length: 7"
- Zinc body, ABS and rubber grip
- 3 blades included
- Black and red handle

LIFETIME WARRANTY*





KTI73105
Utility Knife

- Retractable 6" utility knife with extra blade storage in handle.

Replacement parts:

KTI70546 - Replacement blades 6-pack



LIFETIME WARRANTY*

KTI73104
Jumbo Monster Knife

- Extra-large grip for added control
- Quick-change blade system
- Includes six (6) snap-off blades
- Knife measures a whopping 8" x 2.5" x 1"

Replacement parts:

KTI73104-1 - Replacement blades 10-pack



KTI70016
Mini Scraper

- Grip-coated handle for better comfort and control
- Angled tip for increased accuracy
- Blade locks securely in place
- Quick and easy blade changes
- Reversible blade for safe storage. Includes one (1) single edge blade.
- Length: 4-1/2" Assorted colors.

KTI72310
Tube Cutter Mini - Range 1/8" to 5/8" OD

LIFETIME WARRANTY*

- Cuts 1/8" to 5/8" OD tubing
- Compact size for use in confined areas
- Features rollers to ease operation.



KTI72330
Tubing Cutter Heavy-duty

- Cuts 1/8" to 1-1/8" OD tubing
- Heavy-duty rollers smooth operation



LIFETIME WARRANTY*



LIFETIME WARRANTY*

KTI72355
Ratcheting Hose and Pipe Cutter

- Cut a variety of material
- Ratcheting action makes cutting smooth and easy
- Cuts material up to 1-1/2" diameter
- One-touch, quick-release lever opens pliers instantly
- Built-in clasp securely locks handles when not in use for added safety

Replacement parts:

KTI72355-1 - Replacement blade



KTI72320
Tubing Bender - U.S.-made

Bends 3/16", 1/4", 5/16" and 3/8" diameter tubing. Features aluminum mandrel.



LIFETIME WARRANTY*



KTI72340
Tubing Bender

Bends 1/4", 5/16" and 3/8" OD aluminum, steel and copper tubing.

LIFETIME WARRANTY*



KTI72345
Tubing Bender Heavy-duty Pliers

Bends 3/16", 1/4", 5/16" and 3/8" diameter copper and steel tubing without collapsing or kinking.

LIFETIME WARRANTY*

CUTTING/THREADING/ABRASIVES

Center Cut Bolt Cutters

- Heavy duty cutters
- Heat-treated chrome vanadium alloy jaws
- Specially designed curved handles for more efficient strength application and comfortable rubber handles for firm and safe grip

Sold separately:

KTI57124 - 24" Center Cut Bolt Cutter

KTI57130 - 30" Center Cut Bolt Cutter

KTI57136 - 36" Center Cut Bolt Cutter

Replacement parts:

KTI57224 - Replacement head 24"

KTI57236 - Replacement head 36"



LIFETIME WARRANTY*

KTI57514

14" Wire & Rope Cutter

- Shear-cut blades hold and lock cable in cutting position for a clean, sharp cut
- Chrome-vanadium cutting head
- Designed for cutting wire rope, piano wire, steel wire, ACSR cable and aircraft cable
- 14" overall length

LIFETIME WARRANTY*



Center Cut



Clipper Cut Bolt Cutters

- Blades are flush against one face for cutting against flat surfaces
- Heavy duty cutters
- Heat-treated chrome vanadium alloy jaws
- Specially designed curved handles for more efficient strength application and comfortable rubber handles for firm and safe grip

Sold separately:

KTI57318 - 18" Clipper Cut Bolt Cutter

KTI57324 - 24" Clipper Cut Bolt Cutter

KTI57330 - 30" Clipper Cut Bolt Cutter

KTI57336 - 36" Clipper Cut Bolt Cutter

LIFETIME WARRANTY*



Clipper Side Cut



Angled Head Clipper Cut Bolt Cutters

- Angled for easier insertion and keeping work in view
- Heavy duty cutters
- Heat-treated chrome vanadium alloy jaws
- Specially designed curved handles for more efficient strength application and comfortable rubber handles for firm and safe grip

Sold separately:

KTI57414 - 14" Clipper Cut Bolt Cutter

KTI57424 - 24" Clipper Cut Bolt Cutter

KTI57436 - 36" Clipper Cut Bolt Cutter

LIFETIME WARRANTY*



Clipper Side Cut





PROFESSIONAL TOOLS & EQUIPMENT



CUTTING/THREADING/ABRASIVES



KT173400 Number and Letter Stamp Set - Size 3/16"

- Combination set includes 3/16" set of numbers and 3/16" set of letters
- Includes convenient storage case

**LIFETIME
WARRANTY***



KT170010 Tapered Scratch Awl

- High quality chrome vanadium steel
- Ergonomic, contoured handle
- Used for scribing, punching holes and lining up panels or holes.

**LIFETIME
WARRANTY***



KT172380 8" Straight Cut Tin Snips

- One piece drop forged construction of high carbon steel
- Cushion handle with smooth, comfortable bows for ease in use and safety
- Designed for cutting straight and wide curves to the left or right
- Cuts up to .61mm cold rolled steel or .41mm stainless steel
- Cutting blades open to approximately 4" wide
- Induction hardened cutting edges 54-58 HRC



KT172801 12" Tubular Hacksaw

- Top quality, sturdy hacksaw
- Adjustable tensioner
- Includes one (1) saw blade.

**LIFETIME
WARRANTY***



KT172802 Extra Heavy Duty Hacksaw

- All metal heavy duty frame
- High leverage tensioner blade can be set at 45 degrees or vertical
- Handle with blade storage compartment

**LIFETIME
WARRANTY***





KTI71303



KTI71300

Abrasive Cut-off Discs

KTI71303 - 3" x 1/32" - 6 pack

KTI71306 - 3" x 1/16" - 6 pack

KTI71301 - 3" x 1/16" - 25 pack

KTI71300 - 3" x 1/16" - 50 pack

KTI70013

Cut-off Wheel Arbor

Drill adapter for cut-off discs. Fits any drill with a chuck capacity of 1/4" or larger.



KTI74103

3-Piece Mini Brush Set

Set includes one brass, nylon and stainless steel brush. Features molded poly handles. Overall length: 7"



Set includes (also available individually):

KTI74106 - Brass

KTI74107 - Nylon

KTI74108 - Steel

Spindle Adapters

KTI87140

3/8" - 24 ID thread

5/8" - 11 OD thread

KTI87141

10mm - 1.25mm ID thread

5/8" - 11 OD thread



KTI79220



KTI79215



KTI79216



KTI79210



KTI79217



KTI79201

WIRE WHEEL AND CUP BRUSHES

Part #	Type	Diameter	RPM	Type of Mount
KTI79200	Crimped wire wheel - narrow face	6" diameter	6,000 maximum	1/2" x 5/8" hole center mount
KTI79201	Crimped wire wheel - medium face	6" diameter	6,000 maximum	1/2" x 5/8" hole center mount
KTI79205	Crimped wire wheel - wide face	8" diameter	6,000 maximum	1/2" x 5/8" hole center mount
KTI79210	Crimped wire cup - coarse	1" diameter	4,500 maximum	1/4" stem mount
KTI79215	Crimped wire cup - coarse	2" diameter	4,500 maximum	1/4" stem mount
KTI79216	Crimped wire cup - coarse	3" diameter	4,500 maximum	1/4" stem mount
KTI79217	Crimped wire wheel - coarse	3" diameter	4,500 maximum	1/4" stem mount
KTI79220	Knotted wire cup - extra coarse	2 3/4" diameter	12,500 maximum	5/8" x 11 thread
KTI79225	Crimped wire cup - coarse	3" diameter	12,500 maximum	5/8" x 11 thread

Note: Always wear eye protection. Keep loose articles of clothing and jewelry from moving parts.

Utility Brushes

Wood handle brushes have natural bristles not affected by thinners or other solvents.

Sold separately:

KTI74005 - 1/2" width

KTI74010 - 1" width

KTI74015 - 1-1/2" width

KTI74020 - 2" width

KTI74025 - 2-1/2" width

KTI74030 - 3" width





AIR TOOLS & ELECTRIC TOOLS



1.800.762.6002 | www.ktoolinternational.com

Air Tools | Ratchets

1/4"

KTI82500A
1/4" Drive Air Ratchet

- 25 ft./lb. ultimate torque
- 250 rpm
- 2 CFM air consumption
- 7" overall length
- 90 PSI air pressure (recommended)



Warranty: Repair only up to 1 year

3/8"

KTI82503A
3/8" Drive Air Ratchet

- 50 ft./lb. ultimate torque
- 170 rpm
- Designed for reliability and superior performance
- 6 CFM air consumption, 90 PSI air pressure recommended
- 10" overall length



Warranty: Repair only up to 1 year

3/8"

KTI82504
3/8" Drive Heavy Duty Air Ratchet

- 55 ft./lb. ultimate torque
- Designed for reliability and superior performance
- 170 RPM, 6 CFM air consumption, 90 PSI air pressure recommended
- 11" overall length



Warranty: Repair only up to 1 year

AIR RATCHET SPECIFICATIONS							
Part #	RPMs	Sq. Drive	Working Torque	Ultimate Torque	Length	Weight	CFMs
KTI82500A	250 rpm	1/4"	5-20 ft./lbs.	25 ft./lbs.	7"	1.00 lb.	2 CFM
KTI82503A	170 rpm	3/8"	10-60 ft./lbs.	50 ft./lbs.	10"	2.60 lb.	6 CFM
KTI82504	170 rpm	3/8"	10-55 ft./lbs.	55 ft./lbs.	11"	3.00 lb.	6 CFM

Air Tool Warranty Information

K-Tool International air tools are warranted against defects in workmanship for one (1) year from the date of purchase*. We will repair or replace, at our option, any defective part or unit which proves to be defective in material or workmanship within the warranty period. Should an air tool fail within the first 30 days after purchase date, it may be returned to the place of purchase for a free replacement*. The foregoing obligation is K-Tool International's sole liability under this or any implied warranty, and under no circumstances, shall it be liable for any incidental or consequential damages.

This warranty applies to the basic tool. It does not apply to normal wear and tear on attached accessories/consumable products, such as drill chucks, backing pads for sanders, punch and die for nibblers, air hammer retainers, spray gun cups or "kit" accessories, etc.

*Repairs required as a result of abuse, misuse, damage or repair attempts made by others are not covered by this warranty.

AIR TOOLS & ELECTRIC TOOLS

Air Tools | Impact Wrenches

KT181550 Butterfly

3/8" Drive Impact Wrench

The popular Butterfly 3/8" drive with built-in power regulator features instant forward and reverse throttle speed. Streamline design eliminates 2 piece housing construction for excellent power-to-weight ratio. Rear exhaust.

- 11,000 rpm;
- 3/8" square drive
- 5-50 ft./lbs. working torque
- 75 ft/lbs Ultimate Torque
- 3 CFM average air consumption

Warranty: Repairable up to 1 year



KT181565 3/8" Drive Air Impact Wrench

- 320 ft./lb. ultimate torque
- 9000 rpm
- 3 CFM air consumption
- 90 PSI air pressure (recommended)

Warranty: Repairable up to 1 year



KT181560 Pistol Grip 3/8" Drive Impact Wrench

Unlike "nose heavy" pistols, this tool is perfectly balanced.

- 11,000 rpm
- 3/8" square drive
- 5-50 ft./lbs. working torque
- 75 ft./lbs. ultimate torque
- 5" length; 2.5 lbs.
- 3 CFM average air consumption

Warranty: Repairable up to 1 year



KT181622 1/2" Drive Impact Wrench

Features a full polished tool, reversing trigger, "Rocking Dog" clutch and built-in power regulator. Working torque range of 25-180 ft/lbs.

Applications: transmissions, body shops and general repair.

- 260 ft./lb. ultimate torque
- 7000 rpm
- 4 CFM air consumption
- 90 PSI air pressure (recommended)

Warranty: Repairable up to 1 year



KT181631A 1/2" Drive Air Impact Wrench

- 450 ft./lb. ultimate torque
- 7500 rpm
- 7 CFM air consumption
- 90 PSI air pressure (recommended)

Warranty: Repairable up to 1 year



KT181632A 1/2" Drive Air Impact with Extended Anvil

- 450 ft./lb. ultimate torque
- 7500 rpm
- 7 CFM air consumption
- 90 PSI air pressure (recommended)

Warranty: Repairable up to 1 year



IMPACT WRENCH SPECIFICATIONS

Part #	RPMs	Sq. Drive	Working Torque	Ultimate Torque	Length	Weight	CFMs
KT181550	11,000	3/8"	5-50 ft./lbs.	75 ft./lbs.	5-1/2"	2.00 lbs.	3 CFM
KT181560	11,000	3/8"	5-50 ft./lbs.	75 ft./lbs.	5"	2.50 lbs.	3 CFM
KT181565	9,000	3/8"	25-300 ft./lbs.	320 ft./lbs.	8"	3.0 lbs.	3 CFM
KT181622	7,000	1/2"	25-180 ft./lbs.	260 ft./lbs.	7"	5.50 lbs.	4 CFM
KT181631A	7,500	1/2"	25-350 ft./lbs.	450 ft./lbs.	8"	6.0 lbs.	7 CFM
KT181632A	7,500	1/2" - 2" ext	25-300 ft./lbs.	450 ft./lbs.	10"	5.60 lbs.	7 CFM

KTI81772A
3/4" Drive
High Performance
Impact Wrench

- 4,500 rpm
- 3/4" square drive
- 100-500 ft./lbs. working torque
- 800 ft./lbs. ultimate torque
- 11.25" length; 11.55 lbs.
- 5 CFM average air consumption
- High torque developing clutch

Warranty: Repairable up to 1 year



KTI81775
3/4" Drive Heavy-Duty
High Power Impact Wrench

- 900 ft./lb. ultimate torque
- 7000 rpm
- 8 CFM air consumption
- 90 PSI air pressure (recommended)

The ultimate in 3/4" impacts. The big brother to the KTI81631 with the high power twin hammer clutch, making this the wrench for all 3/4" applications, including all the hardest jobs, such as springs, tractor pad removal, farm equipment, truck tires, truck suspension and construction equipment.

Warranty: Repairable up to 1 year



KTI81774
3/4" Drive
Air Impact Wrench

- 1200 ft./lb. ultimate torque
- 4500 rpm
- 8 CFM air consumption
- 90 PSI air pressure (recommended)

Warranty: Repairable up to 1 year



KTI81798A
1" Drive
Impact Wrench
with 6" Extension Anvil

- 1600 ft/lbs of torque
- 6" extended anvil for extra access
- 3 forward and 3 reverse power settings
- D Side handle for ease of use
- Side exhaust directs air away from the job

Covered by a 1 year limited warranty. Repairable under warranty up to a year.



KTI81795
1" Drive
Air Impact Wrench with
13 Piece SAE Socket Set

- 1500 ft./lb. ultimate torque
- 3500 rpm
- 8 CFM air consumption
- 90 PSI air pressure (recommended)

KTI's air tools are designed for reliability and superior performance. Includes 13-piece 1" drive short fractional impact socket set including sizes 3/4" to 3" (KTI35113).

Warranty: Repairable up to 1 year



KTI81797A
Composite Heavy Duty
Air Impact Wrench 1"

- Clutch Type: Twin Hammer
- Air consumption: 47 SCFM
- Free Speed: 4500 rpm
- Working Torque: 1600 ft-lbs
- Maximum Torque: 1800 ft-lbs



IMPACT WRENCH SPECIFICATIONS

Part #	RPMs	Sq. Drive	Working Torque	Ultimate Torque	Length	Weight	CFMs
KTI81772A	4,500	3/4"	100-500 ft./lbs.	800 ft./lbs.	11-1/4"	11.55 lbs.	5 CFM
KTI81774	4,500	3/4"	100-950 ft./lbs.	1,200 ft./lbs.	14"	15 lbs.	8 CFM
KTI81775	7,000	3/4"	200-600 ft./lbs.	900 ft./lbs.	15-5/8"	11.50 lbs.	8 CFM
KTI81795	3,500	1"	100-1,100 ft./lbs.	1,500 ft./lbs.	20"	15 lbs.	8 CFM
KTI81797A	4,500	1"	1,600 ft./lbs.	1,800 ft./lbs.	16"	14.123 lbs.	47 SCFM
KTI81798A	4,000	1"	100-1,200 ft./lbs.	1,600 ft./lbs.	22-1/2"	26.2 lbs.	10 CFM

AIR TOOLS & ELECTRIC TOOLS

Air Tools | Drills

KT184218 3/8" Air Drill

- 2,200 rpm
- 3/8" Keyed Chuck
- Whisper Quiet



Lightweight whisper quiet 3/8" drill, with all ball and needle bearing spindle component support and machined planetary gearing.

Warranty: Repairable up to 1 year

KT184228 3/8" Reversible Air Drill

- 2,000 rpm
- 3/8" Keyed Chuck
- 4 CFM air consumption
- Handle exhaust
- 3/8"-24 spindle



Features through handle muffled exhaust, controllable speed through the teasing trigger and all ball and needle bearing component support.

Warranty: Repairable up to 1 year

KT187130 1/4" Straight Air Drill without Chuck

- 2,500 rpm
- 4 CFM air consumption
- 1/4" air inlet • 1.9 lbs.



Capacity designed for work in close quarters. Durable, light-weight design.

Warranty: Repairable up to 1 year

KT184229 1/2" Heavy-Duty Reversible Drill

- 800 rpm
- 1/2" Keyed Chuck
- Reversible
- Trigger Speed Control
- Handle exhaust
- 4 CFM air consumption



This 1/2" reversible drill is unsurpassed with its whisper quiet through handle exhaust, controllable speed through the teasing trigger and all ball and needle bearing spindle component support.

Warranty: Repairable up to 1 year

DRILL SPECIFICATIONS

Part #	RPMs	Chuck Size	Spindle	Length	Weight	CFMs
KT187130	2,500 rpm	1/4" chuck	3/8" - 24 spindle	7" length	1.9 lbs.	4 CFM
KT184218	2,200 rpm	3/8" chuck	3/8" - 24 spindle	6 1/2" length	2.25 lbs.	4 CFM
KT184228	2,000 rpm	3/8" chuck	3/8" - 24 spindle	7 1/2" length	3.00 lbs.	4 CFM
KT184229	800 rpm	1/2" chuck	3/8" - 24 spindle	9" length	4.00 lbs.	4 CFM

Air Tools | Air Hammers

KT183275 Regulated Air Hammer

- Independent power regulators and teasing throttle for operator control
- All metal one-piece housing with hardened alloy steel barrel and standard .401" shank opening
- 3500 BPM; 2-5/8" stroke; 3/4" bore; 6-3/4" length; 3.5 lbs; 4 cfm



Warranty: Repairable up to 1 year

KT183277 Regulated Long Air Hammer

- Extra long barrel provides a harder hitting blow
- Independent power regulators
- Teasing throttle for operator control
- All metal 1-piece housing
- Hardened alloy steel barrel and standard .401" shank opening.



Warranty: Repairable up to 1 year

AIR HAMMER SPECIFICATIONS

Part #	BPM's	Shank	Stroke	Bore	Length	Weight	CFMs
KT183277	2,000 blows per min.	.401" shank	3-1/2" stroke	3/4" bore	9" length	4.00 lbs.	4 CFM
KT183275	3,500 blows per min.	.401" shank	2-5/8" stroke	3/4" bore	6-3/4" length	3.50 lbs.	4 CFM

Air Tools | Accessories

KT181900 4-Piece Pneumatic Bit Set

Includes panel cutter, cold chisel, hammer bit and scraper.



LIFETIME WARRANTY*

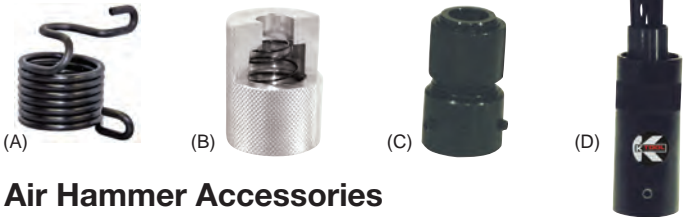

Air Hammer Accessories

- KT183091**
Bee hive quick-change retainer. (A)
- KT183092**
One-piece safety bit retainer. (B)
- KT183093**
Heavy-duty quick-change retainer. (C)
- KT183090**
Needle scaler attachment. (D)

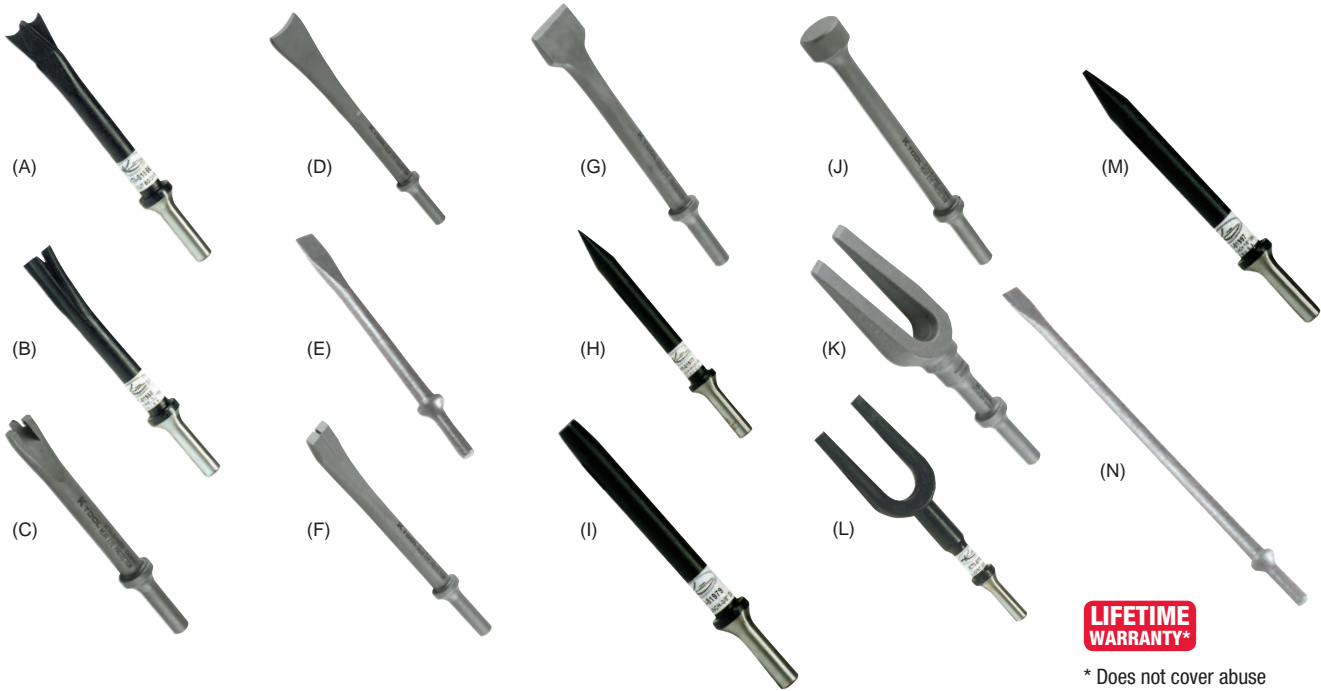

LIFETIME WARRANTY*

* Does not cover abuse

PNEUMATIC BITS					
Part #	Description	Part #	Description	Part #	Description
KT181956	Double cut body ripper (A)	KT181974	10" cold chisel (E)	KT181995	Tie rod separator (K)
KT181958	Slotted panel cutter (B)	KT181975	Rivet and bolt cutter (F)	KT181996	Ball joint separator (L)
KT181959	Sheet metal trimmer (C)	KT181976	Scraper (G)	KT181997	1/8" Taper punch (M)
KT181968	Tail pipe cut-off (D)	KT181977	Taper punch sharp point (H)	KT181986	18" Cold chisel (N)
KT181972	6" cold chisel	KT181979	3/8" Taper punch (I)		
KT181973	8" cold chisel	KT181982	Long hammer (J)		

AIR TOOLS & ELECTRIC TOOLS

Air Tools | Die Grinders

KT187132 Rear Exhaust Die Grinder

- 22,000 rpm
- 1/4" collet
- 2 CFM average air consumption



Die grinder features a powerful 1/2 HP motor, built-in power regulator, variable speed throttle control and full ball bearing construction. Standard with 1/4" collet. Specifications: 22,000 rpm; 1/4" collet; 5-1/2" length; 14 oz. weight; 2 cfm average air consumption.

Warranty: Repairable up to 1 year

KT187125 Mini Rear Exhaust Die Grinder

- 25,000 rpm
- 1/4" collet
- 2 CFM air consumption



Die grinder features full bearing support air motor, rear exhaust independent power regulator and variable speed throttle. Complete with 1/4" collet. Angle head is full bearing construction with a grease fitting for external lubrication. Specifications: 25,000 rpm; 5 1/2" length; 1/4" collet; 2 cfm air consumption.

Warranty: Repairable up to 1 year

KT187126 Rear Exhaust Angle Die Grinder

- 18,000 rpm
- 1/4" collet
- 4 CFM air consumption



Die grinder features full bearing support air motor, rear exhaust independent power regulator and variable speed throttle. Complete with 1/4" collet. Angle head is full bearing construction with a grease fitting for external lubrication. Specifications: 18,000 rpm; 5-3/4" length; 1/4" collet; 4 CFM air consumption.

Warranty: Repairable up to 1 year

KT187128 Gearless Angle Die Grinder

- 25,000 rpm
- 1/4" collet
- 4 CFM air consumption



Tool features drop-in motor, rear exhaust and enhanced muffler system. Lightweight, thermally insulated composite housing reduces vibration. Hardened steel cylinder maximizes air utilization. Grinder's 1/4" collet accepts 1/8", 1/4", 3mm and 6mm shanks.

Warranty: Repairable up to 1 year

KT187135 Die Grinder

- Air die grinder, 3/4 HP with front exhaust system
- Free Speed: 24,000rpm
- Collet size: 1/8" - 1/4"
- Air inlet: 1/4", suggested air pressure: 90psi, average air consumption: 12cfm
- Low vibration facilitates improved working conditions, vibration level less than 2.5m/s²
- 1 Year Warranty



DIE GRINDER SPECIFICATIONS

Part #	RPMs	Collet Size	Length	Weight	CFMs
KT187132	22,000 rpm	1/4" collet	5-1/2" length	1.00 lb.	2 CFM
KT187125	25,000 rpm	1/4" collet	5-1/2" length	14 oz.	2 CFM
KT187126	18,000 rpm	1/4" collet	5-1/2" length	14 oz.	4 CFM
KT187128	25,000 rpm	1/4" collet	6-1/4" length	14 oz.	4 CFM
KT187135	24,000 rpm	1/8" - 1/4" collet	???? length	?? oz.	12 CFM

Air Tools | Sanders & Polishers

KT185800

Dual Piston In-line Sander / File

- Sander features a four-cylinder systems
- Double acting pistons constantly work in opposition to each other, resulting in more power and a smoother, more reliable tool
- Specifications: 3,000 rpm; 1" stroke; 2-3/4" x 15-3/4" pad; 15-3/4" length; 6.5 lbs.; 6 CFM average air consumption.

Warranty: Repairable up to 1 year



KT185265

Air Sander

High Speed 5"

- 2,000 - 18,000 rpm variable
- 3 Pad sizes included

Variable speed (2,000-18,000) pistol grip 1/2 HP sander features one-piece all metal housing, independent power regulator and teasing trigger. Includes 3", 4" and 5" pads. Ideal for removing paint and rust, shaping filler patches and smoothing welds. Specifications: 18,000 rpm; 6 1/2" length; 3.5 lbs.; 6 CFM average air consumption.

Warranty: Repairable up to 1 year



KT185746

"Quiet" Dual-Action Sander

- Built-in speed regulator and variable speed trigger
- Shielded ball bearing for longer life with smooth harmonics
- 6" flexible foam sanding pad with vinyl
- Specifications: 10,000 rpm; 6" pad; 8-1/4" length; 4 lbs.; 4 CFM average air consumption.

Warranty: Repairable up to 1 year



KT185846

High Performance

"Quiet" Dual-action Sander

- Produce a far superior blending and smoothing of filler, feather edging and pre-paint preparation
- High efficiency motor and an all steel balancer body and steel spindle lock nut
- Crossbolt-style hub mounting which minimizes vibration
- Specifications: Heavy Duty, 6" Diameter Pad, 10,000 RPM, 90 PSI, 1/2 HP, 4 CFM, 3/8" hose inlet, Length: 8-1/4", Weight: 4 lbs

Warranty: Repairable up to 1 year

AIR TOOLS & ELECTRIC TOOLS

Air Tools | Sanders & Polishers

KT185807

7" Horizontal Air Sander

- 7" diameter pad
- Includes a multiposition handle for a variety of uses and ergonomic comfort
- Designed for reliability and superior performance
- 2800 RPM
- 1/4" NPT air inlet, 7 cfm air consumption
- 90 PSI air pressure recommended.



Warranty: Repair only up to 1 year

SANDERS & POLISHERS SPECIFICATIONS

Part #	RPMs/Strokes	Pad Size	Length	Weight	CFMs
KT185265	18,000 rpm	3", 4" and 5" inch pads	6-1/2"	3.50 lbs.	6 CFM
KT185746	10,000 rpm	6" pad	8-1/4"	4.00 lbs.	4 CFM
KT185846	10,000 rpm	6" pad	8-1/4"	4.00 lbs.	4 CFM
KT185800	3,000 rpm	2-3/4" x 15-3/4" pad	15-3/4"	6.50 lbs.	6 CFM
KT185807	2,800 rpm	7" pad	16"	6.00 lbs.	7 CFM

Air Sander Accessories



KT185004

High Speed Sander - 4-1/2" pad (A)

KT185005

High Speed Sander - 5" pad (B)

KT185006

3-Piece
High Speed Sander Pad Set (3", 4-1/2", 5") (C)

KT185811

Aluminum Pad Assembly
Jitterbug Sander



KT185811

Air Polisher Accessories

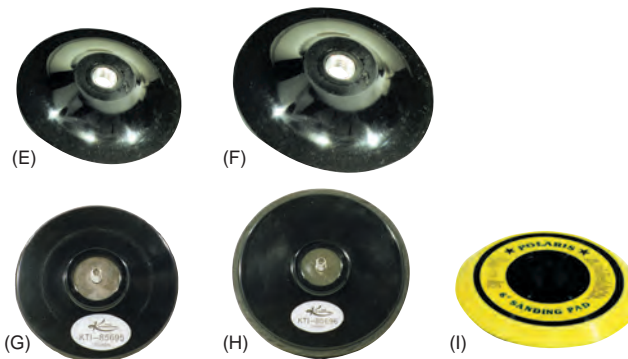

KT185007

5" Deluxe Phenolic Pad (E)

KT185008

7" Deluxe Phenolic Pad (F)

KT185695

5" Dual-Action Bonded Pad. Vinyl face (G)

KT185696

6" Dual-Action Bonded Pad. Vinyl face (H)

KT185697

6" Dual-Action Flex Pad. Yellow Vinyl (I)

Air Tools | Specialty Tools



KT189275 Needle Scaler Standard Duty

- Standard duty, pistol grip
- 3,500 BPM with teasing trigger
- Independent regulators

Warranty: Repairable up to 1 year



KT189257 Straight Line Needle Scaler

- Straight line needle scaler with lever throttle
- 3500 RPM, 4000 bpm, average air consumption 3.5 CFM, air inlet 1/4", air hose 3/8"
- 3mm diameter needles, 6" needle length, 19 needles included
- Bore diameter 1"
- Tool length 18"

Warranty: Repairable up to 1 year



KT183280 Industrial Weld Flux Needle Scaler

- Converts to a standard scaler in seconds
- Simple "J" slot adjustment for needle wear or to provide more needle exposure
- Positive lock retainer
- 4,600 blows per minute.

Warranty: Repairable up to 1 year



KT189276 Pneumatic Scaler

- Pneumatic needle scaler with double spring pistol grip; 3400-4200 bpm
- Lever throttle contains O-rings to limit air leakage
- Clamp on style side handle pivots 360° and is lockable
- Uses 3mm diameter needles
- Comes in black blowmold case and includes 1 side handle grip, 1 oil pot, 1 steel bushing 3/8" NPT x 1/4" NPT, tube of grease lubricant, 2 replacement O-rings and 19 needles (3mm)

Warranty: Repairable up to 1 year

NEEDLE SCALER SPECIFICATIONS

Part #	BPMs	Stroke Length	Length	Weight	CFMs
KT189275	3,500 blows per min.	2-5/8" stroke	12"	4.50 lbs.	4 CFM
KT183280	4,600 blows per min.	1-1/8" stroke	15"	6.00 lbs.	5 CFM
KT189257	4,000 blows per min.	1/8" stroke	18"	6.2 lbs.	3.5 CFM
KT189276	4,200 blows per min.	1-3/10" stroke	18.25"	9 lbs.	2 CFM

AIR TOOLS & ELECTRIC TOOLS

Air Tools | Specialty Tools



KTI88255 Utility / Muffler Cut-off Tool

- 20,000 rpm
- Use with 3" Diameter Abrasive Discs
- Cutting shield

Cuts through muffler clamps, hangers, sheet metal, radiator hose clamps, rusted bumper bolts and steel rods up to 3/4" thick. Standard equipment includes an abrasive 3" disc cutter, independent power regulator, a hand guard trigger and see through cutting shield.

Warranty: Repairable up to 1 year



KTI89218 Air Shear Cutter

- Cut up to 180" per minute
- 18 gauge capacity
- 360° head rotation

Pistol grip, through handle exhaust, high speed 180" per minute cutting capacity in 18 gauge sheet metal. This tool features variable speed control, full ball bearing construction and hardened planetary gear system. The shear head can be positioned in any 360° rotation from the handle for ease of work.

Warranty: Repairable up to 1 year

Replacement parts:

KTI89220 - Replacement Shear Head Attachment



KTI89110 Air Hydraulic 3/16" Rivet Gun

- 4 nose pieces
- Air relief valve

Rugged tool sets rivets up to 3/16" OD. Includes 4 standard-size nose pieces: 3/32", 1/8", 5/32" and 3/16". Air relief prevents overloading and increase life. Side air inlet. Specifications: 75-80 recommended psi; 3/16" capacity; 4.5 CFM average air consumption.

Warranty: Repairable up to 1 year



KTI89115 Air Hydraulic 1/4" Rivet Gun

- 6 nose pieces
- Includes a separate head assembly for steel rivets up to 3/16"

Rugged tool sets rivets up to 1/4" OD. Includes 6 standard-size nose pieces: 3/32", 1/8", 5/32", 3/16", 7/32", 1/4". Includes complete head assembly (jaws and pusher) for 3/32" through 3/16" steel rivets. Specifications: 75-80 recommended psi; 1/4" capacity; 4.5 lbs.; 4.5 CFM average air consumption.

Warranty: Repairable up to 1 year

SPECIFICATIONS

Part #	Strokes/RPMs/PSI	Capacity	Length	Weight	CFMs
KTI89218	2,800 strokes per min.	18 gauge capacity	8-1/2" length	3.50 lbs.	4 CFM
KTI88255	20,000 rpm	3/4" capacity	8" length	2.05 lbs.	4 CFM
KTI89110	75-80 psi (recommended)	3/16" capacity	10.8 Length	3.25 lbs.	4.5 CFM
KTI89115	75-80 psi (recommended)	1/4" capacity	12.5 Length	4.50 lbs.	4.5 CFM



Air Tools | Blow Guns



KTI71010

Air Blow Gun Rubber Tip 1/2"

- Air blow gun with heavy duty aluminium die cast body
- Exclusive Venturi mechanism combines ambient air with compressed air boosting output by 15%
- Output air discharge can be varied by the pistol handle
- Conforms to OSHA standard for both safety & noise
- Inlet threaded 1/4" NPT (F)
- 1 year warranty



KTI71011

Air Blow Gun Standard

- Air blow gun with heavy duty aluminium die cast body
- Exclusive Venturi mechanism combines ambient air with compressed air boosting output by 15%
- Output air discharge can be varied by the pistol handle
- Conforms to OSHA standard for both safety & noise
- Inlet threaded 1/4" NPT (F)
- 1 year warranty



KTI71012

Air Blow Gun High Flow Safety

- Air blow gun with heavy duty aluminium die cast body
- Exclusive Venturi mechanism combines ambient air with compressed air boosting output by 15%
- Output air discharge can be varied by the pistol handle
- Conforms to OSHA standard for both safety & noise
- Inlet threaded 1/4" NPT (F)
- 1 year warranty



KTI71013

Air Blow Gun Soft Rubber Star Tip

- Air blow gun with heavy duty aluminium die cast body
- Exclusive Venturi mechanism combines ambient air with compressed air boosting output by 15%
- Output air discharge can be varied by the pistol handle
- Conforms to OSHA standard for both safety & noise
- Inlet threaded 1/4" NPT (F)
- 1 year warranty



KTI71015

Air Blow Gun Kit - 4 Tips

- General purpose air blow gun kit. Includes 4 popular field interchangeable tips
- Exclusive Venturi mechanism combines ambient air with compressed air boosting output by 15%
- Output air discharge can be varied by the pistol handle
- Conforms to OSHA standard for both safety & noise
- Inlet threaded 1/4" NPT (F)
- 1 year warranty



KTI71016

Air Blow Gun Kit - 7 Tips

- Industrial air blow gun kit. Includes 7 popular field interchangeable tips
- Exclusive Venturi mechanism combines ambient air with compressed air boosting output by 15%
- Output air discharge can be varied by the pistol handle
- Conforms to OSHA standard for both safety & noise
- Inlet threaded 1/4" NPT (F)
- 1 year warranty

AIR TOOLS & ELECTRIC TOOLS



BluBird Rubber Air Hoses

- 100% rubber air hose
- Heavy duty, ultra light weight and super strong
- 300 PSI, NPT fittings with brass ferrules and a bend restrictor to reduce kinking
- Stays flexible in temperatures from -50° to 180° F
- Ozone and abrasion resistant EPDM blended cover
- 10 year warranty



Part #	Description
KTI72013	1/4" x 50' - 1/4" NPT BluBird Rubber Hose
KTI72014	3/8" x 25' - 1/4" NPT BluBird Rubber Hose
KTI72015	3/8" x 50' - 1/4" NPT BluBird Rubber Hose
KTI72016	1/2" x 50' - 1/2" NPT BluBird Rubber Hose



BluBird Rubber Air Hoses

- 100% rubber air hose
- Heavy duty, ultra light weight and super strong
- 300 PSI, NPT fittings with brass ferrules and a bend restrictor to reduce kinking
- Stays flexible in temperatures from -50° to 190° F
- Ozone and abrasion resistant EPDM blended cover
- 10 year warranty

Part #	Description
KTI72036	3/8" x 100' - 1/4" MNPT BluBird Rubber Hose
KTI72037	1/2" x 25' - 1/2" MNPT BluBird Rubber Hose
KTI72038	1/2" x 100' - 1/2" MNPT BluBird Rubber Hose
KTI72048	3/8" x 25' - 1/4" MNPT BluBird Oil Shield Air Hose
KTI72049	3/8" x 35' - 1/4" MNPT BluBird Air Hose

Rubber Air Hose

- Solid brass end MNPT fittings
- Protective PVC bend restrictor ends
- Abrasion-resistant rubber outer jacket
- 300 PSI working pressure
- 1 year warranty



Part #	Description
KTI72001	3/8" x 25' - 1/4" MNPT Rubber Air Hose - Red
KTI72002	3/8" x 50' - 1/4" MNPT Rubber Air Hose - Red
KTI72003	1/2" x 25' - 3/8" MNPT Rubber Air Hose - Red
KTI72004	1/2" x 50' - 3/8" MNPT Rubber Air Hose - Red
KTI72005	1/2" x 25' - 1/2" MNPT Rubber Air Hose - Red
KTI72006	1/2" x 50' - 1/2" MNPT Rubber Air Hose - Red
KTI72010	3/8" x 25' - 1/4" MNPT Rubber Air Hose - Yellow
KTI72011	3/8" x 35' - 1/4" MNPT Rubber Air Hose - Yellow
KTI72012	3/8" x 50' - 1/4" MNPT Rubber Air Hose - Yellow
KTI72025	3/8" x 25' - 1/4" MNPT Rubber Air Hose - Red
KTI72035	3/8" x 35' - 1/4" MNPT Rubber Air Hose - Red
KTI72050	3/8" x 50' - 1/4" MNPT Rubber Air Hose - Red





BluBird
RUBBER AIR HOSE



AIR TOOLS & ELECTRIC TOOLS



AvaGard Rubber Air Hoses, Red

- AvaGard premium 300 PSI professional rubber air hose with 1/4" NPT
- Very light, super strong and super agile
- Stays flexible in extreme conditions from -40 to 180° F
- Oil resistant core tube meets RMA Class C oil resistance and ozone resistant cover resists extreme weather, abrasions & kinks
- Ultimate durability • Color: red • 5 year warranty

Part #	Description
KT172020	AvaGard 3/8" x 25' Air Hose, Red
KT172021	AvaGard 3/8" x 50' Air Hose, Red

Part #	Description
KT172022	AvaGard 1/2" x 25' Air Hose, Red
KT172023	AvaGard 1/2" x 50' Air Hose, Red



BluBird Oil Shield Air Hose

- BluBird Oil Shield 300 PSI 100% rubber air hose
- Ultra lightweight, extreme durability resists abrasion and ultra high strength exceeds RMA IP-2
- Stays flexible in extreme conditions from -30 to 190° Fahrenheit
- Oil resistant core tube and cover meets RMA Class A oil resistance
- Four finger grip bend restrictor for easy use and better durability
- Color: Yellow
- 3 Year Warranty

Part #	Description
KT172017	3/8" x 35' - 1/4" NPT BluBird Oil Shield Air Hose
KT172018	3/8" x 50' - 1/4" NPT BluBird Oil Shield Air Hose
KT172019	1/2" x 50' - 1/2" NPT BluBird Oil Shield Air Hose
KT172039	3/8" x 100' - 1/4" MNPT BluBird Oil Shield Air Hose
KT172048	3/8" x 25' - 1/4" MNPT BluBird Oil Shield Air Hose
KT172047	1/2" x 25' - 1/2" MNPT BluBird Oil Shield Air Hose
KT172041	1/2" x 100' - 1/2" MNPT BluBird Oil Shield Air Hose



KT172042

BluBird Oil Shield 3/4" x 25' Air Hose

- BluBird Oil Shield with Dino Hide wrapping 3/4" x 25' 300 PSI 100% rubber air hose with 3/4" MNPT
- Ultra lightweight, extreme durability resists abrasion and ultra high strength exceeds RMA IP-2
- Stays flexible in extreme conditions from -30 to 190° Fahrenheit
- Oil resistant core tube and cover meets RMA Class A oil resistance
- Four finger grip bend restrictor for easy use and better durability
- Color: Yellow
- 3-Year Warranty



KT172043

BluBird Oil Shield 3/4" x 50' Air Hose

- BluBird Oil Shield with Dino Hide wrapping 3/4" x 50' 300 PSI 100% rubber air hose with 3/4" MNPT
- Ultra lightweight, extreme durability resists abrasion and ultra high strength exceeds RMA IP-2
- Stays flexible in extreme conditions from -30 to 190° Fahrenheit
- Oil resistant core tube and cover meets RMA Class A oil resistance
- Four finger grip bend restrictor for easy use and better durability
- Color: Yellow
- 3-Year Warranty





• BluBird air hoses are heavy duty, ultra light weight and super strong. Stay flexible in temperatures from -50 to 190° fahrenheit. Ozone, UV & abrasion resistant. Covered by a 10 year warranty

• BluBird Oil Shield air hoses are ultra lightweight, extreme durability resists abrasion and ultra high strength exceeds RMA IP-2. Stay flexible in extreme conditions from -30 to 190° fahrenheit. Oil resistance core tube and cover meets RMA Class A oil resistance. Covered by a 3 year warranty

KT171005

BluBird And Oil Shield Air Hose Promo Pack

Contains 8 air hoses:

- (2) - **KT172015** - BluBird 3/8" x 50'
- (2) - **KT172018** - Oil Shield 3/8" x 50'
- (1) - **KT172049** - BluBird 3/8" x 35'
- (1) - **KT172017** - Oil Shield 3/8" x 35'
- (1) - **KT172014** - BluBird 3/8" x 25'
- (1) - **KT172048** - Oil Shield 3/8" x 25'

• Size of promotional pack on display:
Width: 24", Depth: 11", Height: 26"



KT172044

BluBird Oil Shield Whip Hose 3/8" x 3'

- 1/4" FNPT
- 1/4" MNPT Ball Swivel 360 degrees
- Oil resistant core tube and cover meets RMA Class A oil resistance
- Color: Yellow • 3 Year Warranty

KT172045

BluBird Oil Shield Whip Hose 3/8" x 5'



KT172007

3/8" x 3' Whip Hose 1/4" Swivel

- Red rubber whip hose with brass ferrule
- 1/4" Swivel + 1/4" Fixed NPT Male Fittings
- 1 Year Warranty on material and workmanship • 300 PSI

KT172008

3/8" x 6' Whip Hose 1/4" Swivel

- 1 Year Warranty on material and workmanship

KT172000

Rubber Whip Hose 3/8" x 3', 1/4" NPT

- Solid brass 1/4" NPT male ends
- 300 PSI
- 1 Year Warranty on material and workmanship



KT172009

BluBird Whip Hose 3/8" x 3', 1/4" FNPT

- 1/4" FNPT
- 1/4" MNPT Ball Swivel 360°
- Ozone, UV & abrasion resistant
- Color: Blue
- 10-Year Warranty



AIR TOOLS & ELECTRIC TOOLS



KT172046 BluBird Whip Hose 3/8" x 5', 1/4" FNPT

- 1/4" FNPT
- 1/4" MNPT Ball Swivel 360°
- Ozone, UV and abrasion resistant
- Color: Blue
- Covered by a 10-Year Warranty

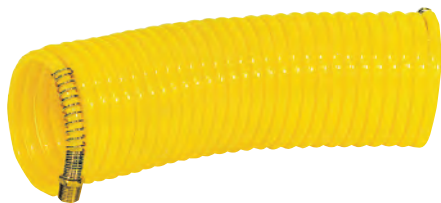

LIFETIME WARRANTY*

KT171025 Nylon Recoil Hose

These K-Tool International nylon recoil air hoses will provide your air-operated tools with consistent airflow. They are manufactured from heavy-duty nylon to perform great in all weather conditions. Extends out to 25 ft., but as small as 2 ft. when coiled up.

KT171000 Black Steel Hose Reel With 3/8" x 50 Foot Rubber Air Hose

- All steel constructed black reel with 300 PSI red rubber hose (50 foot)
- Slotted mounting base for easy installation
- Automatic spring powered recoil
- 8 position ratchet gear locks reel at desired hose length
- 3/8" I.D., 1/4" male NPT
- 1 year warranty on material and workmanship



Heavy duty, steel construction air hose reel. Reinforced side plates are powder coated to resist corrosion. Comes with 3/8" diameter, 50 ft. rubber air hose which features a 1/4" male NPT, PVC bend restrictor, and brass ferrule. The eight position ratchet gear locks the reel at desired hose length. An automatic spring powered recoil system retracts air hose easily. Multi-direction rollers prevent snagging and reduced wear. The pre-slotted base can be installed trouble-free with 3 positions for installation where convenient (bench, ceiling, floor or wall).



BluBird Air Hose Reels

- 300 PSI retractable rubber air hose reel with lead in hose and 1/4" NPT fittings
- Smooth auto-rewind with locking 12 point ratchet gearing system which helps to lock at various lengths
- Heavy duty steel construction with powder coated, corrosion proof finish
- Four rollers reduce hose wear
- Horizontal and vertical wall mount options with adjustable guide arm
- 2 Year warranty

KT171001 - 3/8" x 50' BlueBird Air Hose

KT171002 - 1/2" x 50' BlueBird Air Hose



KT171003 BluBird HD Air Hose Reel 3/8" x 50'

- BluBird Oil Shield 3/8" x 50' 300 PSI Heavy Duty retractable rubber air hose reel with 3' lead in hose and 1/4" NPT fittings
- Smooth auto-rewind with locking 12 point ratchet gearing system which helps to lock at various lengths
- Heavy duty steel construction with powder coated, corrosion proof finish
- Four rollers reduce hose wear
- Horizontal and vertical wall mount options with adjustable guide arm

2-Year Warranty on Reel with 3-Year Warranty on the included yellow Oil Shield hose.



KT110010
4-1/2" Angle Grinder
650 Watt

- Features a compact design for improved handling
- Spindle lock makes changing the grinder wheel quick and easy
- Grinder also includes a grinding wheel guard, wrench and flange
- Ergonomic, removable side handle adds versatility for any job
- UL listed; One-year limited warranty.

Specifications: 5 amp; 11,000 rpm no-load speed; 120 volt AC rating. A spindle lock makes changing the grinder wheel quick and easy. Grinder also includes a grinding wheel guard, wrench and flange. The ergonomic, removable side handle adds versatility for any job!



KT110210
10" Random Orbit Polisher/Waxer

- 10-inch pad to reduce waxing and polishing time
- For use on cars, RVs, vans, SUVs and boats
- High-impact ABS shell for added durability
- Includes one (1) terry cloth bonnet and one (1) synthetic wool bonnet
- UL listed
- One-year limited warranty

Polisher maintains that "new car finish" and protects and restores older finishes. Specifications: 0.75 amp; 3,000 rpm no load speed; 120V/60Hz rated voltage; 10-inch cord.



KT181380
1/2" Electric Impact Wrench

- 7 amp tool features 120 volts, 2100 RPM and double insulation
- Up to 235 ft./lbs. of torque
- Complete with an extra set of easy-change screw in brushes
- 1 Year Warranty on material and workmanship

This heavy-duty 7 amp tool features 120V, 2100 rpm, double insulation and up to 235 ft./lbs. of torque. Packaged with an extra set of easy change screw-in brushes.

Warranty: Repairable up to 1 year



KT110215
7" Variable Speed Polisher

- 7" Pad
- Variable speeds: 1,000 to 3,000 rpm
- Soft start
- Overload protection and trigger lock
- UL listed
- One-year limited warranty

The electric 7" polisher/sander features variable speed control which allows users to set maximum speeds from 1,000 to 3,000rpm for different polishing applications. Polisher boasts a repositionable handle for a variety of jobs. Specifications: 11 amp; 120V/60Hz; variable speeds: 1,000 to 3,000 rpm; soft start; overload protection and trigger lock.

Includes: one (1) 7" rubber polishing pad; one (1) 7" sanding pad and one (1) wool bonnet.



SHOP TOOLS



1.800.762.6002 | www.ktoolinternational.com

Shop Tools | Lifting

KTI63201 2 Ton Bottle Jack

- Capacity: 2 Tons
- Lifting Range: 6.2" to 12.1"
- Ram extension screw adjusts low height to get full use of ram travel
- Load-limiting and bypass valves prevent against over loading and over extension
- Ductile iron hydraulic base for added strength
- 1 Year Warranty on material and workmanship
- Complies With ASME PASE/2014 Safety Standards



KTI63207 6 Ton Bottle Jack

- Capacity: 6 Tons
- Lifting Range: 7.75" - 15.04"
- Ram extension screw adjusts low height to get full use of ram travel
- Load-limiting and bypass valves prevent against over loading and over extension
- Ductile iron hydraulic base for added strength
- 1 Year Warranty on material and workmanship
- Complies With ASME PASE/2014 Safety Standards



XD Bottle Jacks

- Ram extension screw adjusts low height to get full use of ram travel
- Load-limiting and bypass valves prevent against over loading and over extension
- Ductile iron hydraulic base for added strength
- 2 Year Warranty on material and workmanship
- Complies With ASME PASE/2014 Safety Standards

KTI63213 Capacity: 12 Tons, Lifting Range: 8.46" - 15.75"

KTI63221 Capacity: 20 Tons, Lifting Range: 9.6" - 16.65"



Short X-D Bottle Jacks

- Ram extension screw adjusts low height to get full use of ram travel
- Load-limiting and bypass valves prevent against over loading and over extension
- Ductile iron hydraulic base for added strength
- 2 Year Warranty on material and workmanship
- Complies With ASME PASE/2014 Safety Standards

KTI63214 Capacity: 12 Tons, Lifting Range: 7.48" - 13.78"

KTI63224 Capacity: 20 Tons, Lifting Range: 7.25" - 13.39"



KTI63230 30 Ton Bottle Jack

- 30 ton bottle jack with lift range from 11.2" to 18.27"
- Thick steel hydraulic base for maximum strength
- Three-piece snap-fit pump handle for easy pumping and storage
- Carrying handle included
- Load-limiting and bypass valves prevent against over loading and over extension of ram
- 2 Year Warranty on material and workmanship
- Complies With ASME PASE/2014 Safety Standards



KTI63250 50 Ton Bottle Jack

- 50 ton bottle jack with lift range from 11.8" to 18.8"
- Thick steel hydraulic base for maximum strength
- Three-piece snap-fit pump handle for easy pumping and storage
- Carrying handle included
- Load-limiting and bypass valves prevent against over loading and over extension of ram
- 2 Year Warranty on material and workmanship
- Complies With ASME PASE/2014 Safety Standards



KTI63228

20 Ton Air Hydraulic Bottle Jack

- Lifting Range: 10.43" - 19.88"
- Air/hydraulic pump with air valve lever reduces lifting time and provides ease of operation
- Load limiting and bypass valves prevent use beyond rated capacity and over extension of ram
- Additional adjustable screw 3.25"
- 2 Year Warranty on material and workmanship
- Complies With ASME PASE/2014 Safety Standards



KTI63100

1.5 Ton Scissor Jack

- For tire changing and snow chain installation
- Lifting range from 4.1" to 15.2"
- Large base for added stability
- Long crank handle for ease of turning under load
- All steel construction in a compact design for storage
- 1 Year Warranty on material and workmanship
- Complies With ASME PASE/2014 Safety Standards

KTI63103

2 Ton Trolley Jack

- Lifting Capacity: 2 Tons
- Lifting Range: 5.3" to 13.2"
- Lightweight and compact design for easy handling and storage
- Load-limiting and bypass valves prevent against over loading and over extension
- Grab handle for easy positioning and carrying
- 1 Year Warranty on material and workmanship
- Complies With ASME PASE/2014 Safety Standards



KTI63131

3 Ton

Compact Service Jack

- Capacity: 3 Tons
- Lifting range: 5.3" - 18.5"
- Sealed hydraulic power unit prevents contaminants from entering system
- Load-limiting and bypass valves prevent use beyond rated capacity and over extension of ram
- Wide track front wheels and rear swivel casters for easy maneuverability
- 1 Year Warranty on material and workmanship
- Complies With ASME PASE/2014 Safety Standards



KTI63098

2 Ton Aluminum Service Jack

- Very strong, 2 ton capacity, but weights only 42.1 lbs. ASME PALD 2009
- Dual pump system for quick lifting (7 strokes to top under no load)
- Lifting range 3 1/4" - 18 1/2"
- Side handle for easy positioning
- 2 pc handle for easy storage. Includes handle pad for protecting the vehicle
- 2 Year Warranty
- Complies With ASME PASE/2014 Safety Standards



KTI63099

3 Ton Aluminum Service Jack

- Very strong, 3 ton capacity, but only weights 55.8 lbs. ASME PALD 2009
- Dual pump system for quick lifting (7 strokes to top under no load)
- Lifting range 3 3/4" - 19 1/4"
- "D" Side handle for easy positioning
- 2 piece handle for easy storage. Includes handle pad for protecting the vehicle
- 2 Year warranty
- Complies With ASME PASE/2014 Safety Standards



KTI63101

2 Ton Low Profile Service Jack

- Allows for easy access under low ground clearance vehicles
- Lift range from 3.5" to 18.1"
- 45.25" long pump handle for easy pumping under load
- Dual pump piston power unit raises saddle to maximum height in 6.5" full incremental pump strokes with no load
- Load-limiting and bypass valves to prevent use beyond rated capacity and over-extension of ram
- Saddle diameter 4.3"
- 2 Year Warranty on material and workmanship
- Complies With ASME PASE/2014 Safety Standards



KTI63133

3.33 Ton Low Profile Service Jack

- 3.33 ton capacity low profile service jack for easy access under low ground clearance vehicles
- Lift range from 3.5" to 21.375"
- 50" long pump handle for easy pumping under load
- Dual pump piston power unit raises saddle to maximum height in 8 full incremental pump strokes with no load
- Load-limiting and bypass valves to prevent use beyond rated capacity and over-extension of ram
- 2 Year Warranty on material and workmanship
- Complies With ASME PASE/2014 Safety Standards



KTI63105

2 Ton Extra Long Low Profile Service Jack

- Allows for easy access under low ground clearance vehicles
- Lift range from 2.75" to 24" • Saddle diameter 3.85"
- 45.25" long pump handle for easy pumping under load
- Dual pump piston power unit raises saddle to maximum height in 8 full incremental pump strokes with no load
- Load-limiting and bypass valves to prevent use beyond rated capacity and over-extension of ram
- 2 Year Warranty on material and workmanship
- Complies With ASME PASE/2014 Safety Standards



KTI63155

5 Ton Service Jack

- 5 ton capacity service jack with a lift range from 5.75" to 22"
- 45.75" long pump handle with release knob works independently of handle position
- Raise the saddle quickly to the load with additional foot pedal
- Load-limiting and bypass valves prevent jack from being used beyond rated capacity and over-extension of ram
- Handle locks in either vertical, 45°, or horizontal positions
- 2 Year Warranty on material and workmanship
- Complies With ASME PASE/2014 Safety Standards

KTI63186

10 Ton Service Jack

- 10 ton capacity service jack with a lift range from 6.25" to 22.5"
- 45.75" long pump handle with release knob works independently of handle position
- Raise the saddle quickly to the load with additional foot pedal
- Load-limiting and bypass valves prevent jack from being used beyond rated capacity and over-extension of ram
- Handle locks in either vertical, 45°, or horizontal positions
- 2 Year Warranty on material and workmanship
- Complies With ASME PASE/2014 Safety Standards





KTI63194

22 Ton Air Hydraulic Truck Jack

- 22 ton capacity truck jack with a lift range from 9.06" to 17.94"
- Narrow width fits between tandem wheels
- Load-limiting and bypass valves prevent use beyond rated capacity and overextension of ram
- Spring activated self retracting ram
- Release knob at the top of the T-handle works at any handle position
- 2 Year Warranty on material and workmanship
- Complies With ASME PASE/2014 Safety Standards



KTI63198

50 Ton Air Hydraulic Truck Jack

- 50 ton capacity truck jack with lift range from 11.4" to 21.25"
- Narrow width fits between tandem wheels
- Load-limiting and bypass valves prevent use beyond rated capacity and over-extension of ram
- Spring activated self-retracting ram
- Release knob at top of T handle works at any handle position
- 2 Year Warranty on material and workmanship
- Complies With ASME PASE/2014 Safety Standards



KTI63194COMBO

22 Ton Air Hydraulic Jack w/1" Air Impact

- A combination package including a 22 ton capacity truck jack (KTI63194) with a lift range from 9.06" to 17.94" and a 1" drive air impact wrench with 6" extended anvil (KTI81798A)
- The air hydraulic jack has load-limiting and bypass valves which prevent use beyond rated capacity and overextension of ram with spring activated self retracting ram. Has release knob at the top of the T handle works at any handle position and narrow width fits between tandem wheels
- The air impact wrench has a 6" extended anvil for extra access, 1,600 ft/lbs of torque, 3 forward and 3 reverse power settings, a D side handle for ease of use and side exhaust which directs air away from the job
- The hydraulic jack complies with ASME PASE/2014 Safety Standards and is covered by a 2 year warranty on material and workmanship
- The 1" air impact wrench is covered by a 1 year warranty



SERVICE JACKS SPECIFICATIONS						
Supplier	Part #	Capacity (tons)	Minimum Height	Maximum Height	Air Assist	Special Features
K Tool	KTI63103	2	3.5"	18.1"	N	Low Profile
K Tool	KTI63098	2	3.25"	18.5"	N	Aluminum
K Tool XD	KTI63101	2	3.5"	18.1"	N	Low Profile
K Tool XD	KTI63105	2	2.75"	24"	N	Extra Long, Low Profile
K Tool	KTI63131	3	5.3"	18.5"	N	Compact
K Tool	KTI63099	3	3.75"	19.25"	N	Aluminum
K Tool XD	KTI63133	3.33	3.5"	21.375"	N	Low Profile
K Tool HD	KTI63155	5	5.75"	22"	N	Heavy Duty
K Tool HD	KTI63186	10	6.25"	22.5"	N	Heavy Duty

KTI63500
700 lb Pedestal
Transmission Jack

- Capacity: 700 lbs.
- Hand pumped, long stroke, single stage bottle jack, with a release lever to discharge the load
- Load-limiting and bypass valves prevent against over loading and over extension
- Adaptable saddle, with four angle brackets that can adjust to fit transmission pan flanges
- Adjustable safety chain included to aid in load restraint
- 1 Year Warranty on material and workmanship
- Complies With ASME PASE/2014 Safety Standards



KTI63502
1000 Lb Single Stage
Transmission Jack

- Capacity: 1,000 lbs.
- Lifting Range: 43.625" - 71"
- Saddle tilt: 23 degrees forward and 16 degrees backward
- For automotive use up to light duty pickup trucks
- Foot pedal activation easily raises single ram under load
- 2 Year Warranty on material and workmanship
- Complies With ASME PASE/2014 Safety Standards



KTI63505
1000 Lb. 2-Stage Telescopic
Transmission Jack

- Capacity: 1,000 Lbs
- Lifting Range: 35" to 74.2"
- Speedy pump foot pedal raises telescopic rams to load quickly
- Foot pump and release pedals provide hands free operation to align saddle with transmission
- Four caster wheels for easy transportation and maneuverability
- 2 Year Warranty on material and workmanship
- Complies With ASME PASE/2014 Safety Standards



KTOOL INTERNATIONAL **XD**



KTI63515
1200 Lb Low Profile
Transmission Jack

- 1200 pound capacity transmission jack with a lift range from 5.75" to 31.5"
- For automotive use up to pickup truck transmissions
- Wide front-open chassis for lower profile when loaded
- Full swivel pump handle can be accessed in any work position
- Fully adjustable universal saddle with load securing hardware
- 2 Year Warranty on material and workmanship
- Complies With ASME PASE/2014 Safety Standards

KTOOL INTERNATIONAL **HD**



KTI63517
1.5 Ton Truck Transmission Jack

- 1.5 ton capacity truck transmission jack with lift range from 8.62" to 36.625"
- Front and back swivel casters allow for trouble-free positioning and maneuverability
- Pump handle rotates 360° for multiple work positions
- Universal saddle with tilt features
- Load restraint system included
- 2 Year Warranty on material and workmanship
- Complies With ASME PASE/2014 Safety Standards

KTOOL INTERNATIONAL **XD**



KTI63134
Transmission Jack
Adapter for Service Jacks

- Capacity: 700 lbs
- Saddle Forward Tilt: 35°
- Saddle Backward Tilt: 35°
- Designed for jacks with a slip in saddle
- Easily transforms your service jack into a transmission jack; fits KTI63131 - 3 Ton Compact Service Jack
- Weight: 34.5 lbs
- 2 Year Warranty on material and workmanship
- Complies With ASME PASE/2014 Safety Standards

KTOOL INTERNATIONAL **XD**



KTI63136
Fuel Tank Adapter

- Quick and easy installation to all underhoist transmission jack saddles
- Universal adapter plate included for mounting to all other under hoist jack saddles
- Length, width, and height adjustments to handle any fuel tank configuration up to 40 gallon capacity
- Four 3" by 5.5" foam support pads self adjust and protect the tank from damage
- Ground wire assembly can be used with older metal tanks to prevent against static electric discharge
- 2 Year Warranty on material and workmanship
- Complies With ASME PASE/2014 Safety Standards



Jack Stands

- Designed to be used in pairs
- Steel base with four feet pads for stability
- Ratchet action design with ductile iron support column
- 2 Year Warranty on material and workmanship
- Complies With ASME PASE/2014 Safety Standards

KTI61202 3 Ton Jack Stands, Lifting Range: 11.6" to 16.7"

KTI61205 6 Ton Jack Stands, Lifting Range: 15.75" to 24"



KTI61211 12 Ton Jack Stands

- Capacity: 12 Tons
- Lifting Range: 19.63" to 30.25"
- Steel square base with foot pads for added strength and stability
- Ductile iron column supports load off the ground
- Weight: 52.9 lbs
- 2 Year Warranty on material and workmanship
- Complies With ASME PASE/2014 Safety Standards

JACK STANDS SPECIFICATIONS

Supplier	Part #	Capacity	Minimum Height	Maximum Height	Style
K Tool HD	KTI61222	22 Ton	11-7/8"	19-3/4"	Pin Style
K Tool XD	KTI61202	3 Ton	11-3/4"	16-3/4"	Ratchet
K Tool XD	KTI61205	6 Ton	15-3/4"	24"	Ratchet
K Tool XD	KTI61211	12 Ton	19-5/8"	30-1/4"	Ratchet

KTI61222 22 Ton Jack Stands

- Pair of 22 ton capacity pin type jack stands with support range from 11.825" to 19.75"
- Height adjustment pin connected to base by way of lanyard to prevent against loss
- Steel plate and structural tubing for added strength and stability
- V-shaped saddle to cradle axles and other truck components
- Sold and to be used in pairs
- 2 Year Warranty on material and workmanship
- Complies With ASME PASE/2014 Safety Standards



SHOP TOOLS



KT161076 3/4 Ton Utility Underhoist Stand

- 3/4 ton under hoist stand designed to support under car components
- Support range from 53" to 79"
- Acme threaded screw for self-locking positioning
- Bearing mounted spin handle for easy raising and lowering of screw
- 12" diameter base with 1.63" x 5.5" saddle provide additional support
- 2 Year Warranty on material and workmanship
- Complies With ASME PASE/2014 Safety Standards



KT161077 3/4 Ton Utility Underhoist Stand with Pedal

- 3/4 ton under hoist stand designed to support under car components
- Support range from 53" to 79"
- Acme threaded screw for self-locking positioning and foot pedal to raise screw another 1.25" under 400 pounds of load
- Bearing mounted spin handle for easy raising and lowering of screw
- 12" diameter base with 1.63" x 5.5" saddle provide additional support
- 2 Year Warranty on material and workmanship
- Complies With ASME PASE/2014 Safety Standards



KT161002 2 Ton Tripod Underhoist Stand

- 2 ton under hoist stand designed to help stabilize a vehicle suspended by an above-ground lift
- Support range from 68" to 76"
- Acme threaded screw for 8" of fine adjustment
- Bearing mounted spin handle for easy raising and lowering of screw
- 24" triangle shaped base and 3.25" square saddle provide additional stability
- 2 Year Warranty on material and workmanship
- Complies With ASME PASE/2014 Safety Standards



KTOOL XD
INTERNATIONAL



KTi62108
800 Lb. H-Style Engine Stand

- Capacity: 800 lbs
- H-frame design base with four wheels provides stability
- Stand made of structural steel tubing for strength and light enough for easy maneuverability
- Fully adjustable mounting head and adapter fingers
- Weight: 49.8 lbs
- 2 Year Warranty on material and workmanship
- Complies With ASME PASE/2014 Safety Standards

KTOOL XD
INTERNATIONAL

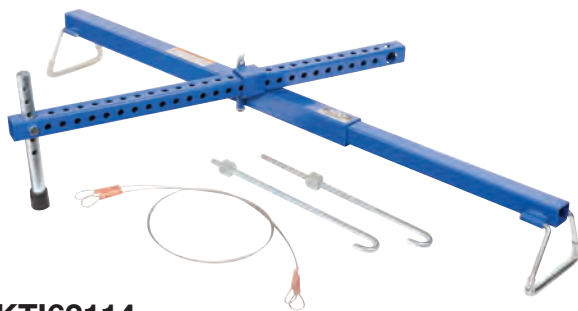

KTi62114
700 Lb Engine Support Bar

- Transverse support bar adjusts from 34.5" to 61"
- Designed to support front wheel drive engines for repair or motor mount replacement
- Includes support leg for heavier engines or engines requiring three point support
- Engine attachment and adjustment hardware provided
- 2 Year Warranty on material and workmanship
- Complies With ASME PASE/2014 Safety Standards

KTOOL XD
INTERNATIONAL



SHIPPED
FREIGHT

KTi62110
1000 Lb Geared Engine Stand

- 1000 pound capacity foldable engine stand for convenient storage when not in use
- Worm gear driven mounting plate with adjustable fingers rotates for desired engine position
- Four wheel design with locking caster wheels to prevent stand from moving
- Made of structural steel plate and tubing for added strength
- Weighs 96 lbs
- 2 Year Warranty on material and workmanship
- Complies With ASME PASE/2014 Safety Standards

KTOOL HD
INTERNATIONAL



KTi62116
1000 Lb Engine Support Bar

- Designed to support front wheel drive engines for repairs or servicing of engine mounts
- Includes a 1000 pound capacity transverse bar that extends from 34.5" to 61"
- Includes a support leg for handling larger engines or engines requiring three support points
- Engine attachment and adjustment hardware included
- Weight 41.9 lbs
- 2 Year Warranty on material and workmanship
- Complies With ASME PASE/2014 Safety Standards



KTi62115 1500 Lb. Engine Sling

- 1500 pound capacity engine sling for use with an engine crane
- Designed to level a load or adjust at a specific angle for installation and removal
- Hand crank and bearing mounted drive screw for easy adjustment
- Four mounting chains and brackets for quick attachment to engine
- Weighs 14.3 lbs
- 2 Year Warranty on material and workmanship
- Complies With ASME PASE/2014 Safety Standards



KTi63414 4 Ton Long Ram

- 4 ton long ram bottle jack for farm applications and replacement power unit for engine cranes
- Lift range from 19.7" to 34.7".
- * Release valve slowly controls the lowering of load
- Load-limiting and bypass valves to prevent overloading and over extension of ram
- Long handle for easy pumping effort under load
- Hole in top of ram for receiving mounting bolt
- 2 Year Warranty on material and workmanship
- Complies With ASME PASE/2014 Safety Standards



KTi63427 8 Ton Long Ram

- 8 ton long ram bottle jack for farm applications and replacement power unit for engine cranes
- Lift range from 24" to 42.7".
- * Release valve slowly controls the lowering of load
- Load-limiting and bypass valves to prevent overloading and over extension of ram
- Long handle for easy pumping effort under load
- Hole in top of ram for receiving mounting bolt
- 2 Year Warranty on material and workmanship
- Complies With ASME PASE/2014 Safety Standards



KTi63421 1.5 Ton Foldable Engine Crane with Fast Rise

- 750 Lbs. / 1,500 Lbs. / 2,250 Lbs. / 3,000 Lbs. capacity engine crane with four different boom positions
- Legs and boom fold quickly for storage
- Fast rise pump without a load
- 48" long boom with chain and swivel hook included
- 4.25" low profile base for easy access under low ground clearance vehicles
- 2 Year Warranty on material and workmanship
- Complies With ASME PASE/2014 Safety Standards



KTI63703

4 Ton Portable Ram Kit

- 4 ton portable ram kit for spreading, bending, pushing, and clamping applications
- 7,250 PSI hand pump and 10.5" long ram with 4.75" stroke
- Basic attachments, .5 ton spreader ram, and five extension tubes included
- Force gauge to measure force applied to work
- Snap-fit design for quick attachment and tube connections
- 2 Year Warranty on material and workmanship
- Complies With ASME PASE/2014 Safety Standards



KTI63709

10 Ton Portable Ram Kit

- 10 ton portable ram kit for spreading, bending, pushing, and clamping applications
- 8,050 PSI hand pump and 12.6" long ram with 5.12" stroke
- Basic attachments, .5 ton spreader ram, and four extension tubes included
- Force gauge to measure force applied to work
- Snap-fit design for quick attachment and tube connections
- 2 Year Warranty on material and workmanship
- Complies With ASME PASE/2014 Safety Standards



KTI63716

Air Hydraulic Foot Pump

- 10,000 PSI air/hydraulic foot pump requires 90 PSI air pressure
- Designed to be used with single acting cylinders
- Provides hands free operation for pumping and releasing load
- Usable fluid capacity 98 cubic inches
- Flow rate 42 cu. in. with no load, 8.5 cu. in. with load
- 2 Year Warranty on material and workmanship
- Complies With ASME PASE/2014 Safety Standards





KTI63611 12 Ton Shop Press

- 12 ton capacity shop press made of structural steel channel for added strength
- Pump, 7.1" stroke self-retracting ram and hose with glycerine filled gauge
- Vertical throat opening between 0" to 36.5", 17.75" throat width
- 3.375" opening between movable bolster channels
- 53" frame height, 21.5" width, and 27.5" base leg length
- 2 Year Warranty on material and workmanship
- Complies With ASME PASE/2014 Safety Standards



KTI63619 20 Ton Shop Press

- 20 ton capacity shop press made of structural steel channel for added strength
- Pump, 7.28" stroke self-retracting ram and hose with glycerine filled gauge
- Vertical throat opening between 0" to 38", 21.25" throat width
- 4.25" opening between movable bolster channels
- 59.5" frame height, 25.25" width, and 27.5" base leg length
- 2 Year Warranty on material and workmanship
- Complies with ASME PASE/2014 Safety Standards

KTI60060 Heavy-Duty 6" Bench Grinder

- 1/3 HP, 115 volt with 3450 RPM no load speed
- Cast iron motor housing for heavy duty applications and long life
- Two grinding wheels (1 course 36-grit and 1 wire for grinding and sharpening)
- Two adjustable tool rests to accommodate a variety of uses and provide additional stability for precision grinding
- Fully adjustable acrylic eye shields deflect sparks away from operator for added safety
- UL listed
- Warranty information: 1-year limited warranty



Shop Tools | Creepers, Stools & Fender Covers

Metal Frame Creeper with Rubber Casters

- Metal frame creeper features a fully padded seat for comfort
- Rugged, durable construction for a lifetime of use
- Six (6) 2-inch oil-resistant rubber casters provide smooth mobility
- Steel frame is epoxy-coated to prevent rusting
- Four (4) cross rails provide added support
- Assembly required

Warranty information: 90-day limited warranty.

KTI74951 - 36"
KTI74956 - 40"

Replacement parts:
KTI74959 - replacement caster



KTI74961

40" Metal Frame Creeper with Adjustable Headrest

- KTI 40" metal frame creeper features a fully padded seat for comfort
- Adjustable headrest is comfortable and convenient for every use
 - Rugged, durable construction for a lifetime of use
 - Six (6) 2-inch oil-resistant rubber casters provide smooth mobility
 - Steel frame is epoxy-coated to prevent rusting
 - Four (4) cross rails provide added support
 - Assembly required

Warranty information: 90-day limited warranty.

Replacement parts:
KTI74959 - replacement caster



KTI74971 Padded Mechanic's Creeper Seat with Pneumatic Lift

- Adjustable mechanic's seat features fully padded 12" seat for added comfort
- Seat is adjustable by pneumatic cylinder from 14" to 19"
- Large steel base also serves as storage for tools while working
- Features five (5) 2-1/2" oil-resistant rubber casters for smooth mobility
- Assembly required

Warranty information: 90-day limited warranty.

Replacement parts:
KTI74957 - replacement caster



KTI74981 Padded Mechanic's Creeper Seat with Storage Tray

- Mechanic's seat with plastic storage tray
- Fully padded seat measures 7" x 14"
- Plastic tray has three sections to store tools or small parts
- Features four (4) 2-1/2" oil-resistant rubber casters for smooth mobility
- Metal frame is epoxy-coated to prevent rusting
- Assembly required

Warranty information: 90-day limited warranty.

Replacement parts:
KTI74958 - replacement caster



Deluxe Fender Cover

Vinyl-backed foam cover is designed to protect/cover fenders to avoid scratching, marring or damaging vehicle finish. Available in black or red.

Sold separately:
KTI73201 - Black
KTI73202 - Red



Shop Tools | Material Handling



KTI63820 1250 Lb Capacity Car Dollies

- Pair of 1250 pound capacity car dollies used to move a disabled vehicle
- Made of steel structural tubing for durability
- Four bearing mounted swivel caster wheels for easy maneuverability
- Two locking caster wheels on each dolly to prevent vehicle from moving
- Weight: 49 lbs
- 2 Year Warranty on material and workmanship
- Complies With ASME PASE/2014 Safety Standards

KTI63800 Hand Pallet Jack

High quality welded steel construction and powder-coated finish.

- Capacity: 6500 lbs.
- Max lift height: 7"
- Lowered fork height: 3"
- Fork width: 27"
- Fork length: 48"
- Turning radius: 210°
- Weight: 187 lbs.

Warranty information:
1-year warranty. Repair or replace at discretion of repair center.

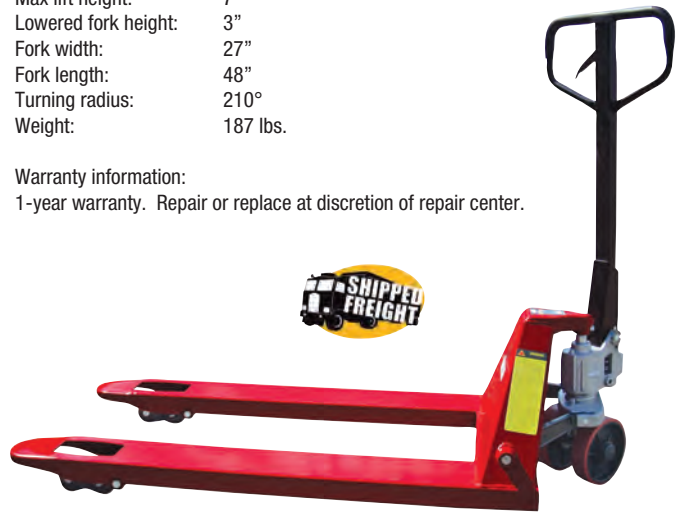

Tow Straps

Heavy-duty nylon web construction with reinforced stitching. Available with looped end or forged hooks. Abrasion and cut resistant. Strongest, longest-lasting webbing tow straps on the market. Meet or exceed all DOT specifications.

Part #	Type of Ends	Capacity	Width	Length
KTI73801	Forged hooks	7,000 lb. capacity	2" width	10' length
KTI73802	Forged hooks	10,000 lb. capacity	2" width	15' length
KTI73803	Forged hooks	10,000 lb. capacity	2" width	25' length

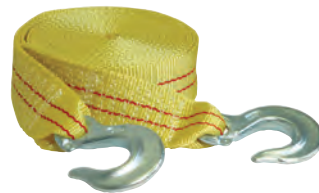

Heavy-duty Tow Straps

Heavy duty nylon web construction with reinforced stitching and looped ends. Abrasion and cut resistant. Strongest, longest-lasting webbing tow straps on the market. Meet or exceed all DOT specifications.

Part	Type of Ends	Capacity	Width	Length
KTI73810	Looped ends	15,000 lb. capacity	2" width	20' length
KTI73811	Looped ends	22,500 lb. capacity	3" width	20' length
KTI73812	Looped ends	30,000 lb. capacity	3" width	30' length
KTI73813	Looped ends	40,000 lb. capacity	4" width	30' length
KTI73814	Looped ends	60,000 lb. capacity	6" width	30' length



Shop Tools | Material Handling

Recovery Tow Rope

High strength to weight ratio provides maximum pulling strength, and still allows for easy handling. Covered by a 1 year warranty.

- Double braided nylon rope is extremely strong and flexible
- Durable, UV resistant waterproof polymer coating is soaked deep into the rope fibers
- High elasticity is ideal for off-road recovery and snatching applications
- Rubber coated eye tips provide extra protection and maximum grip

Part #	Size	Eye Color	Capacity
KT173818	1/2" x 20'	Yellow	Rating: 7,400 lbs.
KT173819	3/4" x 20'	Black	Rating: 19,000 lbs.
KT173822	7/8" x 20'	Blue	Rating: 28,600 lbs.
KT173823	7/8" x 30'	Red	Rating: 28,600 lbs.
KT173824	1-1/4" x 30'	Orange	Rating: 52,300 lbs.
KT173825	1-1/2" x 30'	Green	Rating: 74,000 lbs.



Stretch Cords

Braided cover prevents abrasions and provides added durability. Vinyl covered hooks prevents scratches. Designed for professional use.



Part #	Description	Diameter	Length	Color	Qty
KT173830	General purpose	3/8" diameter	18" length	Yellow	10-pack
KT173831	General purpose	3/8" diameter	24" length	Yellow	10-pack
KT173832	General purpose	3/8" diameter	30" length	Yellow	10-pack
KT173833	General purpose	13/32" diameter	40" length	Yellow	10-pack
KT173834	General purpose	13/32" diameter	48" length	Yellow	10-pack

RUBBER STRAPS					
Part #	Description	Width	Length	Max. Stretch	Qty
KT173849	EPDM Rubber Strap	3/8" wide	15" length	22" max stretch	10-pack
KT173850	EPDM Rubber Strap	3/8" wide	21" length	31" max stretch	10-pack
KT173851	EPDM Rubber Strap	3/8" wide	31" length	46" max stretch	10-pack



TIE DOWNS & STRAPS

Part #	Description	Capacity	Width	Length	Qty
KTI73862	Ratcheting Tie Down (endless loop)	900 lb.	1" width	13' length	1-pack
KTI73861	Ratcheting Tie Down (PVC-coated hooks)	900 lb.	1" width	15' length	1-pack
KTI73870	Ratcheting Tie Down (PVC-coated hooks) (each)	900 lb.	1" width	15' length	4-pack
KTI73864	Motorcycle Tie Down (1 chrome and 1 PVC-coated hook)	1,200 lb.	1" width	6' length	1-pack
KTI73871	Universal Tie Down (PVC-coated hooks)	900 lb.	1" width	10' length	1-pack
KTI73873	Cam Buckle Tie Down (Cam buckles)	900 lb.	1" width	13' length	1-pack

K-Tool International recommends that the working load never exceed 1/3 of the rated capacity. Any strap assembly is only as strong as its weakest component, including the point of attachment or anchor.



KTI73862



KTI73861



KTI73870



KTI73864



KTI73871



KTI73873

Nylon Cable Ties

Hundreds of uses, including electrical, auto, marine, home and garden. Available in black or natural. Many sizes for a variety of applications. Professional quality. Temperature rating: 185° F (85° C).



Part #	Length	Bundle Diameter	Tensile Strength	Color	Qty
KTI76040	4"	7/8"	18 lb.	Natural	100
KTI78040	4"	7/8"	18 lb.	Black	100
KTI76070	7"	1-7/8"	50 lb.	Natural	100
KTI78070	7"	1-7/8"	50 lb.	Black	100
KTI77070	7" with mounting head	1-7/8"	50 lb.	Natural	100
KTI76110	11"	31/16"	50 lb.	Natural	100
KTI78110	11"	31/16"	50 lb.	Black	100
KTI76140	14"	4"	50 lb.	Natural	100
KTI78140	14"	4"	50 lb.	Black	100
KTI77140	14" with mounting head	4"	50 lb.	Natural	100
KTI76145	14" heavy-duty	41/16"	120 lb.	Natural	100
KTI78145	14" heavy-duty	41/16"	120 lb.	Black	100
KTI76180	18" heavy-duty	51/4"	120 lb.	Natural	25
KTI78180	18" heavy-duty	51/4"	120 lb.	Black	25
KTI76240	24" heavy-duty	73/16"	175 lb.	Natural	25
KTI78240	24" heavy-duty	73/16"	175 lb.	Black	25
KTI76360	36" heavy-duty	11"	175 lb.	Natural	25
KTI78360	36" heavy-duty	11"	175 lb.	Black	25

Shop Tools | Material Handling



Nylon Cable Tie Assortments

Convenient dispenser type package allows access to each compartment separately. Hundreds of uses, including electrical, auto, marine, home and garden. Available in black or natural. Many sizes for a variety of applications. Professional quality.

KTI76004 (Natural)
KTI78004 (Black)



Each package includes 4" (qty: 200), 7" (qty: 100) and 11" (qty: 100).



KTI76000 Nylon Tie Tightening Tool

Grips nylon cable ties and tightens with very secure grip. Also cuts excess with thumb lever.

LIFETIME WARRANTY*

Shop Tools | Heating, Welding, Soldering

KTI00035 85 Piece Shrink Tube Kit

- Multi-compartment plastic storage case
- Includes wide range of product
- Contains product assortment map
- Includes most popular sizes



This 85-piece kit contains shrink tubes in most popular sizes: 1/8" Shrink Tube, 3/16" Shrink Tube, 1/4" Shrink Tube, 3/8" Shrink Tube, 1/2" Shrink Tube.



KTI07740 235-piece Heat Shrink Tube Kit

Assortment includes eight different sizes in five colors, ranging in width from 3/32" to 3/4" and 6" in length.

Size: 1/8"	Qty:	Size: 1/4"	Qty:	Size: 5/8"	Qty:
Blue.....	11	Blue.....	11	Blue.....	1
Black.....	11	Black.....	11	Black.....	1
Orange.....	11	Orange.....	11	Orange.....	1
Green.....	11	Green.....	11	Green.....	1
Yellow.....	11	Yellow.....	11	Yellow.....	1
Size: 3/32"	Qty:	Size: 3/8"	Qty:	Size: 3/4"	Qty:
Blue.....	8	Blue.....	2	Blue.....	1
Black.....	8	Black.....	2	Black.....	1
Orange.....	8	Orange.....	2	Orange.....	1
Green.....	8	Green.....	2	Green.....	1
Yellow.....	8	Yellow.....	2	Yellow.....	1
Size: 3/16"	Qty:	Size: 1/2"	Qty:		
Blue.....	11	Blue.....	2		
Black.....	11	Black.....	2		
Orange.....	11	Orange.....	2		
Green.....	11	Green.....	2		
Yellow.....	11	Yellow.....	2		



KTI70048 Micro Butane Turbo-Lite

- CPSC (Consumer Product Safety Commission) compliant multi-purpose micro-torch/lighter
- Piezo electronic ignition system
- Protective flip-open cap
- Covered by a 1-year warranty
- Flame temperature: 2,400° F (1,300° C)
- Stylish see through fuel tank
- Reliable windproof lighter

KTI70052 Hand Held Butane Torch Lighter

- Handy pocket butane torch
- Light duty soldering such as:
 - shrinking heat seal tubing, craft projects,
 - thawing frozen locks, lighting camp stoves
- 1 Year Warranty on material and workmanship



Shop Tools | Heating, Welding, Soldering

KTI70054

Mini Butane Torch

- Mini butane torch with solder head
- Piezo-electric ignition with locking safety mechanism
- Temperature and flame control, up to 2372° F jet flame
- Removeable safety stand
- 1 Year Warranty on material and workmanship



Mini butane torch with solder head has many uses: solder copper pipes, thaw frozen pipes, repair gutters, remove paint and putty, light fireplaces, cooking torch and all other professional repair jobs.

KTI70058

Hand-Held Pro Butane Torch

- The original hand-held, lightweight and sturdy professional torch
- Piezo ignition and safety kill/off switch
- Adjustable air flow and gas flow control valves
- Tank contains fuel for 190 minutes of operation at mid setting
- Alloy die casting housing covered with a protective grip and sturdy removable base for added safety
- Covered by a 1-year warranty
- Flame temperature: 2,400° F (1,300° C)



KTI70057

Self Igniting

Propane Torch Head

- Self igniting propane torch head with piezo igniter for instant flame
- Safety lock feature to prevent accidental ignition
- Ignition button lock for continuous use
- Replacement brass tip
- Ergonomic handle design
- 1 Year Warranty on material and workmanship



Self Igniting Propane Torch Head for use with MAPP or propane gas.

KTI70056

Self Igniting

Propane Torch Head

- Portable and lightweight
- Easy on/off valve
- High energy flame
- Angled swivel tube to reach difficult areas
- 1 Year Warranty on material and workmanship



Self Igniting Propane Torch Head for use with MAPP or propane gas.

KTI70050

Butane Fuel

- 1.5 fl.oz. (42g) professional-grade butane fuel
- Universal filling tip for use with most refillable butane products
- Adapters are not normally required when refilling tanks
- Double scrubbed and triple filtered for trouble-free use
- Use for pocket torches, lighters, lanterns, table torches and other butane-powered tools



KTI70461

Child Safety Blanket

- Made from Kovenex® flame resistant fabric
- Protects infants from heat and flame
- Patented fabric is made with inherently flame resistant fibers with no chemical treatment for an infinite shelf life
- Soft, durable and light weight
- Machine washable, no bleach
- Weight: 7.0 oz /yd2



KTI70440

Torch Shield

- Size: 10" x 18"
- Carbon fiber flame blocking fabric
- Protect surfaces from sparks or open flame from gas torches with this patented Pavenex® carbon fiber shield
- Withstands even the extreme heat of acetylene torches



KTI70450

Welding Blanket

- Extreme protection
- Size: 50" x 80"
- A high-tech carbon fiber welding blanket made with the Pavenex® fabric (US Patent # 6,696,374)
- Lightweight, soft, and flexible
- Provides protection against direct contact with flame, sparks, and weld spatter
- Withstands temperatures up to 2200°F without shrinking

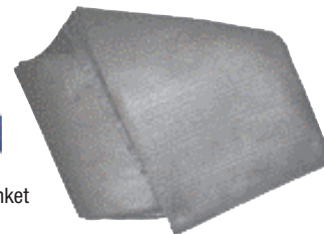

Reduces the chance of sparks damaging fabrics, pitting glass, or marring paint. Will not scratch any painted surface. Can be used in emergencies to smother small fires in a car or anywhere in the shop. Warning: Avoid contact with flammable liquids. Flammable liquids will ignite when exposed to sparks or flame. Always inspect welding blankets for damage before use. Avoid sharp edges or other obstructions to prevent damage to blanket. Clean blanket after each use. To clean, shake the blanket and replace in the original bag. DO NOT clean with water or other liquids. Do not use when wet.

Shop Tools | TPMS



KTi71999 Master TPMS Kit

- The most complete TPMS shop solution available and includes the only sensor activation tool you need

Kit includes the Programming Interface Module (with one year of updates), tool holster, "Guide to TPMS" Training DVD, 2010 PST-TIPS Quick Reference Guide on CD-ROM, TPMS Quick Spec Flip Chart, valve core torque tool and TPMS four-way valve tool. Also includes Service Procedure Poster; an easy to read step-by-step guide for servicing vehicles with Tire Pressure Monitoring Systems (TPMS).



KTi71989 Essential TPMS Combination Kit

- Everything you need in one handy, economical kit
- Universal sensor activation - only tool you need
- Audio and visual confirmation - no guesswork
- Digital protocol upgrades available - never out of date
- Handy and easy to use - no special training required

Contains TPMS tool, instructional DVD, programming interface module (PIM) with one year of updates.



KTi71990A Sensor Activation Tool with Quick Reference Guide on CD-ROM and Quick Spec Flip Chart

- The only patented universal triggering tool you need for testing and resetting the TPM system
- Eliminates the need for multiple tools to service various makes and models of vehicles
- TPMS Quick Reference Guide on CD-ROM is a comprehensive listing of today's TPM systems, reset procedures and sensor learn procedures through the 2010 model year
- The guide includes a quick reference table designed to provide a single point of reference for determining when TPM systems require resetting as well as sensor nut torque requirements

The laminated TPMS Quick Spec Flip Chart is designed for the shop environment, and provides a quick but comprehensive snapshot of today's TPM systems.



KTi71991 Programming Interface Module

- Provides the critical link to update your PST or TIPS tool
- One cable connects to a USB port on your computer and the other to a mini-USB located within the battery compartment of the tool

The PIM is a required accessory, allowing you to download updates to your TPM tool. Each PIM is shipped with a software license valid for one TPM tool for one year from date of purchase. TPM tool must be registered to receive software updates.

Warranty information for KTIpst, PIM and TPMS Scan Tool:
3-year warranty. Repair or replace at the discretion of the repair center. Consumable items are not covered.



SHOP TOOLS

Shop Tools | TPMS



KTI71993 KTIpst Instructional DVD

- Provides an excellent overview of Tire Pressure Monitoring Systems (TPMS,) as well as step-by-step instructions on how to use PST tool.



KTI71992 Heavy-duty Holster for KTIpst

- Provides the perfect blend of utility and protection for your TPM tool
- Unique design allows operation of tool without removing it from the holster
- Can be easily removed
- Clips comfortably to your belt
- Features elastic pockets for easy storage of your accessory tools (tire pressure gauge, tire crayon, tire tread depth gauge, etc.)
- Made of a durable fabric that provides protection from drops and spills

KTI71981 TPMS T-10 Torque Limited Screwdriver



- Facilitates installation of snap-in valves on some Schrader rubber-stemmed sensors
- Installs screws to recommended torque for proper sealing and secure installation
- Assists mechanics to consistently achieve proper torque
- Easy to use • Stored in handy plastic case

LIFETIME WARRANTY*

Replacement parts:

KTI18810 - T-10 Replacement Bit



KTI71996 TPMS Valve Core Torque Tool

- Durable, precision torque tool used to remove and install TR C1 valve cores
- Safely tightens valve cores to meet manufacturer's requirements for proper torque requirements

LIFETIME WARRANTY*

Vehicle manufacturers recommend replacing TPMS electroless, nickel-plated valve cores whenever a tire with TPMS is serviced.



KTI71982 TPMS T-20 Torque Limited Screwdriver

- Used to tighten the torx screw in Beru and other similar TPMS sensors
- The torx screw secures the valve stem to the sensor body
- Preset to 35 in./lbs. (4.0Nm) so the torx screw cannot be over-tightened which may lead to sensor damage and/or incorrect operation
- Also used to remove the torx screws

LIFETIME WARRANTY*

Replacement parts:

KTI18820 - T-20 Replacement Bit



LIFETIME WARRANTY*



KTI71997 TPMS Valve Nut Tool

- Durable, all-in-one tool used for removing the sensor nuts and seating the sensor grommets
- Ergonomically design
- Quickly removes both 11 mm and 12 mm nuts
- Easily seats both beveled and non-beveled grommets

Vehicle manufacturers recommend replacing TPMS sensor nuts and grommets whenever a tire with TPMS is serviced.

Warranty information: Dymanic TPMS products are covered by a 1-Year Warranty.

DynamicTM

TPMS Solutions

- Dual Valve Technology
- Installs right out of the box
- Works with all TPMS scan tools
- Saves time
- Saves money
- Reduces inventory
- Increases shop productivity and profits



DVT – Dual Valve Technology Multi-Vehicle-Application Sensors

DVT-Sensors are designed to work with either a rubber snap-in valve stem or the metal clamp-in valve stem. The technology makes the DVT-Sensor very versatile. It's easy to match the valve style on TPMS equipped vehicles without requiring an additional part number. Just remove the DVT snap-in or clamp-in stem and replace it with the required valve.

DVT-Sensors for domestic applications are supplied with the rubber snap-in valve stem. Asian and European applications are supplied with the metal clamp-in valve stem.



DVT-Sensors provide over 90% coverage for Domestic, Asian and some European cars and light trucks.

Multi-Vehicle Applications

DVT-sensors have the ability to work on more than one vehicle application. Each DVT-Sensor contains multiple vehicle protocols which provide a wider range of coverage. One DVT-Sensor can replace many OEM sensors.

Part #	MHz	Multi-Vehicle Application	DVT Valve
ABDDVT-1000	315 MHz	2004-06 Chevy, GMC, Hummer	DVT-CV-1
ABDDVT-1001H	315 MHz	GM	DVT-SV-1
ABDDVT-1002H	315 MHz	Ford/Chrysler	DVT-SV-1
ABDDVT-1003A	433 MHz	Ford/Chrysler	DVT-SV-1
ABDDVT-1004A	315 MHz	Toyota/Nissan	DVT-CV-1
ABDDVT-1005	315 MHz	Honda/Toyota	DVT-CV-1
ABDDVT-1006	315 MHz	Hyundai/Kia	DVT-CV-1
ABDDVT-1007	315 MHz	Audi/Mercedes/Subaru/VW/Volvo	DVT-SV-1
Part #	MHz	1:1 Vehicle Application (Hi-Line)	Valve
ABDDY-2416	315 MHz	Ford/Chrysler	Metal
ABDDY-2116	433 MHz	Ford/Chrysler	Metal

ALWAYS complete the vehicle relearn procedure when replacing a TPMS sensor or servicing TPMS.

Dynamic Dual Valves Replacements

ABDDVT-SV-1

Snap-in Valve for DVT-Sensors.
Includes S7 nut and cap. Box of 4.



ABDDVT-CV-1

Clamp-in Valve for DVT-Sensors.
Includes nut, grommet, cap and T10 screw. Box of 4.



Warranty information: Dynamic TPMS products are covered by a 1-Year Warranty.



TPMS Solutions



The OEM requires that the valve stem components are replaced every time the tire is serviced on vehicles with TPMS.



Clamp-in Kit Component	Replacement Reason	Result
(A) Grommet/seal	Crack, deteriorate and leak over time	Leak path at valve stem
(B) Hex nut	Plating worn off, threads corrode	Leak path at valve stem
(C) Valve core	Nickel plating strips leading to galvanic corrosion and seized valve cores	Leak at valve core, potential broken valve stem
(D) Valve cap w/seal	Valve cap seal wear	Allows moisture into core
(E) Metal washer (some applications)	Washer conforms to rim during installation	Leak path at valve stem
Snap-in Kit Component	Replacement Reason	Result
(F) Rubber TPMS snap-in valve	Crack, deteriorate and leak over time	Leak path at valve stem

Refer to manufacturer's specifications for proper torque requirements when replacing hex nuts and valve cores. These specifications can be found in the Dynamic TPMS Service Kit Application Guide.

ABD6-102

Buick, Cadillac, Chevy, GMC, Isuzu, Pontiac, Saab

Cross-reference: 20004, 1070K, 92-0125



ABD6-110

Audi, BMW, Land Rover, Mercedes, Mini, Porsche, VW

Cross-reference: 20023, 1090K, 92-0261



ABD6-117

Lexus

Cross-reference: 20033, 1120K, 92-0155



ABD6-103

Cadillac, Chevy, Chrysler, Dodge, Infinity, Isuzu, Jeep, Mitsubishi, Nissan, Subaru

Cross-reference: 20003, 1080K, 92-0140



ABD6-111

Acura, Honda, Lexus, Pontiac, Scion, Toyota

Cross-reference: 20032, 1100K, 92-0215



ABD6-120

Chrysler, Dodge, Infinity, Jeep, Lincoln, Mazda, Mercury, Pontiac, Saturn, Subaru, Suzuki

Cross-reference: 20016, 2030K, 92-202



ABD6-106

Ford, Lincoln, Mercury, Mercedes

Cross-reference: 20002, 1060K, 92-0115



ABD6-112

Honda, Infiniti, Mitsubishi, Nissan

Cross-reference: 20010, 1130K, 92-0130



ABD6-122

Saab, Saturn, Suzuki, Volvo

Cross-reference: 20009, 2010K, 92-0195



ABD6-108

Buick, Cadillac, Chevy, Chrysler, Dodge, GMC, Hyundai, Jaguar, Jeep

Cross-reference: 20030, 1050K, 92-0150



ABD6-115

Audi, VW

Cross-reference: 20017, 1030K, 92-0235



ABD6-125

Cadillac, Chevy, GM, GMC

Cross-reference: 20015, 2020K



ABD6-109

Acura, Honda, Hyundai, Kia

Cross-reference: 20021, 2000K, 92-0246



ABD6-116

GMC, Hummer, Lexus, Toyota, VW

Cross-reference: 20031, 1110K, 92-0135



ABD6-127

Acura, Honda, Hyundai, Kia

Cross-reference: 20019, 2040K, 92-0244



DynamicTM

TPMS Solutions

ABD6-129

VW
Cross-reference:
20017, 1031K



ABD6-138

Honda, Hyundai, Jaguar,
Kia, Land Rover, Mazda,
Mitsubishi, Suzuki,
VW, Volvo
Cross-reference:
20032, 7020K, 92-3312



ABD6-139

Chrysler, Dodge, Jeep,
Nissan
Cross-reference:
20013, 7000K, 92-3311



ABDDVT-493

S7 Nut for DVT Snap-In Valve

Box of 50



ABDDVT-806

T10 Torx Screw for DVT Clamp-In Valve

Box of 50



ABDDY-128G

Valve Cap— Nylon (Grey)

Box of 50



ABDDY-158

Black Valve Cap for Schrader 20008

Box of 50



ABDDY-128B

Valve Cap— Nylon (Black)

Box of 50



ABDDY-1400

TPMS Nickel Plated Valve Core

Box of 50



ABDDY-TPMS-16

Valve Maintenance Kit Assortment

ABDDY-TPMS-16 Valve Maintenance Kit contains 15 of the most popular kits for most domestic and imported cars and light trucks. Also included are 50 each of the TPMS valve caps and nickel plated valve cores.



Kit #	General Application	Qty
ABD6-102	General Motors	10
ABD6-103	Chrysler, Dodge, Mitsubishi	10
ABD6-106	Ford	10
ABD6-108	GM, Chrysler, Dodge, Mazda, Volvo	10
ABD6-109	Acura, Honda, Hyundai, Kia	10
ABD6-110	Audi, BMW, Mercedes	10
ABD6-111	Honda, Lexus, Pontiac, Toyota, Scion	10
ABD6-115	Audi, VW	10
ABD6-116	Lexus, Toyota	10
ABD6-120	Chrysler, Dodge, Jeep	10
ABD6-122	Mitsubishi, Saab, Suzuki, Volvo	10
ABD6-127	Acura, Honda, Kia	10
ABD6-138	Honda, Hyundai, Kia, Mitsubishi	10
ABD6-139	Chrysler, Dodge, Jeep, Nissan	10
ABD6-207A	GM, Ford	10
ABDDY-1400	TPMS Nickel Plated Valve Cores	50
ABDDY-128G	Valve Cap – Nylon (Grey)	50

Warranty information: Dynamic TPMS products are covered by a 1-Year Warranty.

SHOP TOOLS

ABD6-201

Chrysler, Dodge
Jeep, Mitsubishi
Cross-reference:



ABD6-203

Chrome Valve for Ford Shelby Cobra
Optional replacement for 6-207A
Cross-reference:
VS-925C



ABD6-204

Acura, Honda (Long Valve)
Cross-reference:
20035, 1097K



ABD6-205

Acura, Honda (Short Valve)
Cross-reference:
20036, 1096K



ABD6-206B

Mercedes, Smart
Cross-reference:
20023, 1040K, 92-1170



ABD6-207A

Chrysler, Dodge, Ford, GM,
Hummer, Jeep, Mazda, Mercury,
Subaru, Suzuki
Cross-reference:
20018, VS950, 92-0145



ABD6-208

Cadillac ATS, Dodge Dart
Cross-reference:
VS-90



ABD6-209

Hyundai
Cross-reference:
V1010



ABD6-210

Hyundai, Kia
Cross-reference:



ABD6-211

Dodge TRW Snap-In,
Jeep, Ram
Cross-reference:
VS65



ABD6-213

Ford 2015
Cross-reference:



ABD6-218

Dodge Sprinter
Cross-reference:
20036, 1098K, 92-1170



ABD6-220

Audi 4, BMW, Porsche
Gen I (Silver - 43 mm)
Cross-reference:
1092, RDV001



ABD6-221

BMW
Gen I (Green - 48 mm)
Cross-reference:
1093, RDV002

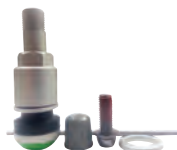

ABD6-222

BMW, Mercedes
Gen I (Black - 49 mm)
Cross-reference:
1094, RDV003



ABD6-223

BMW, Mercedes
Gen I (Orange - 51 mm)
Cross-reference:
1095, RDV004



ABD6-225

Aluminum Optional Replacement
Valve for 6-207A
Cross-reference:
VS925A, 34000



ABD6-228S

Chrysler, Dodge, Jeep,
Mercedes
Cross-reference:
9066K



ABD6-231C

Adjustable Valve for Chrysler,
Dodge, Honda, Jeep
Cross-reference:
VS-70



ABD6-236

Hyundai, Kia
Cross-reference:
VS965



ABD6-240

Audi, BMW, Mercedes, VW
Gen II (Silver - 43mm)
Cross-reference:
RDV021



ABD6-241

BMW
Gen II (Green - 48mm)
Cross-reference:
RDV022



ABD6-242

Audi, BMW, Porsche, VW
Gen II (Black - 49mm)
Cross-reference:
RDV023



ABD6-243

BMW
Gen II (Orange - 51mm)
Cross-reference:
RDV024



DynamicTM

TPMS Solutions

Kit #	General Application	Qty
ABD6-203	Chrome Valve for Ford Shelby Cobra	4
ABD6-204	Acura, Honda (Long Valve)	4
ABD6-205	Acura, Honda (Short Valve)	4
ABD6-206B	Mercedes, Smart	4
ABD6-207A	Ford, GM	10
ABD6-208	Cadillac ATS, Dodge Dart	4
ABD6-209	Hyundai Santa Fe	4
ABD6-211	Dodge Ram, Jeep	4
ABD6-218	Dodge Sprinter	2
ABD6-220	Audi, BMW, Porsche (Silver - 43 mm)	2
ABD6-222	BMW, Mercedes (Black - 49 mm)	2
ABD6-225	Aluminum Optional Valve Replacment for 6-207A	4
ABD6-228S	Chrysler, Dodge, Jeep	4
ABD6-231C	Adjustable Valve for Chrysler, Dodge, Honda, Jeep	4
ABD6-240	Audi, BMW, Porsche, VW (Silver - 43 mm)	2
ABD6-242	Audi, BMW, Porsche, VW (Black - 49 mm)	2

ABDDY-TPMS-16VS Valve Stem Assortment

For the replacement of corroded or broken TPMS valve stems. The ABDDY-TPMS-16VS assortment contains 16 of the most popular valve stems.



European TPMS Aftermarket Replacement Valve Stems

The OEM has two different designs of replaceable valve stems with their TPMS sensors – Generation I and Generation II. Gen I and Gen II valve stems utilize a different thread pitch and therefore the service repair kits use different components and cannot be interchanged. The difference in the valve stems and the service kits is detailed below.

Generation I



Dynamic Valve Kit w/ Valve Stem	Dynamic Service Kit w/o Valve Stem	OEM No.	Valve Length	Color Coded Noted at Base of Valve Stem
ABD6-220	ABD6-110	RDV001	43 mm	Silver
ABD6-221	ABD6-110	RDV002	48 mm	Green
ABD6-222	ABD6-110	RDV003	49 mm	Black
ABD6-223	ABD6-110	RDV004	51 mm	Orange



T-20 screw
(35in-lb torque)



10V2 thread hex nut
w/o shear collar

Only use ABD6-110 service kit with Gen I valve stems

Generation II



Dynamic Valve Kit w/ Valve Stem	Dynamic Service Kit w/o Valve Stem	OEM No.	Valve Length	Color Coded Noted at Base of Valve Stem
ABD6-240	ABD6-109	RDV021	43 mm	Silver
ABD6-241	ABD6-109	RDV022	48 mm	Green
ABD6-242	ABD6-109	RDV023	49 mm	Black
ABD6-243	ABD6-109	RDV024	51 mm	Orange



M5 square head
screw (torque set by hex nut)



7/16"-18 thread
hex nut with shear collar

Only use ABD6-109 service kit with Gen II valve stems

Warranty information: Dynamic TPMS products are covered by a 1-Year Warranty.

Start servicing TPMS vehicles now with these Dynamic TPMS starter kits.

Designed for lighter volume shops the ABDDVT-12SK contains all of the OEM aftermarket parts needed to start servicing TPMS equipped vehicles without making a large investment.

ABDDVT-12SK TPMS Valve Maintenance/Sensor Starter Kit



Part #	Qty
DVT-Sensors	
ABDDVT-1001H	2
ABDDVT-1002H	2
ABDDVT-1003A	2
ABDDVT-1004A	2
ABDDVT-1005	2
ABDDVT-1006	2
DVT Replacement Valves	
ABDDVT-SV-1	4
ABDDVT-CV-1	4
Torque Tool	
ABDDY-002A	1
Counter Card	
ABDDYN-0513*	1
Application Guide & Catalog	
ABDDVT-APP*	1
ABDDY-TPMS-13*	1

Part #	Qty
ABDDY-TPMS-16 TPMS Valve Maintenance Kit	
ABD6-102	10
ABD6-103	10
ABD6-106	10
ABD6-108	10
ABD6-109	10
ABD6-110	10
ABD6-111	10
ABD6-115	10
ABD6-116	10
ABD6-120	10
ABD6-122	10
ABD6-127	10
ABD6-138	10
ABD6-139	10
ABD6-207A	10
ABDDY-1400	50
ABDDY-128G	50

ABDDVT-SK12VS TPMS Valve Stem/Sensor Starter Kit



Part #	Qty
DVT-Sensors	
ABDDVT-1001H	2
ABDDVT-1002H	2
ABDDVT-1003A	2
ABDDVT-1004A	2
ABDDVT-1005	2
ABDDVT-1006	2
DVT Replacement Valves	
ABDDVT-SV-1	4
ABDDVT-CV-1	4
Torque Tool	
ABDDY-002A	1
Counter Card	
ABDDYN-0513*	1
Application Catalog	
ABDDVT-APP*	1
TPMS Catalog	
ABDDY-TPMS-13*	1

Part #	Qty
ABDDY-TPMS-16VS Valve Stem Replacement Kit	
ABDDY6-203	4
ABDDY6-204	2
ABDDY6-205	4
ABDDY6-206B	4
ABDDY6-207A	4
ABDDY6-208	4
ABDDY6-209	4
ABDDY6-211	4
ABDDY6-218	2
ABDDY6-220	2
ABDDY6-222	2
ABDDY6-225	4
ABDDY6-228S	4
ABDDY6-231C	4
ABDDY6-240	2
ABDDY6-242	2

* Indicates Parts Only Available In The Kit and Not Sold Separately

Warranty information: Dynamic TPMS products are covered by a 1-Year Warranty.

ABDDVT-802 TPMS Master Starter Kit



This master starter kit contains all of the parts needed to service TPMS vehicles including, DVT-Sensors, Valve Maintenance Kits and TPMS Replacement Valves.

The ABDDVT-802 includes: 32 DVT-sensors, 256 TPMS valve maintenance kits & replacement valve stems, torque tool and our ABDTPMS-72 storage cabinet.

Dynamic
TPMS Solutions

NOTE: Will be shipped in two boxes.

Part #	Description	Qty
DVT-Sensors		
ABDDVT-1000	TPMS Sensor - 2004-06 Chevy - GMC	2
ABDDVT-1001H	TPMS Sensor - GM 314.9/315 MHz	6
ABDDVT-1002H	TPMS Sensor - Ford/Chrysler 315 MHz	6
ABDDVT-1003A	TPMS Sensor - Ford/Chrysler 433 MHz	4
ABDDVT-1004A	TPMS Sensor - Toyota/Nissan 315 MHz	4
ABDDVT-1005	TPMS Sensor - Honda 315 MHz	4
ABDDVT-1006	TPMS Sensor - Hyundai/Kia 315 MHz	4
ABDDVT-1007	TPMS Sensor - Subaru/Suzuki/Volvo 315 MHz	2
DVT Replacement Valve Stems		
ABDDVT-SV-1	DVT Snap-In Valve Stem	4
ABDDVT-CV-1	DVT Clamp-In Valve Stem	4
DVT Valve Stem Torque Tool		
ABDDY-002A	TPMS Torque Tool	1
Replacement Valve Stems		
ABD6-203	TPMS Replacement Valve Stem	4
ABD6-204	TPMS Replacement Valve Stem	4
ABD6-205	TPMS Replacement Valve Stem	4
ABD6-206B	TPMS Replacement Valve Stem	4
ABD6-207A	TPMS Replacement Valve Stem	20
ABD6-208	TPMS Replacement Valve Stem	4
ABD6-209	TPMS Replacement Valve Stem	4
ABD6-211	TPMS Replacement Valve Stem	4
ABD6-228S	TPMS Replacement Valve Stem	4
ABD6-231C	TPMS Replacement Valve Stem	4

Part #	Description	Qty
TPMS Valve Maintenance Kits		
ABD6-102	TPMS Service Kit	10
ABD6-103	TPMS Service Kit	10
ABD6-106	TPMS Service Kit	10
ABD6-108	TPMS Service Kit	10
ABD6-109	TPMS Service Kit	10
ABD6-110	TPMS Service Kit	10
ABD6-111	TPMS Service Kit	10
ABD6-112	TPMS Service Kit	10
ABD6-115	TPMS Service Kit	10
ABD6-116	TPMS Service Kit	10
ABD6-117	TPMS Service Kit	10
ABD6-120	TPMS Service Kit	10
ABD6-122	TPMS Service Kit	10
ABD6-125	TPMS Service Kit	10
ABD6-127	TPMS Service Kit	10
ABD6-129	TPMS Service Kit	10
ABD6-138	TPMS Service Kit	10
ABD6-139	TPMS Service Kit	10
DVT Cabinet & Application Catalog		
ABDTPMS-72*	Storage Cabinet	1
ABDDVT-APP*	Application Catalog	1

* Indicates Parts Only Available In The Kit and Not Sold Separately

Warranty information: Dynamic TPMS products are covered by a 1-Year Warranty.





TPMS Solutions

Service procedures for replacing TPMS sensors and installing TPMS service kits require the proper tools.

ABDDY-001A

Torque Wrench With Sockets



ABDDY-S11 & ABDDY-S12 Sockets sold separately.

Torque wrench is used for installing TPMS sensor nuts. Torque range is from 30 in-lbs (3.4 N-m) to 120 in-lbs (13.6 N-m). Includes 11 mm and 12 mm sockets. Comes in a plastic storage case.

ABDDY-002A

Torque Tool for Valve and Sensor



Torque tool is used for installing valves on DVT-sensors. Comes with T10 Torx bit for the clamp-in valve and a S7 socket for the snap-in valve. 12 in-lbs (1.4 N-m)

ABDDY-150

Valve Core Torque Tool

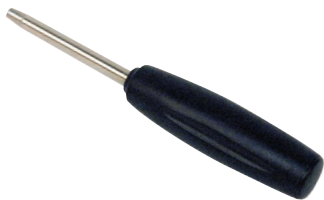

Tightens valve cores to OE specifications, 3.5-4 in-lbs (.45 N-m). Meets industry recommended torque values. Can also be used to remove valve cores.

ABDDY-164

Grommet Removal Tool

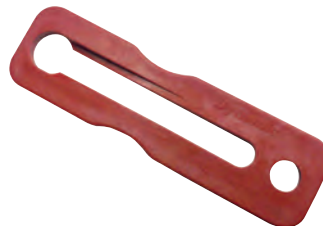

This tool is used to remove the old grommet from the TPMS aluminum valve stem.

ABDDY-172

Grommet Pick Tool



This tool is used to help remove old and broken grommets from the TPMS aluminum valve stem.

ABDDY-32VNT

TPMS 4-Way Valve Tool



Use this tool for removing sensor nuts and seating the sensor grommets. It can be used to remove 11 mm and 12 mm nuts.

ABDDY-312

Complete TPMS Service Tool Kit

The ABDDY-312 contains all of the tools needed to service and install TPMS sensors and service kits. All tools are stored and organized in a sturdy plastic case.

Kit includes:

ABDDY-001A	Torque Wrench with 11 mm & 12 mm sockets
ABDDY-002A	Torque Tool for Valve & Sensor
ABDDY-150	Valve Core Torque Tool 12 in-lbs (.45 N-m)
ABDDY-164	Grommet Removal Tool
ABDDY-172	Grommet Pick Tool



ABDDY-7

S7 Replacement Socket for ABDDY-0002A Tool

Pack of 2



Warranty information: Dymanic TPMS products are covered by a 1-Year Warranty.

Shop Tools | Water Hoses



theBlueHose Water Hoses

- 500 PSI 100% rubber water hose with 3/4" GHT couplings
- Ultra lightweight, durable and super strong premium grade hot water hose
- Constructed with high strength polyester braided reinforcement with ozone resistant cover providing protection from extreme weather, abrasions and kinks
- Flexibility in extreme conditions from -50 to 180° Fahrenheit
- Oil resistance core tube meets RMA Class C oil resistance and four finger grip bend restrictor for easy use and better durability
- 10 Year Warranty

Solid crush-proof chrome plated brass fittings and handles hot water up to 200° Fahrenheit.

Part #	Description
KTI72079	5/8" x 25' theBlueHose Water Hose
KTI72080	5/8" x 50' theBlueHose Water Hose
KTI72081	5/8" x 100' theBlueHose Water Hose
KTI72082	3/4" x 50' theBlueHose Water Hose
KTI72083	3/4" x 100' theBlueHose Water Hose
KTI72084	1" x 50' theBlueHose Water Hose
KTI72085	1" x 100' theBlueHose Water Hose

Shop Tools | Cleaning



KTD77601

GlassMaster Pro Kit

- The patented GlassMaster Pro effortlessly cleans hard-to-reach areas, including windshields, glass doors, dashboards and much more
- Great for cars, SUVs, trucks, minivans, boats, home and office
- Spray favorite cleaners directly on GlassMaster Pro, eliminating overspray on dashboards, sensitive electronics, furniture, etc
- Wand boasts super-strong I-beam construction and premium grade ABS materials
- Thick comfort grip handle
- Use one detachable head for wet cleaning / scrubbing. Use second head for drying/polishing

Kit includes the long-handled GlassMaster Pro wand, two interchangeable cleaning heads, three fitted bonnets, plus a bonus stow-and-go storage bag.

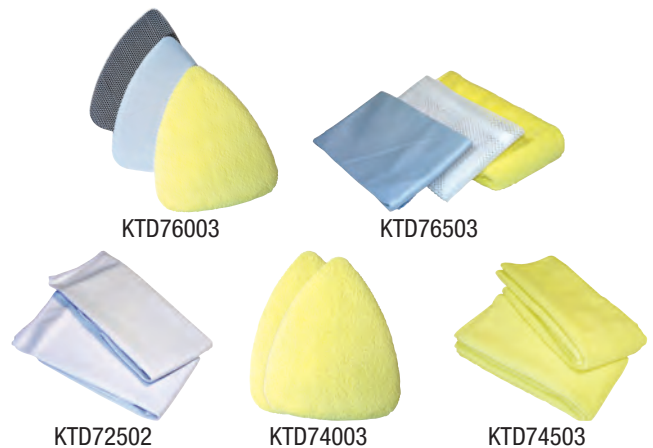

GlassMaster Pro Replacement Parts and Accessories:

- KTD72004 - GlassMaster Pro Microfiber Bonnets 3-pack
- KTD72502 - GlassMaster Pro Microfiber Cloth 2-pack
- KTD74003 - GlassMaster Pro Terry Cloth Bonnets 2-pack
- KTD74004 - GlassMaster Pro Terry Cloth Bonnets 3-pack
- KTD74503 - GlassMaster Pro Multipurpose Cloths 2-pack
- KTD76003 - GlassMaster Pro Assorted Bonnets 3-pack
- KTD76503 - GlassMaster Pro Assorted Cloths 3-pack

SHOP TOOLS

Shop Tools | **Cleaning**

KTD77604

Glassmaster Pro-Poly Bagged

- Professional glass and surface cleaner that cleans faster, easier, and with superior results
- Great for cars, trucks, SUV's, mini vans, RV's, boats, home and the work place
- Kit includes: 14" comfort grip handle, 2 multi-purpose cleaning heads, microfiber glass cleaning bonnet, multi-purpose microfiber cleaning bonnet and nylon mesh cleaning bonnet

KTD77610 - Glassmaster Extension Handle

KTD77621 - Mini-Pro Paddle IGRC - Yellow

KTD77622 - Mini-Pro Paddle GMP - Black



Shop Tools | **Clamps & Vises**



C-clamps

Adjustable C-clamps manufactured from ductile iron.

Sold separately:

KTI70182 - 2"

KTI70183 - 3"

KTI70184 - 4"

KTI70186 - 6"

KTI70188 - 8"

LIFETIME WARRANTY*

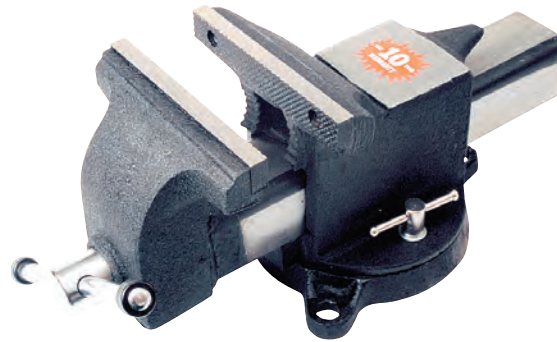

Steel Bench Vises

Rugged all-steel vise is stronger than its cast iron counterpart. Vise features swivel base and large anvil space for hammering.

Warranty information:

10-year limited warranty.

Jaws are not covered.

Part #	Vise Size	Center to Center Measurement	Usable Jaw Opening	Weight
KTI64105	5"	3-1/2"	5-1/4"	27 lbs.
KTI64106	6"	4-1/2"	6-1/2"	35 lbs.
KTI64108	8"	5-1/4"	8-1/2"	50 lbs.

Replacement parts:

KTI64001 - Replacement screws

KTI64005 - 5" jaws

KTI64006 - 6" jaws

KTI64008 - 8" jaws



Shop Tools | Adhesives & Tapes

Q-Bond®



KT190005

Q-Bond Large Repair Kit (QB3)

- Ultra-strong adhesive and reinforcing powders
- Repairs almost everything
- Rock solid in 10 seconds
- Q-Bond repairs are able to be grinded, filed, sanded and even painted

Kit includes six (6) bottles Q-Bond adhesive (0.35oz/10ml); two (2) bottles black reinforcing powder for plastics; one (1) bottle grey reinforcing powder for metals.

KT190002

Q-BOND Adhesive Kit

- Ultra-strong adhesive and reinforcing powders
- Repairs almost anything
- Rock solid in 10 seconds
- Q-Bond repairs are able to be grinded, filed, sanded and even painted
- Includes 2 Q-BOND adhesive; 1 black reinforcing powder; 1 grey reinforcing powder



Q-BOND can be used just as an adhesive or with the reinforcing powders that will help to repair almost anything. The Q-BOND kit includes two (2) bottles Q-BOND adhesive (0.35oz/10ml); one (1) bottle black reinforcing powder for plastics; one (1) bottle grey reinforcing powder for metals.

KT190002C

Q-Bond Adhesive Kit for Canada

- Ultra-strong adhesive and reinforcing powders
- Repairs almost anything
- Rock solid in 10 seconds
- Q-Bond repairs are able to be grinded, filed, sanded and even painted

The Q-BOND kit includes two (2) bottles Q-BOND adhesive (0.35oz/10ml); one (1) bottle black reinforcing powder for plastics; one (1) bottle grey reinforcing powder for metals.



KT190003

Q-Bond Adhesive Kit, 10 Pack with Display

- Ultra-strong adhesive and reinforcing powders
- Repairs almost anything
- Rock solid in 10 seconds
- Q-Bond repairs are able to be grinded, filed, sanded and even painted
- Hang tabs for pegboard and rack displays
- New package design with 10 kits per display. Each kit contains 2 Q-Bond adhesives, 1 black reinforcing powder and 1 grey reinforcing powder



New package design with 10 kits in this display. Q-BOND can be used just as an adhesive or with the reinforcing powders that will help to repair almost anything. Q-BOND repairs can be grinded, filed, sanded, and even painted. Each Q-BOND kit includes two (2) bottles Q-BOND adhesive (0.35oz/10ml); one (1) bottle black reinforcing powder for plastics; one (1) bottle grey reinforcing powder for metals.

KT190003C

Q-Bond Adhesive Kit - 10 Pack Display for Canada

KT173550

Pipe Sealing Tape 1/2" x 260"

- 1/2" x 260" for sealing threaded pipe
- Sold in a sleeve of 5 rolls



KT173560

2" x 60 Yards Duct Tape

- Multipurpose gray duct tape for numerous uses
- Roll measures 2" wide x 60 yards

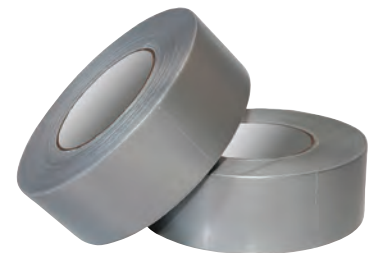

KT173510

Black Electrical Tape

- 3/4" x 60" sleeve of 10 rolls



SHOP TOOLS

Shop Tools | Fluids & Grease



KT173900

Air-powered, Pistol-Grip Grease Gun

- Air pressure ranges from 1,200 psi to 6,000 psi
- Uses 400cc bulk loading or standard 14 oz. cartridge
- Includes rigid and flexible extensions
- Rugged, heavy-duty steel construction
- Portable and nearly effortless to use
- 90 Day Warranty on material and workmanship



KT173962

Continuous Flow Grease Gun, Air Operated

- Air operated continuous flow grease gun, 14 oz / minute
- 3-way loading: 14 oz cartridge, bulk and suction fill
- Develops up to 4,800 PSI
- Air inlet: 40 - 120 PSI
- Supplied complete with 6" steel extension & coupler
- 1-Year Warranty

KT173933

Heavy Duty Pistol Grip Grease Gun 14 oz

- Heavy duty pistol grip grease gun 14 oz
- Die cast aluminum head fitted with steel block nut
- Complete with 18" flexible hose extension & coupler
- 5,000 PSI
- 3-way loading: 14 oz cartridge, bulk and suction fill
- 1-Year Warranty



KT173930

Mini Pistol Grease Gun 3 oz

- 3 oz mini pistol grease gun
- Dual discharge ports with pull type pistol mechanism
- 3,500 PSI
- Complete with 4" steel extension & coupler
- 1-Year Warranty



KT173942

Heavy Duty Lever Grease Gun 14 oz

- Heavy duty aluminum die cast grease gun head fitted with bulk loaded & air release
- 3-way loading: 14 oz cartridge, bulk and suction fill
- Grease gun handle fitted with rubber grip
- Develops up to 10,000 PSI with built-in variable stroke
- Supplied complete with 6" steel extension & coupler
- 1-Year Warranty



KT173905

Standard Lever Grease Gun 14oz

- Standard lever grease gun 14 oz
- 6,000 PSI
- 3-Way loading 14 oz cartridge, bulk and suction fill
- Complete with 6" steel extension & coupler
- 1-Year Warranty

KT173910

Lube Combo Display Shelf Pack

- Pack includes: 3 each: Heavy Duty Pistol Grip Grease Guns (KT173933) 3 each: Heavy Duty Lever Grease Guns (KT173942)
- Aluminium die cast grease gun head
- Lever grease gun develops up to 10,000 PSI; pistol grease gun up to 5000 PSI
- For use with 14 oz. grease cartridges
- Lever gun (KT173942) includes 6" bent steel extension & coupler; pistol gun (KT173933) includes 18" flexible grease hose & coupler
- Covered by a 1-year warranty



KT173919

Suction Gun with 12" Vinyl Hose

- Transfer gun designed to get gear oils both into and out of gear boxes, transfer cases and differentials
- Capacity 16 oz.
- 1-Year Warranty



KT173959

Right Angle Grease Gun Coupler

- 1,000 PSI
- For use with hand grease guns only
- 1-Year Warranty



KTI73952
Professional 4 Jaw
Grease Gun Coupler

- 6,000 PSI
- For hand operated grease guns only
- 1-Year Warranty



KTI73952-54
Grease Gun Coupler
54 Pack Counter Display

- 6,000 PSI
- For use with hand grease guns only
- 1-Year Warranty



KTI73957
Grease Injector Needle

- For universal joints and sealed bearings
- Length: 1-1/2" • Diameter: 18G
- 1-Year Warranty



KTI73903
Needle Nose Dispenser
1-1/2" Narrow

- For use with hand grease guns only
- 1-1/2" x 0.156" needle
- 1-Year Warranty



Grease Gun Hose

- Working pressure: 3,500 PSI
- Burst pressure: 11,600 PSI
- For hand operated grease guns only
- 1-Year Warranty



KTI73912 - 12" KTI73918 - 18"

KTI72205
Barrel Pump - Lever Style

- Two-piece, self-adjusting telescoping suction tube fits 15, 30 or 55 gallon drums
- Removable threaded spout
- Pumps water based fluids, solvents, antifreeze, weak acids and all oil based fluids
- Pumps approximately 300cc liquid per stroke
- Zinc plated for lasting quality
- Features cushioned vinyl handle
- 90 Day Warranty



KTI72210
Lever Transfer Pump
15-55 Gallon Drums

- For use with DEF, antifreeze, detergents, windshield fluids, heavy oils, etc
- Delivers up to 1 pint per stroke
- 1-Year Warranty



KTI72215
Electric Rechargeable
Drum Pump 19.2V

- Cordless pump with 19.2V rechargeable battery
- Compact & lightweight polyacetal body
- Telescopic pump tube for use with 55 gal. (205 Litre) drums as well as 275-330 gal. (1000 to 1250 Litre) IBC's
- Built-in 2" bung & an additional bung converter (2.5" x 5 buttress) for use with plastic drums & IBC's
- Delivers up to 28 lpm (7.4 gpm) or up to 410 litre (110 gal.) on a single battery charge
- Covered by a 1-year warranty



Designed for pumping DEF, diesel, antifreeze, water, detergents, herbicides, pesticides, kerosene, light oils etc. Includes 19.2V Ni Cd rechargeable battery & UL lister quick battery charger.

KTI72250
Deluxe Siphon
Transfer Pump

- Multi use, transfers most liquids
- Pumps air for inflatables
- Use for changing oil, siphoning gas, inflating sports balls and beach toys
- Includes two 51" siphon hoses, 35" dipstick hose and adapter (for changing oil) and 17" air pressure hose



LIFETIME WARRANTY*

KTI72200
Hand Rotary Style Barrel Pump

- Easy to operate crank handle rotary pumps are used as a siphon
- Simply prime pump by turning crank handle several times: liquid automatically siphons to lower level
- Rotary hand pumps fit 15, 30 and 55 gallon drums
- Cast iron rotary pump is ideal for heavy oil, machine oil and non-corrosive liquids
- Barrel pump dispenses one gallon per 14 revolutions
- Made with a cast iron body with steel inlet and outlet tubing
- 2" bung adapter is perfect for drum openings
- 90 Day Warranty



KTI73993
Lever Action Bucket Pump
5 Gallon Pail

- Comes complete with 12" drum cover and 4' PVC hose with steel spout
- Designed for transferring transmission differentials & heavier oils
- Delivers 2.14 oz. (60 ml) per stroke
- 90 Day Warranty on material and workmanship



KTI74605

1-Qt Funnel with Splash Ring and Removeable Flexible Spout

- Removeable flexible spout
- Removeable screen
- Chemically resistant polyethylene

Polyethylene funnel, 1 quart with splash ring, screen and flexible 10-inch removable spout.



Funnel Safety Red with Screen

- Safety Red
- Chemically resistant polyethylene
- With screen

KTI74606 - 2 Quart

KTI74610 - 6 Quart



KTI74612

3 Quart Drum Funnel with Hinged Lid and 2" Bung

- Tough industrial quality
- Chemically resistant polyethylene
- Fits 2" thread
- Hinged lid and 2" bung



KTI74641

Drip Tray 22" x 22" x 1.5"

- Chemically resistant polyethylene
- Collects drips, leaks, and spills
- Dimensions: 22" x 22" x 1-1/2"

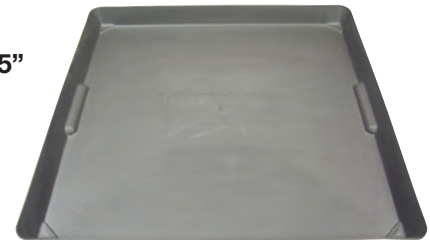

KTI74640

Axle Drain Pan

- Durable and lightweight HDPE plastic with built-in drop proof spouts that help to recycle oil
- Works for most dual and super single wheels, sizes 22.5 and 24.5
- Use with steel and aluminum wheels, hub piloted or stud piloted, drive or trailer axles
- Catches oil, axle nuts, bearings - most anything removed from the wheel end for service
- Attaches with a hand-tightened lug nut

Drain pan works for most dual and super single wheels sizes 22.5 and 24.5. Attaches with a hand-tightened lug nut. Will not tip or spill - virtually eliminating clean up. Works for steel or aluminum wheels, hub piloted or stud piloted, drive or trailer axles. Catches oil, axle nuts, bearings - most anything removed from the wheel end for service. Built in drop proof spouts help to recycle waste oil. Durable and lightweight HDPE plastic.



Double Cap Funnels

- Double capped funnel keeps the drips in and the dirt out
- This ultimate storage funnel eliminates spills and contaminants, reduces debris and is chemically resistant

KTI74607

1 Pint Double Cap Funnel - Orange

- Top ID: 3" • Spout OD: 1/2"
- Height (without cap): 8.75"



KTI74607



KTI74608



KTI74609



KTI74611



KTI74613

KTI74608

1.25 Quart Double Cap Funnel - Dark Blue

- Top ID: 4" • Spout OD: 3/4"
- Height (without cap): 10.5"

KTI74609

1.3 Quart Double Cap Funnel - Black

- Top ID: 4" • Spout OD: 1.375"
- Height (without cap): 16.5"

KTI74611

1.5 Quart Double Cap Funnel - Yellow

- Top ID: 4" • Spout OD: 3/4"
- Height (without cap): 14.25"

KTI74613

1.66 Quart Double Cap Funnel - Dark Red

- Top ID: 4" • Spout OD: 1.375"
- Height (without cap): 14.25"



KTI74647

Antifreeze Drain Pan 4.5 Gallon

- Built-in anti-splash lip & baffles
- Large spout for fast pouring. Includes spout cap for spill protection
- High density polyethylene construction, chemical & solvent resistant
- Green color provides visual identification for use with antifreeze
- Covered by a 1-year warranty



KTI74645

4.25 Gallon Capacity Oil Drain Pan

- Chemical / solvent resistant high density polyethylene construction
- Large spout for fast pouring complete with spout cap
- Built-in ant-splash lip and baffles
- Includes large handle • 1 year warranty

KTI73901

Pistol Style Oiler with Base 6 oz.

- Pistol style oil can with base
- Capacity: 6oz (180 ml)
- Flex spout
- 1-Year Warranty



KTI73902

Lever Oil Can with Flex Spout 1 Pint

- 1 pint (500ml) lever oil can
- Flex spout
- 1-Year Warranty



KTI74601-1

19-1/2" Long Rigid Funnel

- Super deluxe transmission funnel
- Large capacity prevents overflow
- 4-1/2" ID x 19-1/2" long



KTI74601-12

19-1/2" Long Rigid Funnel 12/Pk



KTI74602-1

Long Flexible Transmission Funnel

- Plastic
- With Flexible Hose

KTI74602-12

Long Flexible Transmission Funnel 12/Pk

KTI74603

Funnel Pivoting "The Guzzler"

Large capacity funnel directs flow without spilling. Features ball pivot at base.



KTI74604

Funnel for 55-gallon Drum

Large capacity funnel screws directly onto 55 gallon drums.



KTI74630

3-Piece Funnel Set

KTI's "funnel for every job" set includes 3-1/2", 5-1/2" and 7-1/2" sizes.



KTI74651

5-Liter Translucent Measuring Pitcher with Flexible Spout

- 5-Liter Measure Pitcher
- Flexible Spout
- Translucent

KTI74650

2-Liter Measure Pitcher with Flex Spout

KTI74652

Plastic Measure with Flex Spout - 8 Qt

- Translucent body
- Includes dust cover, flexible spout & cap
- Graduated in quarts & liters
- Covered by a 1-year warranty





KT100023

60-Piece Grease Fitting Kit (SAE)

- Grease fitting assortment kit (SAE) includes 1/4-28 sizes
- The 1/4-28 thread fitting is used on cars, light trucks and industrial machinery
- Requires a tapped hole for installation
- Max pressure is 8,000 psi
- Kit contains 60 pieces of the top 4 sizes: straight, 45° elbow, 90° elbow and long straight fittings

Part #	Description	Qty	Refill
KT104308	1/4" - 28 Straight	20	10
KT104309	1/4" - 28 45°	15	10
KT104310	1/4" - 28 90°	15	10
KT104311	1/4" - 28 Straight (Long)	10	10



KT100024

90-Piece Grease Fitting Kit (Metric)

- Grease fitting assortment kit (metric) includes 6 mm, 8 mm and 10 mm fittings in nine popular sizes
- Kit contains straight, 45° elbow, and 90° elbow fittings packaged in multicompart, refillable plastic case
- Contains product assortment map for easy identification of components

Part #	Description	Qty	Refill
KT104312	6mm x 1.0/Straight	10	10
KT104313	6mm x 1.0/45°	10	10
KT104314	6mm x 1.0/90°	10	10
KT104315	8mm x 1.0/Straight	10	10
KT104316	8mm x 1.0/45°	10	10
KT104317	8mm x 1.0/90°	10	10
KT104318	10mm x 1.0/Straight	10	10
KT104319	10mm x 1.0/45°	10	10
KT104320	10mm x 1.0/90°	10	10



KT100096

110-Piece Metric Grease Fitting Assortment

- 110-piece metric grease fitting assortment kit includes six popular sizes, ranging from 6mm to 10mm

Description	Qty	Description	Qty
6mm	30	10mm (90°)	20
6mm (45°)	15	10mm (45°)	15
6mm (90°)	15	10mm	15



KT100074
110-Piece Hydraulic
Grease Fitting Assortment Fractional

- 110-piece hydraulic grease fitting assortment kit includes six popular sizes from 1/4"-28 to 1/8"-27
- Kit contains straight and 45° and 90° angled fittings

Description	Qty	Description	Qty
1/4"-28	30	1/8"-27 (90°)	15
1/4"-28 (45°)	15	1/8"-27 (45°)	15
1/4"-28 (90°)	15	1/8"-27	20



Grease Fittings		
Part #	Description	Qty
KT104319	Grease Fittings Metric 10MM 45° Elbow	10
KT104320	Grease Fittings Metric 10MM 90° Elbow	10
KT104318	Grease Fittings Metric 10MM Straight	10
KT104313	Grease Fittings Metric 6MM 45° Elbow	10
KT104314	Grease Fittings Metric 6MM 90° Elbow	10
KT104312	Grease Fittings Metric 6MM Straight	10
KT104316	Grease Fittings Metric 8MM 45° Elbow	10
KT104317	Grease Fittings Metric 8MM 90° Elbow	10
KT104315	Grease Fittings Metric 8MM Straight	10
KT104309	Grease Fittings SAE 1/4-28 45° Elbow	10
KT104310	Grease Fittings SAE 1/4-28 90° Elbow	10
KT104311	Grease Fittings SAE 1/4-28 Long Straight	10
KT104308	Grease Fittings SAE 1/4-28 Straight	10



BATTERY TESTERS AND BOOSTER CABLES



1.800.762.6002 | www.ktoolinternational.com



LIFETIME WARRANTY*

**KTI70211
Antifreeze Tester**

- Hydrometer immediately and accurately tests strength of all permanent solutions (ethylene glycol), with engine hot or cold, and includes temperature adjustment scale for accurate interpretation of mixture strength
- Assists in preventing winter freezeup and summer boilover
- Two embedded scales show freeze point of radiator solution and boiling point of summer coolant
- 32°F thru -45°F

**KTI70212
Battery Tester**

- Hydrometer immediately and accurately tests battery life whether battery is hot or cold
- Helps extend battery life and detects overcharge
- Assists in preventing dead batteries
- Works on all 6-, 12- and 24-volt systems

LIFETIME WARRANTY*

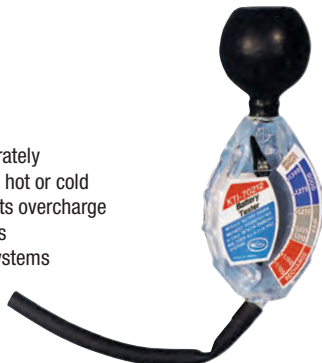

**KTI70210
Carbon Pile Load Tester 500 AMP**

- KTI's 500 AMP carbon pile load tester is great for simulating actual cranking loads
- It tests 12 volt batteries rated as high as 1000 CCA or 160 AMP hour
- Quick 15 second test cycle with audible tone to indicate test completion
- Unit can also test alternators, regulators and starters
- Carbon pile load tester features 500 AMP side clamps and heavy-duty stranded copper cables
- The large, color-coded dual meters make the unit easy-to-use
- Also includes temperature compensation chart
- 1-year warranty; Repair or replace at discretion of repair center



**KTI70215
Battery Tester 100 AMP**

- Extremely handy and portable way to load test suspected low charging batteries
- Internal 100 AMP loading capacity
- Test 6- and 12-volt batteries
- Tool checks battery voltage, starter current draw, charging voltage and battery condition
- Features extra-heavy nickel-plated ventilated case, heavy-duty cable, copper-plated clamps, and load safety switch to prevent arcing
- 1-year warranty; Repair or replace at discretion of repair center



**KTI70216
Digital Battery Tester 125 AMP**

- Extremely handy and portable way to load test suspected low charging batteries
- Internal 125 AMP loading capacity. Digital voltage indicator with LED battery status
- Tests 12-volt batteries on or off the vehicle. Load safety switch prevents arcing
- Features extra-heavy nickel-plated ventilated case, heavy-duty cable, copper-plated clamps, and load safety switch to prevent arcing
- 1-year warranty; Repair or replace at discretion of repair center

BATTERY TESTERS AND BOOSTER CABLES



KTI74500
Economy
12' Battery Booster Cables
250 AMP - 10 Gauge

- Durable rubber booster cables that resist extreme temperatures, oil and chemicals
- Light-duty
- 1-year limited warranty



KTI74510
Heavy-duty
16' Battery Booster Cables
400 AMP - 6 Gauge

- KTI's durable rubber booster cables resist extreme temperatures, oil and chemicals, and meet or exceed all SAE standards
- Sixteen foot heavy-duty cables include side/top clamps and 6 gauge wires with 400 AMP clamps
- 1-year limited warranty



KTI74505
Medium-duty
12' Battery Booster Cables
250 AMP - 8 Gauge

- KTI's durable rubber booster cables resist extreme temperatures, oil and chemicals, and meet or exceed all SAE standards
- Twelve foot medium-duty cables include side/top clamps and 8 gauge wires with 250 AMP clamps
- 1-year limited warranty



KTI74530
Professional
25' Battery Booster Cables
500 AMP - 2 Gauge

- KTI's durable rubber booster cables resist extreme temperatures, oil and chemicals, and meet or exceed all SAE standards
- Twenty-five foot professional cables include parrot-jaw clamps and 2 gauge wires with 500 AMP clamps
- 1-year limited warranty



KTI74524
20' Heavy Duty
4 Gauge 400 Amp Clamps

- Booster cables have a tangle-free design
- Flexible to -40° Fahrenheit temperatures
- Vinyl coated clamps help prevent rust and corrosion
- For side and top battery post



KTI74523
20' Heavy Duty
4 Gauge 500 Amp Clamps

- Booster cables have a tangle-free design
- Flexible to -40° Fahrenheit temperatures
- Vinyl coated clamps help prevent rust and corrosion
- For side and top battery post



KTI74521
Extra-Heavy-Duty 16' Battery Booster
Cables 400 AMP - 4 Gauge

- KTI's durable rubber booster cables resist extreme temperatures, oil and chemicals, and meet or exceed all SAE standards
- Sixteen foot extra-heavy-duty cables include side/top clamps and 4 gauge wires with 400 AMP clamps
- 1-year limited warranty

BATTERY TESTERS AND BOOSTER CABLES



KTI74308 **Automotive OBD2** **Connector - Computer** **Memory Saver**

- KTI's OBDII Memory Saver retains a vehicle's electronic memory presets (radio, GPS, seats and accessories) while the vehicle battery is disconnected
- OBDII cord connects to any 12V portable power source
- Memory Saver will not interfere with the vehicle's fault codes
- A visual LED indicator illuminates when cord is properly connected to power source to ensure no loss of electronic memory due to improper connection
- An extra-long 8-foot cord makes it easy to use on any vehicle
- 1-year limited warranty



KTI74536 **400 Amp Booster Cable** **Replacement Clamps**

- Vinyl coated clamps help prevent rust and corrosion
- Sold in pairs



KTI74537 **500 Amp Booster Cable** **Replacement Clamps**

- Vinyl coated clamps help prevent rust and corrosion
- Sold in pairs



KTI74538 **800 Amp Booster Cable** **Replacement Clamps**

- Vinyl coated clamps help prevent rust and corrosion
- Sold in pairs



KTI74535 **Booster Cable** **Replacement Clamps** **500 AMP Parrot Jaw**

- Replacement side terminal extension cable clamps for professional grade booster cables
- Sold in pairs



KTI01651 **Battery Clips** **30 Amp - Qty 2**



KTI70220 **Battery Terminal** **Cleaner**

- All metal battery terminal cleaner promotes longer battery life

KTI01611
10 Amp Alligator Clips - Qty 2



KTI02411
Battery Terminal
Top Mount - Qty 2



KTI02421
Battery Terminal
Side Mount - Qty 2



KTI02431
Battery Terminal
Heavy Duty Side Mount - Qty 2



KTI02441
Battery Terminal
Heavy Duty Top Mount - Qty 2



KTI02451
Battery Terminal
Heavy Duty
Top Mount Marine - Qty 2



KTI02461
Battery Terminal
Side Mount
Charging Post - Qty 2



KTI02471
Battery Terminal
Side Mount
Adapters - Qty 2



KTI02481
Battery Terminal
Side Mount
Charging Post Extenders - Qty 2



KTI02491
Battery Terminal
Side Mount
Battery Bolt 3/8" - Qty 2



KTI02511
Battery Bolt and Nut 3/8" - Qty 2





VEHICLE SPECIALTY



1.800.762.6002 | www.ktoolinternational.com

Vehicle Specialty | Flaring Tools



KT170081

Professional Brake Flaring Tool

- Easily form 45-degree double, single and bubble flares in OE steel, stainless steel, and soft metal tubing
- Use with 3/16"-, 1/4"-, 5/16"- and 3/8"-diameter lines
- All the brake-flaring forming dies are mounted right on the turret
- T-handle screw clamp securely holds line in place during forming
- Vise-mounted
- 1-Year Warranty



KT170082

Hydraulic Flaring Tool Kit

- Create precision 45 degree double, single and bubble flares in seconds
- Brake flaring tool works with stainless steel, steel, and soft metal tubing
- Use for brake lines, transmission cooler lines, and fuel lines
- Kit contains: brake flare forming tool, 3/16" and 1/4" tube retaining dies, adapters, handle, user manual, and storage/carrying case

Hydraulic flaring tool kit can be used for brake lines, transmission cooling lines and fuel lines. Works with stainless steel, steel and soft metal tubing.

Warranty: 1 year on material and workmanship

LIFETIME WARRANTY*



KT170085

ISO Flaring Tool

- Creates an ISO flare on brake lines without removing them from the vehicle
- Works on mild steel tubing (1.0 mm wall thickness)
- Packaged in blow-molded case • Weight: 2.8 lbs.

Kit includes yoke assembly, flaring bar, gauge/wrench and four adapters (4.75 mm 6 mm, 8 mm and 10 mm).

R LIFETIME WARRANTY*



KT170060

Double Flaring Tool

- Specially designed for double or single flare in copper, aluminum or soft steel brake line and brass tubing
- Includes seven adapters in sizes ranging from 3/16"-5/8"
- Packaged in blow-molded case
- Adapters available individually • Weight: 2.25 lbs.

KT170060-1 - Wing Nut

KT170061 - 3/16" Adapter

KT170062 - 1/4" Adapter

KT170063 - 5/16" Adapter

KT170064 - 3/8" Adapter

KT170065 - 7/16" Adapter

KT170066 - 1/2" Adapter

KT170067 - 5/8" Adapter

KT170068 - Flaring Press

KT170069 - Sizing Clamp



LIFETIME WARRANTY*

KT170080

Double Flaring Tool

- Professional double flare tool kit for fabricating double-compression lines (brake lines) or single-compression lines (fuel lines) in copper, steel, or aluminum
- Kit features high-grade, alloy steel center screw; plated, heat-treated, precision-ground swivel, and drop-forged, heat-treated yoke
- Each adapter is laser engraved for easy identification
- Packaged in a blow molded case

VEHICLE SPECIALTY

Vehicle Specialty | Brake

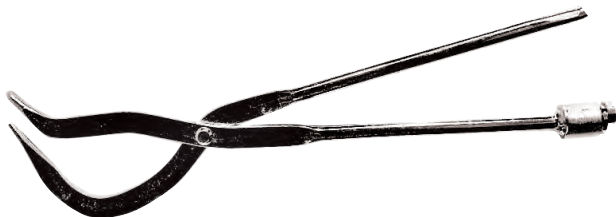

KT170131

Brake Spring Pliers

- For taking off and re-installing the heavy center springs

LIFETIME WARRANTY*



KT170132

Brake Spring Tool

- For taking off and re-installing the heavy center springs

LIFETIME WARRANTY*



KT122802

3-Piece Brake Service Torq Socket Set - 3/8" Drive

- Set includes T-40, T-45 and T-50 Torq bits
- Use on disc brake calipers to remove and install brake pads
- Bits are heat treated and precision machined

LIFETIME WARRANTY*

Set includes (also available individually):

KT122840 - T40 torq socket

KT122845 - T45 torq socket

KT122850 - T50 torq socket



KT127902

3-Piece Brake Caliper Hex Bit Set Metric - 3/8" Drive

- Set includes 7mm, 8 mm, 10 mm hex bits
- Use on disc brake calipers to remove and install brake pads
- Bits are heat treated and precision machined

Set includes (also available individually):

KT127907 - 7mm hex bit

KT127908 - 8mm hex bit

KT127910 - 10mm hex bit

LIFETIME WARRANTY*



KT122902

3-Piece Brake Caliper Hex Bit Set SAE - 3/8" Drive

- Set includes 1/4", 5/16", 3/8" hex bits
- Use on disc brake calipers to remove and install brake pads
- Bits are heat treated and precision machined

Set includes (also available individually):

KT122908 - 1/4" hex bit

KT122910 - 5/16" hex bit

KT122912 - 3/8" hex bit

LIFETIME WARRANTY*



KT170163

Disc Brake Piston tool

- Rotates pistons back into brake calipers when replacing brake pads on vehicles with rear wheel disc brakes
- Provides 6-drive pin configurations to fit most Chrysler, Ford and GM cars and light trucks
- 3/8" square drive

LIFETIME WARRANTY*





KTI72261
Automotive Test and Bleed Kit

- Brake bleeder and auto tune-up kit
- Allows a single technician to quickly and cleanly bleed automotive brake and hydraulic clutch systems
- Technician can get answers to hundreds of automotive diagnostic and mechanical tests
- Powerful piston-style pump features a one-finger trigger vacuum release patented contoured molded grip and durable, lightweight, non-corrosive PVC construction
- Integrated diaphragm-style gauge displays Hg and kpa units and can be easily read by either right- or left-handed users
- 1 Year Warranty on material and workmanship

Kit contains pump and all components needed for one-person operation.



KTI70816
Digital Disc Brake Caliper 0-6"

- Digital display from 0-6" (150 mm)
- Accuracy to plus/minus .001" (0.1 mm)
- Stainless steel construction and shockproof
- Thumb wheel for accuracy and ease of use
- English/metric readout

LIFETIME WARRANTY*



Brake Bleeder Screws / Copper Washers		
Part #	Description	Qty
KTI04033	Brake Bleeder Screws Ford Truck 3/8-24 Long	5
KTI04034	Brake Bleeder Screws GM, Ford, Chrysler Cars 3/8-24	5
KTI04035	Brake Bleeder Screws GM Cars 1/16-24	5
KTI04036	Brake Bleeder Screws GM Cars M10 x 1.0	5
KTI04037	Brake Bleeder Screws Chevy, Chrysler, Import Cars M10 x 1.0	5
KTI04038	Brake Bleeder Screws Ford Truck 7/16-20	5
KTI04039	Brake Bleeder Screw Repair Insert 1/4-18 NPT	5
KTI04039R	Brake Bleeder Screw Repair Insert 1/8-27 NPT	5
KTI04040	Brake Bleeder Copper Washers 29/64 I.D. - 11/16 O.D.	5
KTI04041	Brake Bleeder Copper Washers 25/64 I.D. - 5/8 O.D.	5
KTI04042	Brake Bleeder Copper Washers 7/16 I.D. - 13/16 O.D.	5

VEHICLE SPECIALTY



KT100001 27 Piece Metric Brake Adapter Kit

- Multi-compartment plastic storage case
- Includes wide range of products
- Contains product assortment map
- Easily moves from job to job

This 27-piece kit contains components ranging in nine different sizes: F-3/16" M-M 10 x 1.0; F-3/16" M-M 11 x 1.0; F-3/16" M-M 12 x 1.0; F-3/16" M-M 13 x 1.0; F-3/16" 4.762 (3/16") M-M 10 x 1.25; F 3/16" (M10 x 1.0) M-M 13 x 1.5; F 3/16" (M10 x 1.0) M-M 11 x 1.5; and F 3/16" (M10 x 1.0) M-M 12 x 1.5.

KT100002 20 Piece Master Cylinder Adapter Assortment

- Multi-compartment plastic storage caseIncludes wide range of products
- Contains product assortment mapIncludes most popular sizes
- Easily moves from job to job



This 20-piece kit contains components ranging in nine different sizes: F-3/16" M-M 10 x 1.0; F 3/16" (M10 x 1.0) M-M 13 x 1.5; F 3/16" (M10 x 1.0) M-M 11 x 1.5; and F 3/16" (M10 x 1.0) M-M 12 x 1.5.



KT100005 64 Piece Brake Line Fitting Kit

- Multi-compartment plastic storage case includes wide range of products
- Contains product assortment map
- Includes most popular sizes
- Easily goes from job to job

This 64-piece kit includes brake line nuts and brake line unions in standard and metric sizes: Brake Line Nut 3/16", Brake Line Nut 1/4", Brake Line Nut (Long) 3/16", Brake Line Nut (Long) 1/4", Brake Line Nut 5/16", Brake Line Union 3/16", Brake Line Union 1/4", Brake Line Union 5/16", Metric Brake Line Nut 10mm x 1.0 Standard Flare, Metric Brake Line Nut 10mm x 1.0 Bubble Flare, Metric Brake Line Nut 3/8"-24 Bubble Flare, Metric Brake Union Nut 3/8"-24 for 7802 Nut, Metric Brake Union Nut 3/8"-24 for 7801 Nut, Metric Brake Union Nut 10mm x 1.0 for 7800 Nut.



KT100047 95 Piece Brake Line Fittings Assortment

- A general assortment of tubes nuts, unions and adapters
- Fittings include applications for British, European and Japanese systems
- Brake fitting assortments make it easy for any repair shop to keep the most popular fittings on hand and organized
- Save time and increase productivity
- Packaged in a refillable, multicompartament case featuring an easy-to-use product identification map



KTI00006
30 Piece Brake Bleeder Screw and Washer Assortment

- Multi-compartment plastic storage case
- Includes wide range of product
- Contains product assortment map
- Includes most popular sizes
- Easily goes from job to job

Kit Includes Brake Bleeder Screws and Brake Bleeder Copper Washers in different sizes: Brake Bleeder Screws Ford Truck 3/8-24 Long, Brake Bleeder Screws GM, Ford Chrysler Cars 3/8-24, Brake Bleeder Screws GM Cars 1/16-24, Brake Bleeder Screws GM Cars M10 x 1.0, Brake Bleeder Screws Chevy, Chrysler, Import Cars M10 x 1.0, Brake Bleeder Screws Ford Truck 7/16-20, Brake Bleeder Screw Repair Insert 1/8-27 NPT, Brake Bleeder Copper Washers 29/64 I.D. 11/16 O.D., Brake Bleeder Copper Washers 25/64 I.D. 5/8 O.D., Brake Bleeder Copper Washers 7/16 I.D. 13/16 O.D.



KTI00048
86-piece Master Brake Fittings Assortment

- Consists of 20 different types of tube nuts and unions
- Works on most import and domestic brake lines
- Fittings include application for British, European and Japanese vehicles



KTI00049
3/16" Master Fittings Assortment

- Master Brake Line Assortment plus 25' length of 3/16" copper-nickel brake line



KTI00050
3/16-1/4" Master Fittings Assortment

- Master Brake Fitting Asst plus 25' length of 3/16" and 25' length of 1/4" copper-nickel brake line

VEHICLE SPECIALTY

Vehicle Specialty | Brake



Copper-nickel brake lines are easy to bend, corrosion resistant and provide an excellent flare seal.



PVF (poly vinyl fluoride) coated lines feature 30X corrosion resistance over plain galvanized lines. PVF coated lines provide significant protection against all road elements.

Brake Line - Copper Nickel / Galfan Coated / PVF Coated Quantity		
Part #	Description	Qty.
KT103970	Brake Line - Copper Nickel 3/16" - 25'	1
KT103971	Brake Line - Copper Nickel 1/4" - 25'	1
KT103963	Brake Line - Galfan Coated 3/16" x 25' Coil	1
KT103964	Brake Line - Galfan Coated 1/4" x 25' Coil	1
KT103965	Brake Line - Galfan Coated 5/16" x 25' Coil	1
KT103966	Brake Line - Galfan Coated 3/8" x 25' Coil	1
KT103967	Brake Line - PVF Coated 3/16" x 25' Coil	1
KT103968	Brake Line - PVF Coated 1/4" x 25' Coil	1
KT103969	Brake Line - PVF Coated 5/16" x 25' Coil	1



Galfan coated brake lines provide extended corrosion and abrasion resistance by combining a hot dip coat of the alloy Galfan with an aluminum rich epoxy top coat.

Brake Line Fittings		
Part #	Description	Qty.
KT104023	3/16" Brake Line Nut 3/8"-24 Short Thread Inverted Flare	5
KT104024	3/16" Brake Line Nut 3/8"-24 Long Thread Inverted Flare	5
KT104025	1/4" Brake Line Nut 7/16"-24 Short Thread Inverted Flare	5
KT104026	1/4" Brake Line Nut 7/16"-24 Long Thread Inverted Flare	5
KT104027	5/16" Brake Line Nut 1/2"-20 Thread Inverted Flare	5
KT104008	3/16" Brake Line Nut Metric 10mm x 1.0 (Jap) Inverted Flare	5
KT104009	3/16" Brake Line Nut Metric 10mm x 1.0 (Eur) Bubble Flare	5
KT104010	3/16" Brake Line Nut 3/8"-24 (Brit) Bubble Flare	5
KT103972	3/16" Brake Line Nut Metric 11mm x 1.5 Bubble Flare	5
KT103973	3/16" Brake Line Nut Metric 12mm x 1.0 Bubble Flare	5
KT103974	3/16" Brake Line Nut Metric 13mm x 1.5 Bubble Flare	5
KT103975	3/16" Brake Line Nut 9/16"-18 Inverted Flare	5
KT103976	1/4" Brake Line Nut Metric 12mm x 1.0 Bubble Flare	5
KT103977	3/16" Brake Line Nut Metric 10mm x 1.0 Long Inverted Flare	5
KT103978	3/16" Brake Line Nut Metric 10mm x 1.0 Bubble Flare	5
KT103979	3/16" Brake Line Nut 7/16"-24 Inverted Flare	5
KT103980	3/16" Brake Line Nut 1/2"-20 Inverted Flare	5
KT103984	6mm Brake Line Nut Metric 12mm x 1.0 Bubble Flare	5
KT103985	6mm Brake Line Nut Metric 14mm x 1.5 Bubble Flare	5





Brake Line Adapters		
Part #	Description	Qty
KT104000	Brake Master Cylinder Adapter 3/16" Male x 3/16" Female	5
KT104001	Brake Metric Adapter 3/16 (3/8"-24) Female Inv Flare x 10mm x 1.0 Male Bubble Flare	5
KT104002	Brake Metric Adapter 3/16 (3/8"-24) Female Inv Flare x 10mm x 1.0 Male Inv Flare	5
KT104003	Brake Metric Adapter 3/16 (3/8"-24) Female Inv Flare x 11mm x 1.5 Male Bubble Flare	5
KT104004	Brake Metric Adapter 3/16 (3/8"-24) Female Inv Flare x 12mm x 1.0 Male Bubble Flare	5
KT104005	Brake Metric Adapter 3/16 (3/8"-24) Female Inv Flare x M13 x 1.5 Bubble Inv Flare	5
KT104006	Brake Metric Adapter 3/16 (3/8"-24) Female Inv Flare x 10mm x 1.25 Male Bubble Flare	5
KT104011	Brake Master Cylinder Adapter 3/16 (3/8"-24) Female x 1/4 (7/16"-24) Male Inv Flare	5
KT104012	Brake Master Cylinder Adapter 1/4 (7/16"-24) Female Inv Flare x 3/16 (3/8"-24) Male Inv Flare	5
KT104013	Brake Master Cylinder Adapter 1/4 (7/16"-24) Female Inv Flare x 5/16 (1/2"-20) Male Inv Flare	5
KT104014	Brake Master Cylinder Adapter 3/16 (9/16"-18) Male Inv Flare x 1/4 Female (7/16"-24) Inv Flare	5
KT104015	Brake Master Cylinder Adapter 5/16 (1/2"-20) Male Inv Flare x 3/16 (3/8"-24) Female Inv Flare	5
KT104016	Brake Master Cylinder Adapter 3/16 (9/16"-20) Male Inv Flare x 3/16 (3/8"-24) Female Inv Flare	5
KT104017	Brake Master Cylinder Adapter 3/16 (9/16"-18) Male Inv Flare x 3/16 (3/8"-24) Female Inv Flare	5
KT104018	Brake Master Cylinder Adapter 3/16 (9/16"-18) Male Inv Flare x 3/16 (1/2"-20) Female Inv Flare	5
KT104019	Brake Master Cylinder Adapter 1/4 Male x 5/16 Female Inv Flare	5
KT104020	Brake Metric Adapter 11mm x 1.5 Male Bubble Flare x 3/16 (10mm x 1.0) Female Inv Flare	5
KT104021	Brake Metric Adapter 12mm x 1.0 Male Bubble Flare x 3/16 (10mm x 1.0) Female Inv Flare	5
KT104022	Brake Metric Adapter 13mm x 1.5 Male Bubble x 3/16 (10mm x 1.0) Female Inv Flare	5



Brake Line Unions		
Part #	Description	Qty
KT104029	3/16" Brake Line Union 3/8"-24 Inverted	5
KT104030	1/4" Brake Line Union 7/16"-24 Inverted	5
KT104031	5/16" Brake Line Union 1/2"-20 Inverted	5
KT104007	3/16" Brake Union British to British Line 3/8"-24 Bubble Flare	5
KT104028	3/16" Brake Union Euro to Euro Line M10 x 1.0 Bubble Flare	5
KT104032	3/16" Brake Union Japan to Japan Line M10 x 1.0 Inverted Flare	5

VEHICLE SPECIALTY

Vehicle Specialty | Tire & Wheel



KT189001

Digital Tire Inflator Gauge

- Rugged die-cast body and a range of 2 to 150 psi with 0.1 psi resolution
- Programmed to work with various units of measurement (psi/bar/kpa/kg/cm2) and works on TPMS equipped wheels
- Features include a large face LCD digital display, anti-oil rubber casting and ergonomic grip
- Boasts a dual head chuck and is accurate to within $\pm 1\% + 0.5\text{psi}$ at 100psi and $\pm 2\% + 0.5\text{psi}$ at 150psi
- Backlit monitor is powered by two replaceable 3V lithium batteries
- 1-year warranty; Repair or replace at discretion of repair center



Tire Inflator Gauge with Dual-head Chuck

- Pressure range from 10 to 120 lbs. shown in 2 lb. increments, 15" air hose with 1/4" female NPT, 6" chrome-plated dual-head chuck and 3/8" - 24 thread air inlet
- Inflator gauge boasts a weatherproof aluminum body with corrosion-resistant brass valve
- Rugged construction to withstand everyday use and abuse
- Two steel washers provide an air-tight seal
- Gauge and valve cartridges are replaceable
- Easy-to-read and easy-to-use, magnifying bubble lens allows full view of scale
- Angled tip makes it easy to inflate tires on trucks with dual wheels
- 1-year warranty; Repair or replace at discretion of repair center

KT189002 - Packaged in color box

KT189003 - Packaged in color slip card



KT171940

4-way Lugnut Wrench - Fractional

- Sizes: 11/16", 3/4", 13/16" and 7/8"
- Drop-forged and heat-treated for strength and durability.
- Cross design provides improved leverage and extra torque.

LIFETIME WARRANTY*



KT171980

4-way Lugnut Wrench - Metric

- Sizes: 17mm, 19mm, 21mm and 23mm
- Drop-forged and heat-treated for strength and durability.
- Cross design provides improved leverage and extra torque.

LIFETIME WARRANTY*



KT171930

57-Piece Tire Repair Kit

- Easily and quickly repair punctures in tubeless tires
- Components designed for professional use in rugged shop environments
- Used to repair tires on cars, trucks, RVs, motor homes and more
- Includes: 2 heavy duty zinc alloy T-handles; 2 Allen wrenches; 1 steel insertion needle; 1 steel spiral reamer; 1 50-pack 4" tire string plugs; 1 tube of tire plug lube all in a blow-molded carrying case

KT171931 - Replacement Steel Plunger with T-Handle

KT171932 - Replacement Steel Reamer with T-Handle

KT171933 - Replacement 4" Strip 50-pack

KT171934 - Replacement Tire Plug Lube

R

VEHICLE SPECIALTY

KTI33300 7-Piece 1/2" Drive Thin Wall

Protective Socket Set

- Sockets made of chrome moly steel
- Complete set comes in a handy plastic case
- Set includes: 17mm blue color, 19mm gold color, 21mm red color, 13/16" purple color, 7/8" green color, 1" titanium color, 1-1/16" black color



Set includes (also available individually):

KTI33317	Thin Wall Protective Socket	17mm	Blue
KTI33319	Thin Wall Protective Socket	19mm	Gold
KTI33321	Thin Wall Protective Socket	21mm	Red
KTI33326	Thin Wall Protective Socket	13/16"	Purple
KTI33328	Thin Wall Protective Socket	7/8"	Green
KTI33332	Thin Wall Protective Socket	1"	Titanium
KTI33334	Thin Wall Protective Socket	1-1/16"	Black

KTI33350 7-Piece 1/2" Drive Torque Extension Set

- For use with thin wall impact sockets.
- Prevent over torque of wheel nuts.
- Use with foreign or domestic cars and light trucks



LIFETIME WARRANTY*

Set includes (also available individually):

KTI33351	1/2" Drive Torque Extension	55 ft./lbs.	Red
KTI33352	1/2" Drive Torque Extension	65 ft./lbs.	Yellow
KTI33353	1/2" Drive Torque Extension	80 ft./lbs.	Green
KTI33354	1/2" Drive Torque Extension	100 ft./lbs.	Lt. Blue
KTI33355	1/2" Drive Torque Extension	120 ft./lbs.	White
KTI33356	1/2" Drive Torque Extension	140 ft./lbs.	Black
KTI33357	1/2" Drive Torque Extension	175 ft./lbs.	Orange

AccuTorq

ACC10-0314 4-Piece AccuTorq® Set Application: Ford

Set includes (also available individually):

ACC10-0308	Gray	1/2" drive	19mm	100 ft./lbs.
ACC10-0310	Light Brown	1/2" drive	21mm	80 ft./lbs.
ACC10-0311	Brown	1/2" drive	21mm	100 ft./lbs.
ACC10-0313	Turquoise	1/2" drive	7/8"	140 ft./lbs.



AccuTorq

ACC10-0315 4-Piece AccuTorq® Set Application: Cars, Vans and Light Trucks

Set includes (also available individually):

ACC10-0306	Yellow	1/2" drive	19mm	65 ft./lbs.
ACC10-0307	Blue	1/2" drive	19mm	80 ft./lbs.
ACC10-0308	Gray	1/2" drive	19mm	100 ft./lbs.
ACC10-0311	Brown	1/2" drive	21mm	100 ft./lbs.



LIFETIME WARRANTY*

LIFETIME WARRANTY*

ACC10-0317 5-Piece AccuTorq® Set

Set includes (also available individually):

ACC10-0305	Red	1/2" drive	17mm	80 ft./lbs.
ACC10-0307	Blue	1/2" drive	19mm	80 ft./lbs.
ACC10-0308	Gray	1/2" drive	19mm	100 ft./lbs.
ACC10-0310	Light Brown	1/2" drive	21mm	80 ft./lbs.
ACC10-0311	Brown	1/2" drive	21mm	100 ft./lbs.



LIFETIME WARRANTY*

LIFETIME WARRANTY*

ACC10-0319 9-Piece AccuTorq® Set

Set includes (also available individually):

ACC10-0304	Green	1/2" drive	17mm	55 ft./lbs.
ACC10-0305	Red	1/2" drive	17mm	80 ft./lbs.
ACC10-0306	Yellow	1/2" drive	19mm	65 ft./lbs.
ACC10-0307	Blue	1/2" drive	19mm	80 ft./lbs.
ACC10-0308	Gray	1/2" drive	19mm	100 ft./lbs.
ACC10-0310	Light Brown	1/2" drive	21mm	80 ft./lbs.
ACC10-0311	Brown	1/2" drive	21mm	100 ft./lbs.
ACC10-0312	White	1/2" drive	22mm	120 ft./lbs.
ACC10-0313	Turquoise	1/2" drive	7/8"	140 ft./lbs.





ACC10-0321

8-Piece

AccuTorq® Set

Set includes (also available individually):

ACC10-0304	Green	1/2" drive	17mm	55 ft./lbs.
ACC10-0305	Red	1/2" drive	17mm	80 ft./lbs.
ACC10-0306	Yellow	1/2" drive	19mm	65 ft./lbs.
ACC10-0307	Blue	1/2" drive	19mm	80 ft./lbs.
ACC10-0308	Gray	1/2" drive	19mm	100 ft./lbs.
ACC10-0310	Light Brown	1/2" drive	21mm	80 ft./lbs.
ACC10-0311	Brown	1/2" drive	21mm	100 ft./lbs.
ACC10-0313	Turquoise	1/2" drive	7/8"	140 ft./lbs.

LIFETIME WARRANTY*



ACC10-0324

5-Piece

AccuTorq® Set

Application: Ford

Set includes (also available individually):

ACC10-0308	Gray	1/2" drive	19mm	100 ft./lbs.
ACC10-0310	Light Brown	1/2" drive	21mm	80 ft./lbs.
ACC10-0311	Brown	1/2" drive	21mm	100 ft./lbs.
ACC10-0313	Turquoise	1/2" drive	7/8"	140 ft./lbs.
ACC10-0328	Charcoal	1/2" drive	21mm	147 ft./lbs.

LIFETIME WARRANTY*



ACC10-0326

6-Piece

AccuTorq® Set

Application: Ford

Set includes (also available individually):

ACC10-0308	Gray	1/2" drive	19mm	100 ft./lbs.
ACC10-0310	Light Brown	1/2" drive	21mm	80 ft./lbs.
ACC10-0311	Brown	1/2" drive	21mm	100 ft./lbs.
ACC10-0313	Turquoise	1/2" drive	7/8"	140 ft./lbs.
ACC10-0328	Charcoal	1/2" drive	21mm	147 ft./lbs.
ACC10-3898	Light Purple	1/2" drive	22mm	160 ft./lbs.

LIFETIME WARRANTY*



ACC10-0322

10-Piece

AccuTorq® Set

Set includes (also available individually):

ACC10-0304	Green	1/2" drive	17mm	55 ft./lbs.
ACC10-0305	Red	1/2" drive	17mm	80 ft./lbs.
ACC10-0306	Yellow	1/2" drive	19mm	65 ft./lbs.
ACC10-0307	Blue	1/2" drive	19mm	80 ft./lbs.
ACC10-0308	Gray	1/2" drive	19mm	100 ft./lbs.
ACC10-0310	Light Brown	1/2" drive	21mm	80 ft./lbs.
ACC10-0311	Brown	1/2" drive	21mm	100 ft./lbs.
ACC10-0312	White	1/2" drive	22mm	120 ft./lbs.
ACC10-0313	Turquoise	1/2" drive	7/8"	140 ft./lbs.
ACC10-3899	Light Green	1/2" drive	24mm	140 ft./lbs.

LIFETIME WARRANTY*



ACC10-0323

10-Piece

AccuTorq® Set

Set includes (also available individually):

ACC10-0327	Light Blue	1/2" drive	22mm	100 ft./lbs.
ACC10-0328	Charcoal	1/2" drive	21mm	147 ft./lbs.
ACC10-0329	Off White	1/2" drive	17mm	90 ft./lbs.
ACC10-0334	Light Yellow	1/2" drive	17mm	113 ft./lbs.
ACC10-0336	Orange	1/2" drive	22mm	75 ft./lbs.
ACC10-0340	Mud	1/2" drive	14mm	80 ft./lbs.
ACC10-0341	Quartz	1/2" drive	19mm	120 ft./lbs.
ACC10-0342	Light Tan	1/2" drive	19mm	90 ft./lbs.
ACC10-0343	Red Orange	1/2" drive	21mm	110 ft./lbs.
ACC10-3898	Light Purple	1/2" drive	22mm	160 ft./lbs.

LIFETIME WARRANTY*



VEHICLE SPECIALTY



ACC10-0450

4-Piece
AccuTorq® Set

Application: Deep Well Truck

Set includes (also available individually):

ACC10-0312	White	1/2" drive	22mm	120 ft./lbs.
ACC10-0313	Turquoise	1/2" drive	7/8"	140 ft./lbs.
ACC10-0328	Charcoal	1/2" drive	21mm	147 ft./lbs.
ACC10-3899	Light Green	1/2" drive	24mm	140 ft./lbs.



ACC10-0455

5-Piece

AccuTorq® Set

Application: Light Truck

Set includes (also available individually):

ACC10-0312	White	1/2" drive	22mm	120 ft./lbs.
ACC10-0313	Turquoise	1/2" drive	7/8"	140 ft./lbs.
ACC10-0328	Charcoal	1/2" drive	21mm	147 ft./lbs.
ACC10-3898	Light Purple	1/2" drive	22mm	160 ft./lbs.
ACC10-3899	Light Green	1/2" drive	24mm	140 ft./lbs.



ACC20-4100

4-Piece Heavy-duty
AccuTorq® Set
3/4" Drive



Set includes (also available individually):

ACC20-3918	Red	3/4" drive	1-1/4"	250 ft./lbs.
ACC20-3919	Brown	3/4" drive	33mm	475 ft./lbs.
ACC20-3920	Black	3/4" drive	1-1/2"	475 ft./lbs.
ACC20-3921	Yellow	3/4" drive	13/16"	475 ft./lbs.



ACC20-4000

4-Piece Heavy-duty
AccuTorq® Set
1" Drive



Set includes (also available individually):

ACC20-3908	Red	1" drive	1-1/4"	250 ft./lbs.
ACC20-3909	Brown	1" drive	33mm	475 ft./lbs.
ACC20-3910	Black	1" drive	1-1/2"	475 ft./lbs.
ACC20-3911	Yellow	1" drive	13/16"	475 ft./lbs.

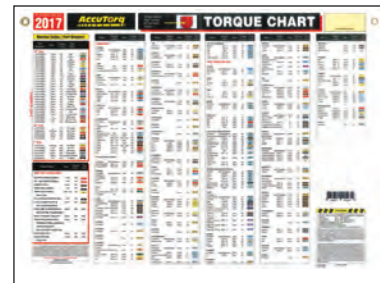

ACC10-0103

Torque Chart

Easy-to-read, color-coded torque chart. Lists applications for most foreign and domestic vehicles.



ACC2597Y1290

Empty Heavy Duty Case



ACC20-3100

4-Slot Heavy-Duty Storage Bracket

Heavy-duty wall bracket for convenient storage of heavy-duty torque sockets



ACC10-0100

5-Slot Storage Bracket

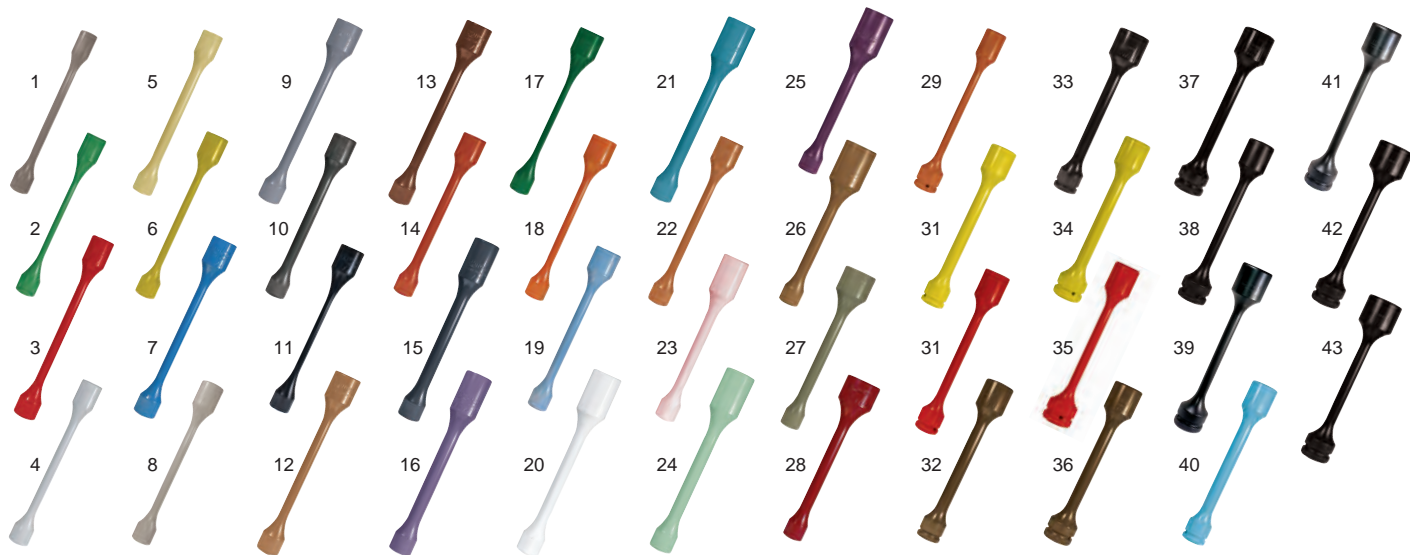

1/2" Drive			3/4" Drive		
Part #	Size/Torque Rating	Color	Part #	Size/Torque Rating	Color
ACC10-0340	14mm - 80 ft/lbs.	Mud (1)	ACC20-3904	1" - 175 ft/lbs. (Heavy-duty)	Orange (29)
ACC10-0304	17mm - 55 ft/lbs.	Green (2)	ACC20-3921	13/16" sq. - 475 ft/lbs. (Heavy-duty)	Yellow (30)
ACC10-0305	17mm - 80 ft/lbs.	Red (3)	ACC20-3918	1-1/4" - 250 ft/lbs. (Heavy-duty)	Red (31)
ACC10-0329	17mm - 90 ft/lbs.	Off White (4)	ACC20-3919	33mm - 475 ft/lbs. (Heavy-duty)	Brown (32)
ACC10-0334	17mm - 113 ft/lbs.	Light Yellow (5)	ACC20-3920	1-1/2" - 475 ft/lbs. (Heavy-duty)	Black (33)
ACC10-0306	19mm - 65 ft/lbs.	Yellow (6)	1" Drive		
ACC10-0307	19mm - 80 ft/lbs.	Blue (7)	Part #	Size/Torque Rating	Color
ACC10-0342	19mm - 90 ft/lbs.	Light Tan (8)	ACC20-3911	13/16" sq. - 475 ft/lbs. (Heavy-duty)	Yellow (34)
ACC10-0308	19mm - 100 ft/lbs.	Gray (9)	ACC20-3908	1-1/4" - 250 ft/lbs. (Heavy-duty)	Red (35)
ACC10-0335	19mm - 110 ft/lbs. - Deep Well	Purple	ACC20-3909	33mm - 475 ft/lbs. (Heavy-duty)	Brown (36)
ACC10-0341	19mm - 120 ft/lbs.	Quartz Gray (10)	ACC20-3910	1-1/2" - 475 ft/lbs. (Heavy-duty)	Black (37)
ACC10-0309	21mm - 60 ft/lbs.	Black (11)	ACC20-3045	30mm - 330 ft/lbs. (Heavy-duty)	Unpainted (38)
ACC10-0310	21mm - 80 ft/lbs.	Light Brown (12)	ACC20-3055	30mm - 400 ft/lbs.	Unpainted (39)
ACC10-0311	21mm - 100 ft/lbs.	Brown (13)	ACC20-3056	30mm - 400 ft/lbs. (Heavy-duty)	Light Blue (40)
ACC10-0343	21mm - 110 ft/lbs.	Red Orange (14)	ACC20-3345	33mm - 330 ft/lbs. (Heavy-duty)	Unpainted (41)
ACC10-0328	21mm - 148 ft/lbs.	Charcoal (15)	ACC20-3360	33mm - 440 ft/lbs. (Heavy-duty)	Unpainted (42)
ACC10-3898	21mm - 160 ft/lbs.	Light Purple (16)	ACC20-3913	33mm - 550 ft/lbs. (Heavy-duty)	Greyline
ACC10-0337	22mm - 60 ft/lbs.	Dark Green (17)	ACC20-3914	33mm - 550 ft/lbs. (Heavy-duty) Extended Depth	Greyline
ACC10-0336	22mm - 75 ft/lbs.	Orange (18)	ACC20-4155	41mm - 400 ft/lbs. (Heavy-duty)	Unpainted (43)
ACC10-0327	22mm - 100 ft/lbs.	Light Blue (19)	<p>Limiting Sockets Made of specially heat treated Swedish spring steel, making AccuTorq® the most accurate torque socket in the world. Patented AccuTorq® strobe marks stop turning at precisely the correct torque EVERY time. There is NO guess work and no recalibration. Solid one-piece construction of AccuTorq® automotive and commercial truck sockets eliminates the wide torque variances unavoidable with socket extensions and adapters. Features deep well sockets for those special applications where regular socket depth is just not enough. AccuTorq®'s ultrasonic inspection of EACH socket and its ISO 9001 quality certification of manufacturing processes, make it possible for each AccuTorq to come with a lifetime guarantee. Made in Sweden.</p>		
ACC10-0312	22mm - 120 ft/lbs.	White (20)			
ACC10-0313	22mm - 140 ft/lbs.	Turquoise (21)			
ACC10-0338	22mm - 110 ft/lbs.	Copper (22)			
ACC10-0339	22mm - 154 ft/lbs.	Pink (23)			
ACC10-3899	24mm - 140 ft/lbs.	Light Green (24)			
ACC20-3900	1" - 140 ft/lbs.	Purple (25)			
ACC20-3901	1-1/16" - 140 ft/lbs. (Medium-duty)	Tan (26)			
ACC20-3902	1-1/8" - 140 ft/lbs. (Medium-duty)	Olive (27)			
ACC20-3903	1-1/4" - 140 ft/lbs. (Medium-duty)	Burgundy (28)			

VEHICLE SPECIALTY

Vehicle Specialty I Steering & Suspension



KTI70300

Pulley Puller and Installer Set

- Complete set removes and installs most power steering and alternator pulleys on domestic vehicles
- Works with traditional V-shaped pulleys and serpentine belt system pulleys
- Packaged in blow-molded case
- Weight: 1.85 lbs



KTI70350

Long-Jaw Reversible Puller

- Five-ton reversible puller easily removes and installs pressed-on power steering, alternator and air pump pulleys
- Includes five-ton reversible puller that can be used as two or three-jaw puller in eight different combinations



KTI70330

Steering Wheel Puller

- Pulls steering wheels on most common makes of automobiles and light/medium duty trucks
- Tool designed to avoid damage to steering shaft threads
- Includes five sets of side bolts
- Made in the U.S.A.

KTI70348

Steering Wheel Puller

- Puller specially designed to prevent damage to steering shaft threads



KTI70360

Pitman Arm Puller

- Removes full-size Pitman arms from most cars and light trucks
- Features drop-forged frame and carbon-steel drive screw
- Opening: 1-5/16" (33 mm)
- Pull: 2-1/2" (64 mm)
- Weight: 1.85 lbs.



KTI70365

Pitman Arm Puller U.S.-Made

- Provides steady, smooth pull of a screw-type puller needed when tackling tougher, bigger jobs
- Features heat-treated center screw and heat-treated, alloy steel, heavy-duty yoke
- Weight: 2.1 lbs.



KTI70372

Universal Strut Spring Compressor

- Services a wide range of MacPherson struts without the need to use special adapter shoes
- Jaws are held in place by safety lock pins
- Tool can be driven by hand or with an impact wrench
- Compresses springs ranging from 4"-9" O.D. with wire diameters of 7/16"-11/16"
- Packaged in blow-molded storage case • Weight: 21 lbs.



KTI71519

Tie Rod End Tool

- Inexpensive and effective way to turn smooth tie rod ends
- Able to remove the inner tie rod without removing the outer tie rod
- Excellent for repairing rack seals
- Simply slide the tool over the end and tighten the collar to allow access with a 3/8" drive extension
- Fits most inner tie rods

LIFETIME WARRANTY*



KTI81995

Tie Rod Separator Air Chisel

- Pneumatic Bit, 21/32" Tie Rod Separator for .401 Shank Air Hammers

LIFETIME WARRANTY*



KTI81996

Ball Joint Separator Air Chisel

- 15/16" Ball Joint Separator for .401 Shank Air Hammers

LIFETIME WARRANTY*



LIFETIME WARRANTY*

KTI71556

Ball Joint Service Tool and Master Adapter Set

- For removing and replacing ball joints
- Remove and replace universal joints by using the C-Frame press
- Includes one live center forcing screw, receiver tubes, and removing/installing adapters
- Packaged in a red blow-molded case for storage and carrying

Ball joint service tool and master adapter contains: all new receiver tubes and removing/installing adapters required to work on a press-fit upper and lower ball joints on most Ford, GM, and Dodge 2 and 4 wheel drive pickups, vans and sport utility vehicles through 1997.

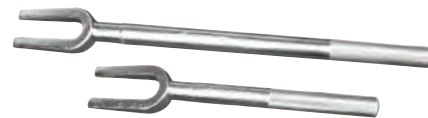

Tie Rod and Ball Joint Separators

LIFETIME WARRANTY*

KTI71501

- Use to replace worn out tie rods and separate shock absorber links
- Tine opening: 11/16" • Overall length: 15-3/4"

KTI71502

- Use to replace worn out ball joints and remove CV drive shafts on FWD vehicles
- Tine opening: 15/16" • Overall length: 11-3/4"

KTI71555

Ball Joint Master Service Adapter Set

LIFETIME WARRANTY*

- Kit includes all receiver tubes and removing/installing adapters needed to work on most GM, Ford and Dodge 2WD and 4WD pickups, vans and sport utility vehicles through 1997
- Works on press fit upper and lower ball joints



LIFETIME WARRANTY*

KTI71550

4-in-1 Ball Joint Service Set

- Removes and installs press fit parts, such as ball joints, universal joints and truck anchor pins without makeshift techniques
- Takes out even rusted and corroded parts
- Includes three receiver tubes (2-3/4" ID x 3" OD, 2-1/4" ID x 2-1/2" OD and 1-3/4" ID x 2" OD)



LIFETIME WARRANTY*

KTI70500

Heavy-duty 10 lb. Dent Puller Kit

- Kit contains 10 lb. slide hammer, two pipes (two-hole and hex nut), and chain with hook and five-plate puller attachments
- Packaged in blow-molded case



VEHICLE SPECIALTY

Vehicle Specialty I Steering & Suspension



KT170510 Slide Hammer Puller Kit

LIFETIME WARRANTY*

- Easily removes flange-type axles, oil seals, bearings and other press fit parts
- Includes: 5 lb. slide hammer; 8-function/3-jaw puller; 2-jaw puller; puller hook; rear axle puller; dent puller; and grip wrench adapter

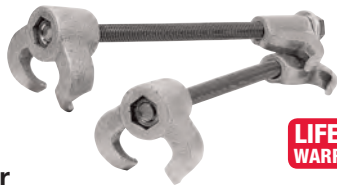

KT170370 MacPherson Strut Spring Compressor

LIFETIME WARRANTY*

- Works with most MacPherson strut assemblies to quickly assist in replacement of bent struts, strut tubes and damaged filters while on or off the vehicle
- Tool manufactured with Acme threaded screw for durability
- Fits most automobiles, but should not be used on GM "A," "C," "J" or "X" body cars
- Weight: 7 lbs.

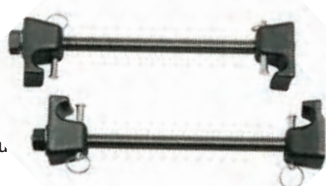

KT170371 MacPherson Heavy-Duty Strut Spring Compressor

LIFETIME WARRANTY*

- Works with most MacPherson strut assemblies to quickly assist in replacement of bent struts, strut tubes and damaged filters while on or off the vehicle
- Tool manufactured with Acme threaded screw for durability
- Fits most automobiles, but should not be used on GM "A," "C," "J" or "X" body cars
- Weight: 7 lbs.



KT170375 Coil Spring Compressor

LIFETIME WARRANTY*

- Single action tool boasts strong, steel jaws that securely hook into coil springs for their removal and installation
- Works with most domestic and some imported vehicles
- Should not be used on MacPherson struts
- Weight: 3.5 lbs.

Vehicle Specialty I Drive Shaft & Axle



KT170390 MEGAHAMMER® 3-Piece Set

- Saves time and money while servicing 3/4 and 1 ton Chevrolet and Dodge pickups with Dana axles
- Unique 4-6-8 bolt head will accommodate most trucks
- Removes seized hubs & rotors
- Eliminates damage removing captured rotors
- Cut the job in half



The MEGAHAMMER™ is the ultimate contender for all your tough jobs. A must have tool to service all 4 - wheel vehicles with captured rotors. Use it for: Rotor Replacement, Hub and Bearing Work, Axle Service, and Ball joint service.

Over the years rust and corrosion will build up and make removal of a seized bearing assembly almost impossible. Technicians are left with little recourse other than time consuming and labor-intensive measures to attempt to remove the seized bearing assembly. Most methods of removal employed today risk damaging the vehicle which in turn will increase repair costs.

The MEGAHAMMER™ tool's unique, patented design cuts repair time in half by employing a less labor-intensive process and greatly reduces the risks of damaging the vehicle. The size and capabilities of MEGAHAMMER™ make even the most formidable jobs seem easy. Many shops will not provide service to 4-wheel drive vehicles with captured rotors because of the costs and risks involved.

Replacement parts:

KT170395 - Replacement Slide and Stop Assembly

KT170396 - Replacement Hammer Assembly

1 YEAR WARRANTY*



CAUTION: Lock nut on hub removal tool must be tight to protect against thread damage. Slide shaft thread to be engaged into base late thread so it is flush with inside edge of base plate thread. Use countersunk holes ONLY for proper grip on studs. Use outboard support to help prevent tool and wheel assembly from dropping to floor. Do not stand behind tool when in use. Tool is heavy. Use extreme caution when lifting. Keep extremities clear of pinch points. Always wear eye protection when using hub removal tool. Locking pin must be in place when not in use. Not responsible for damage to vehicle.

WARNING: Please follow instructions carefully to reduce risk of personal injury or possible damage to the vehicle.

KTI70390KIT MEGAHAMMER® Hub Removal Kit

- Removes seized bearing assemblies and associated components from a vehicle chassis for maintenance and repair
- Minimizes cost and potential damage
- Compatible with 3/4- and 1-ton American made trucks with 4-, 6- or 8-bolt patterns

MEGAHAMMER kit includes 4-, 6-, and 8-bolt head, slide and stop assembly and hammer assembly. 38" length. This kit also contains a 5-bolt head for servicing 1/2-ton Ford, GM and Dodge trucks, 8-bolt head for servicing Ford Super Duty F250/F350 4x4 trucks, and 6-bolt head for use primarily with Dodge Durango and Chevy Trailblazer. It will however, accommodate any 6-bolt patterns with bolt circle diameters from 4" up to 6.75".



R

KTI70397 MEGAHAMMER® 4-Bolt Head

- Primarily for use with Honda vehicles with 4-bolt patterns
- Will fit 4-bolt patterns with bolt circle diameters from 4.2" up to 5.26"



KTI70391 MEGAHAMMER® 5-Bolt Head

- Services 1/2-ton Ford, GM and Dodge trucks
- 8" diameter, 17-1/2 lbs.



KTI70393 MEGAHAMMER® 6-Bolt Head

- For use primarily with Dodge Durango and Chevy Trailblazer
- It will, however, accommodate any 6-bolt patterns with bolt circle diameters from 4" up to 6.75"



KTI70392 MEGAHAMMER® 8-Bolt Head

- Services Ford Super Duty F250/F350 4x4 trucks
- 8" diameter, 28-1/2 lbs.



KTI70394 MEGAHAMMER® 4-, 6-, 8-Bolt Head

- Services 3/4- and 1-ton American made trucks with 4-, 6- or 8-bolt patterns
- 8" diameter, 17-1/2 lbs.

1 YEAR WARRANTY*



LIFETIME WARRANTY*

KTI70356 Pilot Bearing Slide Hammer

- Center rod spreads forged steel jaws, pushing them out against the bearing for quick and easy removal of bearings and other parts located in tight spaces
- Spread: 1/2" to 1-1/2"
- Weight: 3.7 lbs

LIFETIME WARRANTY*



KTI70343 Harmonic Balancer Installer

- Easily installs balancers and drive pulleys that are pressed on the crankshaft
- Includes eight threaded adapters: 7/16"-20; 1/2"-20; 9/16"-20; 5/8"-20; 3/4"-16; M12-1.5; M14-1.5; and M16-2.0
- Comes in a blow molded case
- Weight: 2.7 lbs.

LIFETIME WARRANTY*



KTI70382 Bearing Separator 0 to 4-1/4"

- Removes generator gears, bearing cones, bearings and similar parts that puller jaws cannot reach
- Designed to reduce risk of damage to part
- Flush knife-edge blades get behind work where most puller jaws cannot fit or grip
- Manufactured with high quality, heat treated steel. Spread: 0"-4-1/4"
- Threaded holes: 5/8"-18"

KTI70383 Puller and Bearing Separator 0 to 2-1/4"

- Removes generator gears, bearing cones, bearings and similar parts that puller jaws cannot reach
- Designed to reduce risk of damage to part
- Flush knife-edge blades get behind work where most puller jaws cannot fit or grip
- Manufactured with high quality, heat treated steel. Spread: 0"-2-1/4"
- Threaded holes: 3/8"-16"

LIFETIME WARRANTY*



KTI70384 Puller and Bearing Separator 0 to 4-1/4"

- Removes generator gears, bearing cones, bearings and similar parts that puller jaws cannot reach
- Designed to reduce risk of damage to part
- Flush knife-edge blades get behind where most puller jaws cannot fit or grip
- Manufactured with high quality, heat treated steel
- Spread: 0"-4-1/4"
- Threaded holes: 5/8"-18"

LIFETIME WARRANTY*



VEHICLE SPECIALTY

Vehicle Specialty I Engine Mechanical



LIFETIME WARRANTY*

Adjustable Oil Filter Wrenches

- Removes oil filters in hard to reach areas
- Tool features a swivel heat treated handle for easy access and durability and a unique yolk and link assembly for positive grip on filter

KTI73601 - Oil Filter Wrench Adjustable from 2-7/8" to 3-1/4"

KTI73602 - Oil Filter Wrench Adjustable from 3-7/16" to 3-3/4"

KTI73603 - Oil Filter Wrench Adjustable from 4" to 4-3/8"

KTI73605 - Oil Filter Wrench for Trucks Adjustable from 4-5/16" to 4-3/4"

KTI73606 - Oil Filter Wrench for Trucks Adjustable from 5-1/4" to 5-3/4"



LIFETIME WARRANTY*

KTI73600 4-in-1 Oil Filter Wrench

- Vinyl handle that provides strength and better grip, and swivel movement to clear obstructions
- A wide studded band prevents crushed filters
- Mechanics who demand a tough and durable product can count on the 4-in-1's stainless, plated and easily interchangeable steel bands
- Includes bands sized from 2-3/8"-4-3/8" (61 mm-111 mm)



LIFETIME WARRANTY*

KTI73730 Filter Wrench Nylon Strap

- Fits all oil, air and fuel spin-on filters up to 6" diameter
- Tool can be turned by a 1/2" square drive ratchet or a 3/4" open end wrench

KTI73731 Heavy-duty Filter Wrench Nylon Strap

- Designed for high torque requirements of truck filters
- Forged steel handle, and extra length, sturdy strapping
- A no-strip strap grips filters tightly
- Wrench adapts to spin filters up to 9"



LIFETIME WARRANTY*

LIFETIME WARRANTY*



KTI73620 Oil Filter Pliers

- Self adjusting spring action allows for a full range of filter applications
- Heavy-duty forged handles with textured grip for strength and leverage
- Use with 2-1/4" - 6" filters.



LIFETIME WARRANTY*

KTI73621 Spring Loaded Truck/Tractor Filter Plier

- Truck and tractor filter pliers are capable of removing all agricultural and construction equipment and automotive canister-type filters
- They are ideal for loosening over-tightened or seized filters, providing superior leverage for high-torque applications
- Spring-loaded truck and tractor filter pliers work on auto filters as well as Cummins diesel filters
- Forged jaws and extra teeth ensure a strong, sure grip - range 4" to 7"
- 17" extended-reach handles allow users to access the toughest areas



LIFETIME WARRANTY*

KTI73635 17 Piece Master Oil Filter Wrench Set

- 3/8" drive cap oil filter wrenches.
- Fits 95% of domestic and import automotive applications.
- Complete set comes in a handy 10" x 13" plastic case.
- Kit includes: 80mm 15 flutes, 82mm 15 flutes, 86mm 14 flutes, 65/67mm 14 flutes, 68mm 14 flutes, 73/74mm 14 flutes, 64/65mm 14 flutes, 74/76mm 15 flutes, 76mm 14 flutes, 93mm 15 flutes, 76mm 30 flutes, 86mm 16 flutes, 88.4mm 15 flutes, 93mm 36 flutes, 93mm 45 flutes, 96mm 18 flutes, 100mm 15 flutes.



Cap Filter Wrenches

Cap style design allows easy removal and installation from the end of the filter, even in tight locations. Use with 3/8" square drive.

LIFETIME WARRANTY*

KTI73607	Cap Filter Wrench 80mm 15-flute
KTI73608	Cap Filter Wrench 82mm 15-flute
KTI73609	Cap Filter Wrench 86mm 14-flute
KTI73610	Cap Filter Wrench 65/67mm 14-flute
KTI73611	Cap Filter Wrench 68mm 14 flute
KTI73612	Cap Filter Wrench 73/74mm 14 flute
KTI73613	Cap Filter Wrench 65mm 14 flute
KTI73613N	Cap Filter Wrench 64/65mm 14 flute
KTI73614	Cap Filter Wrench 74/76mm 15 flute
KTI73615	Cap Filter Wrench 76mm 14 flute
KTI73616	Cap Filter Wrench 93mm 15 flute
KTI73617	Cap Filter Wrench 76mm 30-flute
KTI73623	Cap Filter Wrench 86mm 16 flute
KTI73624	Cap Filter Wrench 88.4mm 15 flute
KTI73625	Cap Filter Wrench 93mm 36 flute
KTI73626	Cap Filter Wrench 93mm 45 flute
KTI73627	Cap Filter Wrench 96mm 18 flute
KTI73628	Cap Filter Wrench 100mm 15 flute

KTI73630 Oil Filter Wrench Toyota/Lexus

LIFETIME WARRANTY*

- Aluminum oil filter wrench
- 64.5mm diameter with 14 flutes
- Use with 3/8" square drive
- Fits Toyota, Lexus, Scion, Honda and Nissan filters

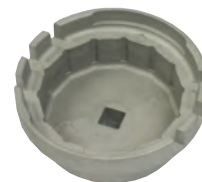

Works on several models including, Toyota: Avalon 05-08, Camry 07-09, RAV4 06-08, Sienna 07-08 3.5L, Tundra 07-08 5.7L, Corolla, Matrix 09-10, Scion CD 08-10, Truck 07-10 & Lexus: GS, IS, LC 06-10, ES, RX 07-10. Also fits the following filters: Honda filter #15400-PLM-A02 and Nissan filter #15208 65FOC.

Oil Filter Cap Sockets

LIFETIME WARRANTY*

Designed to handle a variety of applications, oil filter cap socket is rugged, laser marked and works even in confined areas. Use to remove housings with cartridge-type oil filters.



KTI73618 - Oil Filter Cap Socket 32mm

Applications: GM Ecotec 2.2L; Saturn: L-series (2001), Ion and Vue (2002-later); GM: Cavalier, Sunfire, Grand Am, Sonoma, S10, Allero (2002-later), Malibu (2002-2006); Pontiac: G6 and Solstice (2006); Chevrolet: HHR, Cobalt, Cobalt SS (2006); Saab: some models.

KTI73619 - Oil Filter Cap Socket 35/36mm

Applications: 6.0L Ford diesel; F250, F350, F450 pickups; Excursion.

KTI00009 60-Piece Drain Plug Gasket Kit Poly and Fiber

General purpose gasket kit includes the 7 most popular sizes of poly and fiber gaskets.



Part #	Description	Qty	Refill
KTI04134	1/2" Fiber Drain Plug Gasket	20	10
KTI04135	1/2" Poly Drain Plug Gasket	10	10
KTI04136	12mm Poly Drain Plug Gasket	10	10
KTI04137	14mm Poly Drain Plug Gasket	5	10
KTI04138	16mm Fiber Drain Plug Gasket	5	10
KTI04139	18mm Fiber Drain Plug Gasket	5	10
KTI04140	20mm Fiber Drain Plug Gasket	5	10

VEHICLE SPECIALTY

Vehicle Specialty I Engine Mechanical



Vacuum Caps

Part #	Description	Qty
KT104262	Vacuum Caps 3/16"	10
KT104263	Vacuum Caps 1/4"	10
KT104264	Vacuum Caps 5/16"	10
KT104265	Vacuum Caps 3/8"	10
KT104266	Vacuum Caps 1/8"	10



Vacuum Tees

Part #	Description	Qty
KT104240	Vacuum Tees 1/8-1/8-1/8	10
KT104241	Vacuum Tees 3/16-3/16-3/16	10
KT104242	Vacuum Tees 1/4-1/4-1/4	10
KT104243	Vacuum Tees 5/16-5/16-5/16	10
KT104245	Vacuum Tees 3/16-3/16-1/8	10
KT104247	Vacuum Tees 3/16-3/16-1/4	10
KT104251	Vacuum Tees 3/16 x 3/16	10
KT104252	Vacuum Tees 1/4 x 1/4	10
KT104253	Vacuum Tees 5/16 x 5/16	10
KT104260	Vacuum Tees 4-Way 3/16	10
KT104261	Vacuum Tees 5-Way 3/16	10



KT100058

40-Piece Drain Plug Assortment

Contains 12 of the most popular drain plugs which provides excellent coverage for most domestic and imported cars and light trucks. Application guide is included. Gaskets sold separately. Drain plug assortments make it easy for any repair shop to keep the most popular drain plugs on hand and organized.

Part #	Description	Qty	Refill
KT104120	Drain Plug 12mm-1.75 Pilot Point with Gasket	3	5
KT104121	Drain Plug 14mm-1.50 Pilot Point with Gasket	3	5
KT104123	Drain Plug 14mm-1.50 Pilot Point with Gasket	5	5
KT104124	Drain Plug 12mm-1.75 Pilot Point with Gasket	3	5
KT104126	Drain Plug 14mm-1.50 Pilot Point with Gasket	3	5
KT104188	Drain Plug 12mm-1.25 Standard Zinc	3	5
KT104189	Drain Plug 12mm-1.75 Pilot Point	3	5
KT104190	Drain Plug 14mm-1.50 Standard Zinc	3	5
KT104193	Drain Plug 1/2-20 Pilot Point with Gasket	3	5
KT104195	Drain Plug 14mm-1.50 Standard Zinc	3	5
KT104196	Drain Plug 14mm-1.50 Pilot Point	3	5
KT104198	Drain Plug 12mm-1.75 Pilot Point with Gasket	3	5



KT100059

27-Piece Drain Plug Assortment

Contains 9 popular oversize drain plugs and gaskets for the repair of stripped drain pan threads. Six sizes including single, double and triple oversize plugs. Includes fiber gaskets. Contains a total of 12 drain plugs and 15 gaskets.



Part #	Description	Qty	Refill
KT104125	Drain Plug M14-1.50 Single Oversize	2	5
KT104141	Fiber Gasket 1/2" Double Oversize	5	10
KT104142	Fiber Gasket 1/2" Single Oversize	5	10
KT104168	Fiber Gasket M14	5	10
KT104181	Drain Plug 1/2" Single Oversize	2	5
KT104182	Drain Plug 1/2" Double Oversize	2	5
KT104183	Drain Plug 1/2" Triple Oversize	2	5
KT104184	Drain Plug 1/2" Single Oversize Piggyback	2	5
KT104185	Drain Plug 1/2" Double Oversize Piggyback	2	5



KT100040

75-Piece Vacuum Tee Cap Kit

Small vacuum tee assortment kit includes five popular diameters for capping lines and hoses while testing emission control systems, vacuum lines, etc.. Contains 1/8", 3/16", 1/4", 5/16" and 3/8" diameter caps.

Part #	Description	Qty	Refill
KT104262	Vacuum Cap 3/16"	25	10
KT104263	Vacuum Cap 1/4"	10	10
KT104264	Vacuum Cap 5/16"	10	10
KT104265	Vacuum Cap 3/8"	5	10
KT104266	Vacuum Cap 1/8"	25	10



KT100042

56-Piece Vacuum Tee Kit

Entry level vacuum tee assortment includes 13 different sizes of tees. These hard connectors are used with the soft flexible tubing found on today's vehicles.

Part #	Description	Qty	Refill
KT104240	Vacuum Tee 1/8"x 1/8"x 1/8"	5	10
KT104241	Vacuum Tee 3/16"x 3/16"x 3/16"	5	10
KT104242	Vacuum Tee 1/4"x 1/4"x 1/4"	4	10
KT104243	Vacuum Tee 5/16"x 5/16"x 5/16"	3	10
KT104245	Vacuum Tee 3/16"x 3/16"x 1/8"	5	10
KT104247	Vacuum Tee 3/16"x 3/16"x 1/4"	4	10
KT104251	Vacuum Connector 3/16" x 3/16"	5	10
KT104252	Vacuum Connector 1/4" x 3/16"	5	10
KT104253	Vacuum Connector 5/16" x 3/16"	5	10
KT104260	Vacuum Tee 4-Way 3/16"	5	10
KT104261	Vacuum Tee 5-Way 3/16"	5	10
KT104262	Vacuum Cap 3/16"	5	10
KT104263	Vacuum Cap 1/4"	5	10



KT170380

Rear Axle Bearing Puller Kit



- Make easy work of removing semifloating rear axle bearings
- Set includes three sizes to service most domestic cars
- Use with standard slide hammer



KT170344

Harmonic Balancer Puller

- Pulls harmonic balancers on most automobiles
- Tool can be used on flywheels, gears, pulleys and other parts with tapped holes
- Includes five sets of side bolts
- Weight: 2.7 lbs.



KT170355

Pilot Bearing Puller

- Use to remove fly wheel pilot bearings up to 7-1/2" long in tight spaces where a slide hammer just won't fit
- Versatile tool also works as a bearing and bushing puller for generators and starters
- Spread: 1/2" to 1-1/2" I.D.
- Weight: 2.3 lbs.



VEHICLE SPECIALTY



KT170301

Reversible Puller 3"

2-Jaw 2-Ton 4" Spread 3-1/4" Reach

- Reversible jaws feature a wide face on one end and a narrow face on the other - it's like two tools in one
- Grip tightens as pressure is applied
- Tool manufactured with heat-treated, drop-forged, alloy steel
- Spread: 4" • Reach: 3-1/4"

LIFETIME WARRANTY*



KT170302

Reversible Puller 3" 2- or 3-jaw 2-ton 4-3/4" Spread 3-1/2" Reach

- Reversible jaws feature a wide face on one end and a narrow face on the other - it's like two tools in one
- Grip tightens as pressure is applied
- Tool manufactured with heat-treated, drop-forged, alloy steel
- Spread: 4-3/4". Reach: 3-1/2".

LIFETIME WARRANTY*



KT170303

Reversible Puller 4" 2-Jaw 5-Ton 6" Spread 3-1/4" Reach

- Reversible jaws feature a wide face on one end and a narrow face on the other - it's like two tools in one
- Grip tightens as pressure is applied
- Tool manufactured with heat-treated, drop-forged, alloy steel
- Spread: 6" • Reach: 3-1/4"

LIFETIME WARRANTY*



KT170304

Reversible Puller 4" 2- or 3-jaw 5-ton 7" Spread 3-1/4" Reach

- Reversible jaws feature a wide face on one end and a narrow face on the other - it's like two tools in one
- Grip tightens as pressure is applied
- Tool manufactured with heat-treated, drop-forged, alloy steel
- Spread: 7". Reach: 3-1/4".

LIFETIME WARRANTY*



KT170305

Reversible Puller 6" 2-Jaw 5-Ton 6" Spread 3-1/4" Reach

- Reversible jaws feature a wide face on one end and a narrow face on the other - it's like two tools in one
- Grip tightens as pressure is applied
- Tool manufactured with heat-treated, drop-forged, alloy steel
- Spread: 6" • Reach: 3-1/4"

LIFETIME WARRANTY*

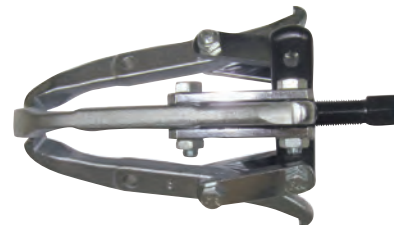

KT170306

Reversible Puller 6" 2- or 3-jaw 5-ton 6" Spread 3-1/4" Reach

- Reversible jaws feature a wide face on one end and a narrow face on the other - it's like two tools in one
- Grip tightens as pressure is applied
- Tool manufactured with heat-treated, drop-forged, alloy steel
- Spread: 6". Reach: 3-1/4".

LIFETIME WARRANTY*



KTI70311
Adjustable Puller 4"
2-jaw 2-ton 4" Spread 3-1/2" Reach

- Ideal for light duty gear pulling, such as electric motors and refrigeration applications
- Spread: 4". Reach: 3-1/2"
- Capacity: 2 tons.



KTI70313
Adjustable Puller 7"
2-jaw 5-ton 7" Spread 5-1/2" Reach

- Ideal for most medium duty gear pulling tasks
- Offers a wide range of reach. Spread: 7". Reach: 5-1/2". Capacity: 5 tons.

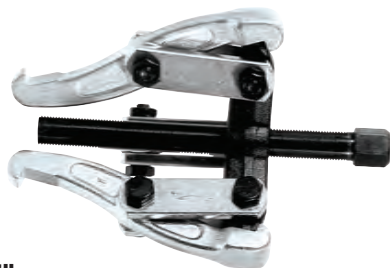

KTI70322
Reversible Puller 7"
2- or 3-jaw 5-ton 7" Spread 3-1/2" Reach

- Tool complete with versatile combination yoke that can be assembled to make either a 2-3 jaw puller
- Reversible jaws for internal or external pulls
- A 3-point pull provides extra power and stability when needed
- Spread: 7". Reach: 3-1/2". Capacity: 5 tons.



KTI70312
Adjustable Puller 6"
2-jaw 5-ton
6" Spread 3-1/2" Reach

- Ideal for most medium duty gear pulling tasks
- Designed for maximum utility
- Reversible jaws have a wide face on one end and a narrow face on the other
- Spread: 6". Reach: 3-1/2". Capacity: 5 tons.



KTI70321
Adjustable Puller 4"
3-jaw 2-ton 4" Spread 3-1/2" Reach

- Three jaws provide extra stability, making this puller ideal for light duty gear pulling applications
- Spread: 4". Reach: 3-1/2". Capacity: 2 tons.



KTI70323
Adjustable Puller 8"
2- or 3-jaw 5-ton 8" Spread 5-1/2" Reach

- Tool complete with versatile combination yoke that can be assembled to make either a 2-3 jaw puller
- A 3-point pull provides extra power and stability when needed
- Spread: 8". Reach: 5-1/2". Capacity: 5 tons.



VEHICLE SPECIALTY

LIFETIME WARRANTY*



KTI71100 Hose Pinch-off Pliers

- Eliminates the need to drain coolant when servicing cooling systems
- Pliers squeeze shut heater or radiator hoses
- Jaws swivel for parallel clamping
- Features automatic locking ratchet and can also be used with vacuum and fuel lines

KTI71103 2-Piece Flexible Line Clamp Set

- Squeezes heater, radiator, vacuum or any flexible hose to assist with repairs or problem diagnosis
- Clamps lock in place
- Set includes one large and one small clamp

Set includes (also available individually):

- KTI71105 - small
- KTI71106 - large



LIFETIME WARRANTY*

KTI71108 Specialty Hose Clamp Plier

- This dual purpose plier, with side jaw design allows hose clamps to be applied or removed in confined areas
- Pincers are held parallel to the hose



LIFETIME WARRANTY*

KTI75320 4-Piece Radiator Disconnect Tool Set

- Set includes 4 sizes to depress clips ranging from 5/8" to 1"
- Contains a GM-, Ford-, large- and extra-large radiator disconnect tools
- The tool is designed to completely fill the void in the connector to easily release the fastener
- Unique 40° offset design allows users to work around obstructions in tight spaces

Set includes (also available individually):

- KTI75321 - Ford Disconnect Removal Tool
- KTI75322 - GM Disconnect Removal Tool
- KTI75323 - Large Disconnect Removal Tool
- KTI75324 - X-Large Disconnect Removal Tool



LIFETIME WARRANTY*

KTI70600 Distributor Wrench

- Wrench is 3/8" drive and 1/2" x 9/16"



LIFETIME WARRANTY*

KTI70732 Tru-Grip Serpentine Belt Tool

- Clamping jaw allows user to position serpentine belt without the belt slipping from the tool's grip
- Tru-grip and long reach allows belt routing in limited-access areas
- Constructed of lightweight alloy steel for durability and strength
- Ergonomic handle for comfort and ease of use



LIFETIME WARRANTY*

KTI70720 Serpentine Belt Tool

- Removes and installs serpentine belts
- Releases tension on serpentine belts with spring loaded idler pulleys requiring a 15, 16 and 18 mm hex or 3/8 inch square drive
- Provides extra coverage for most applications



LIFETIME WARRANTY*

Set includes (also available individually):

- KTI70721 - Long Wrench
- KTI70722 - Short Wrench
- KTI70723 - 13MM U-Type Wrench
- KTI70724 - 14MM U-Type Wrench
- KTI70725 - 15MM U-Type Wrench
- KTI70726 - 15MM Socket
- KTI70727 - 16MM Socket
- KTI70728 - 18MM Socket

KTI70730 Stretch Belt Installation Tool

- Stretch belt installation tool is ideal for installing newer, patented Gates Micro-V Stretch Fit belts
- Stretch belts are found on many models of vehicles with drive systems that do not require a tensioner (i.e. power steering, air conditioning, water pumps)
- Installs belts without twisting or breaking internal belt fibers
- Durable construction features anodized aluminum body for corrosion resistance and a hardened steel pulley pivot

LIFETIME WARRANTY*



KTI70731 European Stretch Belt Installation Tool

- Stretch belt installation tool is ideal for installing stretch belts
- For use on vehicles with larger pulleys primarily found on European vehicles
- Stretch belts are found on many models of vehicles with drive systems that do not require a tensioner (i.e. power steering, air conditioning, water pumps)
- Installs belts without twisting or breaking internal belt fibers
- Durable construction features anodized aluminum body for corrosion resistance and a hardened steel pulley pivot

LIFETIME WARRANTY*



KT100071

150-piece Hitch Pin Assortment

- Assortment includes 150 hitch pins in six popular sizes from 5/32" x 2-15/16" to 3/32" x 1-3/16"
- Manufactured with chrome plated spring steel



Description	Qty	Description	Qty
5/32" x 2-15/16"	8	5/64" x 1-9/16"	25
9/64" x 1-3/4"	20	5/64" x 1-15/16"	30
7/64" x 1-5/8"	25	3/32" x 1-3/16"	42

KT100072

300-piece E-clip Assortment

- Assortment includes 300 pieces in 9 sizes from 1/16" to 7/8"



Description	Qty	Description	Qty
1/16"	30	1/2"	40
1/8"	30	5/8"	40
3/16"	40	3/4"	40
1/4"	50	7/8"	40
3/8"	50		

KT100075

555-piece Cotter Pin Assortment

- Assortment kit includes six popular sizes from 1/16" x 1" to 5/32" x 2-1/2"



Description	Qty	Description	Qty
1/16" x 1"	150	1/8" x 1-1/4"	75
3/32" x 1"	150	1/8" x 2"	50
3/32" x 1-1/2"	100	5/32" x 2-1/2"	30

10 Pack Blue A/C O-Rings

KT104458 - Air Conditioning O-Rings (Blue) - Qty 10

KT104471 - Air Conditioning O-Rings Compressor Switch Port/Oil Plug - Qty 10

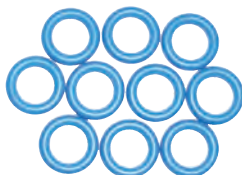

KT100078

144-piece Cotter Pin Assortment

- Assortment kit includes six popular products in six different sizes, ranging from 1/8" x 2" to 5/16" x 2-1/2"



Description	Qty	Description	Qty
1/8" x 2"	50	1/4" x 2"	20
5/32" x 2-1/2"	30	1/4" x 3"	16
3/16" x 3"	20	5/16" x 2-1/2"	8

KT100077

300-piece Snap Ring Assortment (18 different sizes)

- Assortment kit includes 300 pieces of six popular products in 18 different sizes, ranging from 1/8" to 1-1/4"



Description	Qty	Description	Qty
1/8"	20	1/2"	25
5/32"	10	1-1/8"	10
3/16"	15	9/16"	15
1/4"	25	5/8"	20
5/16"	15	3/4"	25
3/8"	20	13/16"	15
7/16"	15	7/8"	20
1-1/4"	5	1"	15
15/32"	15	1-1/16"	15

KT100084

170-piece U-clip and Screw Assortment

- 170-piece U-clip and screw assortment kit includes nine popular products in variety of sizes



Description	Qty	Description	Qty
#6 x 5/16" (3 x 8mm)	40	#6 (3mm) *large	20
#8 x 5/8" (4 x 16mm)	20	#8 (4mm)	20
#10 x 1/2" (5 x 13mm)	15	#10 (5mm)	15
1/4" x 3/4" (6 x 19mm)	10	1/4" (6mm)	10
#6 (3mm) *small	20		

VEHICLE SPECIALTY



KT100085 200-piece Hex Washer Drill Assortment

- Kit includes eight popular sizes, ranging from #8 x 3/4" to #10 x 1"

Description	Qty	Description	Qty
#8 x 3/4"	30	#10 x 1/2"	20
#8 x 1"	30	#10 x 5/8"	20
#8 x 1/2"	30	#10 x 3/4"	20
#8 x 5/8"	30	#10 x 1"	20



KT100086 270-piece HNBR O-Ring Assortment

- Includes wide variety of green O-rings in 18 sizes used in A/C applications

Description	Qty	Description	Qty
7/32" x 1/16" (5.29 x 1.78)	20	7/16" x 5/64" (11.00 x 2.00)	15
1/4" x 1/16" (6.07 x 1.78)	20	1/2" x 5/64" (12.00 x 2.00)	15
9/32" x 5/64" (6.80 x 1.90)	20	3/8" x 5/64" (10.00 x 2.00)	10
5/16" x 1/16" (7.65 x 1.78)	20	9/16" x 1/16" (13.90 x 1.80)	10
5/16" x 5/64" (7.80 x 1.90)	20	9/16" x 3/32" (13.95 x 2.62)	10
5/16" x 5/64" (8.00 x 2.00)	20	5/8" x 5/64" (15.00 x 2.00)	10
11/32" x 5/64" (8.80 x 1.90)	20	11/16" x 5/64" (17.00 x 2.00)	10
7/16" x 1/16" (10.82 x 1.78)	15	11/16" x 1/16" (17.17 x 1.78)	10
7/16" x 3/32" (10.77 x 2.62)	15	11/16" x 1/8" (17.04 x 3.53)	10



KT100089 110-piece Copper Washer Assortment

- Kit includes six popular products, ranging from 1/4" to 5/8"

Description	Qty	Description	Qty
1/4"	30	7/16"	15
5/16"	25	1/2"	10
3/8"	20	5/8"	10

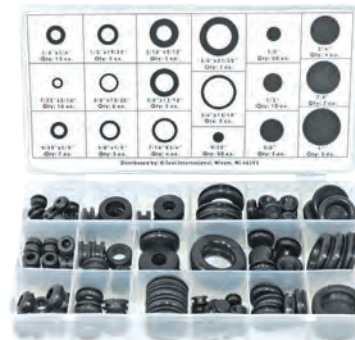

KT100091 125-piece Grommet Assortment

- Kit includes 18 popular products, ranging from 1/8" x 1/4" to 1"

Description	Qty	Description	Qty
1/8" x 1/4"	15	5/8" x 31/32"	3
7/32" x 5/16"	10	3/4" x 15/16"	2
9/32" x 1/2"	7	9/32"	20
1/2" x 19/32"	3	3/8"	20
3/8" x 15/32"	6	1/2"	10
3/8" x 1/2"	5	5/8"	5
5/16" x 9/16"	3	3/4"	4
3/8" x 13/16"	3	7/8"	3
7/16" x 3/4"	4	1"	2



KT100095
419-piece Metric
O-ring Assortment

- Huge assortment includes 32 different products, ranging in size from 3mm to 50mm ID

Description	Qty	Description	Qty
3mm x 1.5mm	20	20mm x 3.5mm	10
4.4mm x 2mm	20	22mm x 3.5mm	10
5mm x 2mm	18	23.5mm x 3.5mm	10
7mm x 1.5mm	23	25mm x 3.5mm	10
10mm x 1.5mm	23	26.5mm x 3.5mm	10
13mm x 1.5mm	23	28mm x 3.5mm	10
10mm x 2.5mm	14	30mm x 3.5mm	10
11mm x 2.5mm	13	31mm x 3.5mm	10
13mm x 2.5mm	14	33mm x 3.5mm	10
14mm x 2.5mm	13	34.5mm x 3.5mm	10
16mm x 2.5mm	14	36mm x 3.5mm	10
18mm x 2.5mm	14	38mm x 3.5mm	10
19mm x 2.5mm	13	41mm x 3.5mm	10
21mm x 2.5mm	14	44mm x 3.5mm	10
22mm x 2.5mm	13	47mm x 3.5mm	10
18mm x 3.5mm	10	50mm x 3.5mm	10

KT100093
120-piece
Roll Pin Assortment

- 120-piece roll pin assortment kit includes 30 of the most popular sizes



KT100094
407-piece Universal
O-ring Assortment

- 407-piece universal O-ring kit. Huge assortment includes 32 different products, ranging in size from 1/8" to 2" ID and 1/4" to 2-1/4" OD

Description	Qty	Description	Qty
1/8" x 1/4" x 1/16"	20	13/16" x 1-1/16" x 1/8"	10
3/16" x 5/16" x 1/16"	20	7/8" x 1-1/8" x 1/8"	10
1/4" x 3/8" x 1/16"	20	15/16" x 1-3/16" x 1/8"	10
5/16" x 7/16" x 1/16"	20	1" x 1-1/4" x 1/8"	10
3/8" x 1/2" x 1/16"	20	1-1/16" x 1-15/16" x 1/8"	10
1/2" x 5/8" x 1/16"	20	1-1/8" x 1-3/8" x 1/8"	10
3/8" x 9/16" x 3/32"	13	1-3/16" x 1-7/16" x 1/8"	10
7/16" x 5/8" x 3/32"	13	1-1/4" x 1-1/2" x 1/8"	10
1/2" x 11/16" x 3/32"	13	1-5/16" x 1-9/16" x 1/8"	10
9/16" x 3/4" x 3/32"	13	1-3/8" x 1-5/8" x 1/8"	10
5/8" x 13/16" x 3/32"	13	1-7/16" x 1-11/16" x 1/8"	10
11/16" x 7/8" x 3/32"	13	1-1/2" x 1-3/4" x 1/8"	10
3/4" x 15/16" x 3/32"	13	1-5/8" x 1-7/8" x 1/8"	10
13/16" x 1" x 3/32"	13	1-3/4" x 2" x 1/8"	10
7/8" x 1-1/16" x 3/32"	13	1-7/8" x 2-1/8" x 1/8"	10
3/4" x 1" x 1/8"	10	2" x 2-1/4" x 1/8"	10

Description	Qty	Description	Qty
5/32" x 5/8"	4	3/8" x 3/4"	2
5/32" x 1"	4	3/8" x 1-1/2"	2
5/32" x 1-1/2"	4	3/8" x 2"	2
1/4" x 5/8"	4	3/32" x 5/8"	4
1/4" x 1-1/4"	4	3/32" x 1"	4
1/4" x 1-3/4"	4	3/32" x 1-1/4"	4
5/64" x 1/4"	4	7/32" x 5/8"	4
5/64" x 1/2"	4	7/32" x 1-1/4"	4
5/64" x 1"	4	7/32" x 1-3/4"	4
1/16" x 3/16"	4	1/8" x 5/8"	4
1/16" x 5/16"	4	1/8" x 1"	2
1/16" x 3/4"	4	1/8" x 1-1/4"	2
5/16" x 3/4"	4	3/16" x 5/8"	2
5/16" x 1-1/2"	4	3/16" x 1"	4
5/16" x 2"	4	3/16" x 1-1/4"	4



VEHICLE SPECIALTY

Vehicle Specialty I Tubing, Cutting & Bending



KT172345

Tubing Bender Heavy-duty Pliers

- Bends 3/16", 1/4", 5/16" and 3/8" diameter copper and steel tubing without collapsing or kinking

LIFETIME WARRANTY*



LIFETIME WARRANTY*

KT172355

Ratcheting Hose and Pipe Cutter

- KT1's ratcheting hose and pipe cutting pliers accommodate a variety of materials up to 1-1/2" in diameter
- The ratcheting action makes cutting smooth and easy
- A one-touch, quick release lever opens pliers instantly
- Built-in clasp securely locks handles when not in use for added safety
- Cuts industrial air hose, multipurpose hose, heater and washer vacuum hose, non-metallic fuel line hose, PVC pipe, battery cables and much more
- Lifetime warranty

Replacement parts:

KT172355-1 - Replacement blade

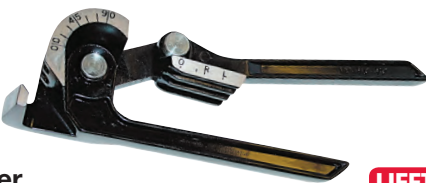

KT172340

Tubing Bender

- Bends 1/4", 5/16" and 3/8" aluminum, steel and copper tubing

LIFETIME WARRANTY*

KT170715

Universal Nut Splitter

- Medium Duty Nut Splitter
- Rugged drop forged frame
- Splits rusted or frozen nuts 1/8" to 15/16" across flats
- Parallel action of pusher cracks nuts on one side without damage to bolt threads
- Compound angle design with 360° rotating cutter allows use in difficult to reach locations



LIFETIME WARRANTY*

Cutters never touch the bolt. A few turns of power screw with a 3/4" hand wrench cuts nut for easy removal. Length: 6-1/4".



KT100022

Retainer Clip

Quick Disconnect Kit - 60 Piece

- 60-piece quick disconnect repair clip assortment kit includes parts for GM, Ford and Chrysler vehicles



Description	Qty	Description	Qty
GM/Chrysler/Ford 3/8"	5	Chrysler 5/16"	5
GM/Chrysler/Ford 5/16"	5	Ford 1/2"	5
Ford 5/16"	5	Ford 10.5mm	5
Ford 3/8"	5	Ford 13mm	5
Ford 1/4"	5	GM/Ford 5/8"	5
Ford 5/16"	5	GM 3/4"	5



KT172310

Tube Cutter Mini -

Range 1/8" to 5/8" OD

- Cuts 1/8" to 5/8" OD tubing
- Compact size for use in confined areas
- Features rollers to ease operation

LIFETIME WARRANTY*



KT172330

Tubing Cutter Heavy-duty

- Cuts 1/8" to 1-1/8" OD tubing
- Heavy-duty rollers smooth operation

LIFETIME WARRANTY*



KT172320

Tubing Bender - U.S.-made

- Bends 3/16", 1/4", 5/16" and 3/8" diameter tubing
- Features aluminum mandrel



LIFETIME WARRANTY*



Vehicle Specialty | Inspection



KT170900 Magnet Wire Flex Retriever Tool 8lb. Pull

- Retriever goes where human hands cannot
- Extendable magnet easily picks up and retrieves dropped items
- Tool features an ergonomic grip, a bendable shapeable wire flex shaft, powder-coated steel casings to reduce side pull, and a powerful, lightweight magnet to reach tight places
- Length: 21". Pull: 8 lbs.



**LIFETIME
WARRANTY***



KT170903 Magnet Telescopic Tool Straight 14lb. Pull

- Retriever goes where human hands cannot
- Extendable magnet easily picks up and retrieves dropped items
- Tool features an ergonomic grip, a telescopic shaft, powder-coated steel casings to reduce side pull, and a powerful, lightweight magnet to reach tight places
- Length: 6-1/2" to 32". Pull: 14 lbs.



**LIFETIME
WARRANTY***



KT170905 Magnet Telescoping Pocket Retriever 3.5lb. Pull

- Pocket size retriever features a telescoping shaft that extends from 5-1/4" to 24"
- Pull: 3-1/2 lbs.



**LIFETIME
WARRANTY***



KT170901 Magnet Swivel Head Telescopic Tool 14lb. Pull

- Retriever goes where human hands cannot
- Extendable magnet easily picks up and retrieves dropped items
- Tool features an ergonomic grip, a 180 swivel head, a telescopic shaft, powder-coated steel casings to reduce side pull, and a powerful, lightweight magnet to reach tight places
- Length: 6-1/2" to 32". Pull: 14 lbs.



**LIFETIME
WARRANTY***



KT170904 Magnet Telescopic Tool Straight 5lb. Pull

- Retriever goes where human hands cannot
- Extendable magnet easily picks up and retrieves dropped items
- Tool features an ergonomic grip, a telescopic shaft, powder-coated steel casings to reduce side pull, and a powerful, lightweight magnet to reach tight places
- Length: 6-1/2" to 32". Pull: 5 lbs.



**LIFETIME
WARRANTY***



KT170909 Super-duty Magnet Telescoping Tool Straight 30lb. Pull

- Super-duty retriever goes where human hands cannot
- Extendable magnet easily picks up and retrieves dropped items
- Tool features an ergonomic grip, a telescopic shaft, powder-coated steel casings to reduce side pull, and a powerful, lightweight magnet to reach tight places
- Length: 16" to 28". Pull: 30 lbs.



**LIFETIME
WARRANTY***

VEHICLE SPECIALTY



KT170910 Magnetic Pickup Tool

- Magnetic telescoping pickup tool extends from 5-1/4" to 22-3/4"
- Handy pocket-clip keeps the tool right at your fingertips!

**LIFETIME
WARRANTY***



KT170920 Mirror Glass Telescoping Tool Rectangular

- Tool goes where human eyes cannot
- Highly polished and protected mirror is attached to an expandable telescopic, ergonomic handle for user convenience
- Rectangular mirror measures 1-1/4" x 2-1/4". Length: 6-1/2" to 32".



**LIFETIME
WARRANTY***



KT170922 Mirror Glass Telescoping Tool Round

- Tool goes where human eyes cannot
- Highly polished and protected mirror is attached to an expandable telescopic, ergonomic handle for user convenience
- Round mirror measures 3-3/4". Length: 20" to 31"



**LIFETIME
WARRANTY***



KT170999 Magnetic Parts Dish Stainless Steel

- Keeps small parts from spilling. Round, non-rusting stainless steel dish measures 5-3/4" diameter



KT170915 Telescoping Pocket Magnet

- Extendable magnetic pickup tool extends from 13" to 20"
- Telescoping shaft is capable of lifting 3.5 pounds
- There isn't a lost nut or bolt this tool can't pick up!

**LIFETIME
WARRANTY***



KT170921 Mirror Glass Telescoping Tool Square

- Tool goes where human eyes cannot
- Highly polished and protected mirror is attached to an expandable telescopic, ergonomic handle for user convenience
- Square mirror measures 1-3/4" x 1-3/4"
- Length: 6-1/2" to 32"



**LIFETIME
WARRANTY***



KT170099 Two Way Radio

- 22 channels each with 38 privacy codes
- Up to 18 mile range
- Operating frequency 462.5625 MHz-462.7250 MHz
- Vox/DCM/Monitor/Scan/Squelch
- Roger beep & key tone on/off
- Adjustable volume control
- 5 ringing tones
- Key lock function
- Automatic battery save
- Ear/mic/charger jack
- Belt clip
- 1 Year Warranty on material and workmanship

Vehicle Specialty | Fuel



KTI75305 Mini Fuel Line Installation Tool

- Tool easily attaches all fuel line assemblies to original fuel lines
- Includes ratcheting 9/16" wrench
- Completely portable, moves from vehicle to vehicle
- Designed to fit in tight work areas

Warranty information: One-year warranty.

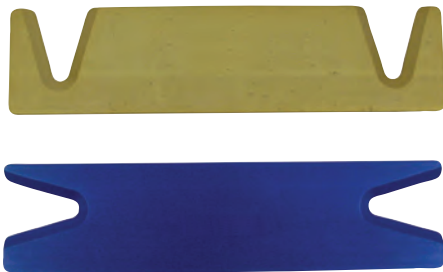

KTI75310 2-Piece Universal Fuel Line Disconnect Set

- Designed to remove stubborn fuel lines from high-tech cars and trucks
- Constructed of aircraft-grade aluminum for durability, yet makes them extremely lightweight and easy to use
- The low-profile design provides access to the tightest spaces
- The opening at the widest point is 3/4" and narrows to only 1/8"
- Set features a 90° fuel line disconnect tool and a straight fuel line disconnect tool

Set includes (also available individually):

KTI75311 - 90 Degree Universal Tool, from 1/8" to 3/4"

KTI75312 - Straight Universal Tool, from 1/8" to 3/4"



KTI04626 88-Piece Fuel Line Connector Assortment

- This kit contains everything you need to replace fuel line connectors on both steel and nylon line
- Assortment includes quick connectors (straight and 90°), brass connectors, compression unions, clamps, viton o-rings and connector removal tool

Part#	Description	Qty	Refill
KTI05100	Fuel Line Quick Connect Straight: F1/4 - M5/16	2	5
KTI05101	Fuel Line Quick Connect Straight: F5/16 - M5/16	2	5
KTI05102	Fuel Line Quick Connect Straight: F3/8 - M3/8	2	5
KTI05103	Fuel Line Quick Connect Straight: F5/16 - M3/8	2	5
KTI05104	Fuel Line Quick Connect Straight: F3/8 - M5/16	2	5
KTI05105	Fuel Line Quick Connect 90 Degree: F5/16 - M5/16	2	5
KTI05106	Fuel Line Quick Connect 90 Degree: F3/8 - M3/8	2	5
KTI05107	Fuel Line Quick Connect 90 Degree: F3/8 - M5/16	2	5
KTI05108	Fuel Line Quick Connect 90 Degree: F5/16 - M3/8	2	5
KTI05109	Fuel Line Connector Brass 1/4"	2	5
KTI05110	Fuel Line Connector Brass 5/16"	5	5
KTI05111	Fuel Line Connector Brass 3/8"	5	5
KTI05112	Brass Compression Union 1/4" Nylon to Nylon	2	5
KTI05113	Brass Compression Union 5/16" Nylon to Nylon	2	5
KTI05114	Brass Compression Union 3/8" Nylon to Nylon	2	5
KTI05115	Brass Compression Union 1/4" Nylon to Steel	2	5
KTI05116	Brass Compression Union 5/16" Nylon to Steel	2	5
KTI05117	Brass Compression Union 3/8" Nylon to Steel	2	5
KTI05118	Fuel Line Clamp 360 Degree 1/4"	5	10
KTI05119	Fuel Line Clamp 360 Degree 5/16"	10	10
KTI05120	Fuel Line Clamp 360 Degree 3/8"	10	10
KTI05186	Fuel System Connector Removal Tool 3/8" and 5/16"	1	5
KTI05257	Fuel Line Viton O-ring 3/8"	10	10
KTI05259	Fuel Line Viton O-ring 5/16"	10	10



**LIFETIME
WARRANTY***



VEHICLE SPECIALTY



KT175300 Fuel Line Quick Disconnect Press Kit

- Tool easily attaches fuel line (straight or 90°) connectors to OEM nylon fuel lines
- Includes four adapters
- Features large handle for smooth operation
- Can be moved from vehicle to vehicle or bench mounted

**LIFETIME
WARRANTY***

KT175306 Steel Line Stopper Kit

- Universal steel line stopper
- 5/16", 3/8", 1/2", and banjo fittings (10.4mm and 18mm)
- Suitable for clamping and sealing steel lines for all automotive fluids
- Provides an effective seal to steel lines when disconnected
- Prevents fluid loss and contamination of the work area



**LIFETIME
WARRANTY***



KT104627 Fuel Line Assortment with OEM

- 83-piece fuel line connector kit includes 24 different products for Ford, Chrysler and GM vehicles

Description	Qty	Description	Qty
Ford F1/4" M5/16"	2	All Vehicles Size 1/4"	2
GM/Chrysler/Ford F5/16" M5/16"	3	All Vehicles Size 5/16"	2
GM/Chrysler/Ford F3/8" M3/8"	3	All Vehicles Size 3/8"	2
Ford F5/16" M3/8"	2	All Vehicles Size 1/4"	2
GM/Chrysler/Ford F1/4" M5/16"	2	All Vehicles Size 5/16"	2
GM/Chrysler/Ford F3/8" M5/16"	2	All Vehicles Size 3/8"	2
GM/Chrysler/Ford F5/16" M5/16"	3	All Vehicles Size 1/4"	2
GM/Chrysler/Ford 3/8" M5/16"	2	All Vehicles Size 5/16"	2
GM/Chrysler/Ford F1/4" M3/8"	2	All Vehicles Size 3/8"	2
All Vehicles Size 1/4"	2	GM Size 5/16"	2
All Vehicles Size 5/16"	5	GM Size 3/8"	10
All Vehicles Size 3/8"	5	All Vehicles Size 5/16" & 3/8"	1



Fuel Line Quick Connect - Straight / 90-degree		
Part #	Description	Qty
KT105100	Fuel Line Quick Connect Straight: Female 1/4" - Male 5/16"	5
KT105101	Fuel Line Quick Connect Straight: Female 5/16" - Male 5/16"	5
KT105104	Fuel Line Quick Connect Straight: Female 3/8" - Male 5/16"	5
KT105103	Fuel Line Quick Connect Straight: Female 5/16" - Male 3/8"	5
KT105202	Fuel Line Quick Connect Straight: Female 5/16" - Male 3/8" Ford OE Style	5
KT105102	Fuel Line Quick Connect Straight: Female 3/8" - Male 3/8"	5
KT105124	Fuel Line Quick Connect Posi-Lock Straight Female 5/16" - Male 5/16"	5
KT105125	Fuel Line Quick Connect Posi-Lock Straight Female 3/8" - Male 3/8"	5
KT105105	Fuel Line Quick Connect 90-degree: Female 5/16" - Male 5/16"	5
KT105107	Fuel Line Quick Connect 90-degree: Female 3/8" - Male 5/16"	5
KT105108	Fuel Line Quick Connect 90-degree: Female 5/16" - Male 3/8"	5
KT105106	Fuel Line Quick Connect 90-degree: Female 3/8" - Male 3/8"	5
KT105126	Fuel Line Quick Connect Posi-Lock Bent Female 5/16" - Male 5/16"	5
KT105127	Fuel Line Quick Connect Posi-Lock Bent Female 3/8" - Male 3/8"	5



Fuel Line Retainer Clips		
Part #	Description	Qty
KT105375	Fuel Line Retainer Clip 3/8" GM	10
KT105376	Fuel Line Retainer Clip 5/16" GM	10
KT105377	Fuel Line Retainer Clip 5/16" Ford	10
KT105378	Fuel Line Retainer Clip 3/8" Ford	10
KT105379	Fuel Line Retainer Clip 1/4" Ford	10
KT105380	Fuel Line Retainer Clip 1/2" Ford	10
KT105381	Fuel Line Retainer Clip 10.5mm Ford Truck	10
KT105382	Fuel Line Retainer Clip 13mm Ford Truck	10
KT105383	Fuel Line Retainer Clip 5/16" Ford (White)	10
KT105384	Fuel Line Retainer Clip 3/8" Ford (Black)	10

VEHICLE SPECIALTY

Nylon Fuel Line

Part #	Description	Qty
KTI05205	Fuel System #12 Rated Nylon Fuel Line 1/4" - 25 Foot Roll	1
KTI05206	Fuel System #12 Rated Nylon Fuel Line 3/8" - 25 Foot Roll	1
KTI05207	Fuel System #12 Rated Nylon Fuel Line 5/16" - 25 Foot Roll	1



Fuel Sender Adapters

Part #	Description	Qty
KTI05370	Fuel Sender Adapter to Rubber Fuel Line Female 14mm to Male 5/16"	5
KTI05371	Fuel Sender Adapter to Rubber Fuel Line Female 16mm to Male 3/8"	5
KTI05226	Fuel Sender Adapter to Nylon Fuel Line Female 14mm to Male 5/16"	5
KTI05228	Fuel Sender Adapter to Nylon Fuel Line Female 16mm to Male 3/8"	5



Fuel Line Viton O-Ring

Part #	Description	Qty
KTI05257	Fuel Line Viton O-Ring 3/8" GM	2
KTI05259	Fuel Line Viton O-Ring 5/16" GM	2



Fuel Line Clamps

Part #	Description	Qty
KTI05118	Fuel Line Clamp 360° 1/4" for Nylon & Rubber Hose	10
KTI05119	Fuel Line Clamp 360° 5/16" (8mm) for Nylon & Rubber Hose	10
KTI05120	Fuel Line Clamp 360° 3/8" (10mm) for Nylon & Rubber Hose	10
KTI05177	Fuel System Fuel Injection Hose Clamps 1/4"	10
KTI05179	Fuel System Fuel Injection Hose Clamps 5/16" (8mm)	10
KTI05181	Fuel System Fuel Injection Hose Clamps 3/8" (10mm)	10



Fuel Filter Repair Lines

Part #	Description	Qty
KTI05225	Fuel Filter Repair Lines 180° 3/8" x 6-1/2" 16mm GM	5





Fuel Line Fittings		
Part #	Description	Qty
KTi05111	Fuel Line Connector Brass 3/8"	5
KTi05112	Brass Compression Union 1/4" Nylon to Nylon	5
KTi05113	Brass Compression Union 5/16" Nylon to Nylon	5
KTi05114	Brass Compression Union 3/8" Nylon to Nylon	5
KTi05115	Brass Compression Union 1/4" Nylon to Steel	5
KTi05116	Brass Compression Union 5/16" Nylon to Steel	5
KTi05117	Brass Compression Union 3/8" Nylon to Steel	5
KTi05109	Fuel Line Connector Brass 1/4"	5
KTi05110	Fuel Line Connector Brass 5/16"	2
KTi05111	Fuel Line Connector Brass 1/4"	5
KTi05159	Nylon Fuel Line Brass Splice Joiner 3/8"	1
KTi05165	Fuel System Rubber Hose Barbed Connector 3/16"	5
KTi05167	Fuel System Rubber Hose Barbed Connector 1/4"	5
KTi05169	Fuel System Rubber Hose Barbed Connector 5/16"	5
KTi05171	Fuel System Rubber Hose Barbed Connector 3/8"	5



Fuel System Adapters		
Part #	Description	Qty
KTi05136	Fuel System Adapter Steel to Rubber or Nylon Line 1/4"	5
KTi05138	Fuel System Adapter Steel to Rubber or Nylon Line 5/16"	5
KTi05141	Fuel System Adapter Steel to Rubber or Nylon Line 3/8"	5
KTi05143	Fuel System Adapter GM 14mm to 5/16" to Nylon or Rubber Line	5
KTi05145	Fuel System Adapter GM 16mm to 3/8" to Nylon or Rubber Line	5
KTi05149	Fuel System Adapter 3/8" Nylon to 3/8" Rubber	5

VEHICLE SPECIALTY

*except KTI05372, KTI05373 and KTI05374



Fuel Filter Line Repair Kits

Part #	Description	Qty
KTI05209	Steel Fuel Line Repair Kit w/14mm Fitting and O-ring 5/16 Line x 9" Length	5
KTI05211	Steel Fuel Line Repair Kit w/14mm Fitting and O-ring 5/16 Line x 18" Length	5
KTI05213	Steel Fuel Line Repair Kit w/14mm Fitting and O-ring 5/16 Line x 36" Length	5
KTI05215	Steel Fuel Line Repair Kit w/16mm Fitting and O-ring 3/8 Line x 9" Length	5
KTI05217	Steel Fuel Line Repair Kit w/16mm Fitting and O-ring 3/8 Line x 18" Length	5
KTI05219	Steel Fuel Line Repair Kit w/16mm Fitting and O-ring 3/8 Line x 36" Length	5
KTI05221	Steel Fuel Line Repair Kit w/Quick Disconnect 5/16" x 18 - GM/Ford	5
KTI05372	Nylon Fuel Line Repair Kit Straight 12" Length Female 3/8" x Male 5/16"	5
KTI05235	Nylon Fuel Line Repair Kit Straight 12" Length Female 3/8" x Male 3/8"	5
KTI05243	Nylon Fuel Line Repair Kit Straight 12" Length Female 5/16" x Male 5/16"	5
KTI05233	Nylon Fuel Line Repair Kit Straight 12" Length Female 5/16" x Male 3/8"	5
KTI05237	Nylon Fuel Line Repair Kit 90° 12" Length Female 3/8" to Male 3/8"	5
KTI05245	Nylon Fuel Line Repair Kit 90° 12" Length Female 5/16" to Male 5/16"	5
KTI05373	Nylon Fuel Line Repair Kit 90° 12" Length Female 3/8" x Male 5/16"	5
KTI05374	Nylon Fuel Line Repair Kit 90° 12" Length Female 5/16" x Male 3/8"	5
KTI05253	Fuel Line Nylon Splice 3/8 Line x 12" Long - GM/Ford/Chrysler	5
KTI05255	Fuel Line Nylon Splice 5/16 Line x 12" Long - GM/Ford/Chrysler	5



Vehicle Specialty I Electrical Service

KTI70750 Spark Plug Boot Plier

- Plier features insulated grips
- Overall length: 8"



LIFETIME WARRANTY*



KTI75201 Ford Triton Spark Plug Extractor Set

- KTI's spark plug extractor set is a must-have for servicing Ford Triton engines model year 2004 and later
- This set easily extracts frozen and broken off spark plug sleeves from cylinder heads without removing the actual heads
- A specially machined guide works with extra-long tap and extractor to ensure the job is done right
- Avoid engine damage by using the KTI spark plug porcelain extractor set (KTI75202) to remove broken porcelain before extracting spark plug sleeve

LIFETIME WARRANTY*

KTI73701 Universal Spark Plug Gap Tool

- Measures in increments of one thousandth from .020 through .100

LIFETIME WARRANTY*



KTI73701-50 - 50-piece bulk pack

KTI75202 Ford Porcelain Spark Plug Extractor Set

- KTI's spark plug porcelain extractor set works in conjunction with the KTI spark plug extractor set (KTI75201)
- It is a must-have set for servicing Ford Triton engines model year 2004 and later
- This set easily extracts broken porcelain from spark plug sleeves
- Set uses a special bonding agent to extract porcelain from spark plug sleeve without pushing on the broken plug and potentially pushing it into the cylinder causing engine damage
- Meets Ford TSB specifications

LIFETIME WARRANTY*



Specialty Sockets - 3/8" Drive

Spark Plug Sockets:

6-point with rubber plug holder, hex top for wrench in tight areas.

KTI22221 - 5/8"
KTI22227 - 13/16"

6 PT



LIFETIME WARRANTY*

Flex Spark Plug Sockets:

Flex joint 3/8" drive, chrome plated, chrome vanadium steel, heat-treated.

KTI22521 - 5/8"
KTI22527 - 13/16"

6 PT



LIFETIME WARRANTY*

KTI22133 3/8" Drive "2-in-1" Oil Sender Socket

- For oil sending units or stoplight switch replacement

LIFETIME WARRANTY*



KTI32229 3/8" Drive Oxygen Sensor Socket

- Used to remove and install oxygen sensors on most domestic and some imported vehicles

LIFETIME WARRANTY*



Fuse Holders



Qty:

KTI01641 12 Gauge Fuse Holder for ATO Fuse 1
KTI01661 30 Amp Fuse Holder for AGC Fuse 2

KTI01671 Fuse Puller

Pull Auto, Glass and Mini Fuses



VEHICLE SPECIALTY



ATO Fuses/ATO Glo Fuses

- ATO fuses are color coded for amperage, have a recognizable body design, and standard footprint. ATO fuses snap into place without the need for special tools

Part #	Description	Qty
KT104209	3 Amp Fuses	5
KT104210	5 Amp Fuses	5
KT104211	7.5 Amp Fuses	5
KT104212	10 Amp Fuses	5
KT104213	15 Amp Fuses	5
KT104214	20 Amp Fuses	5
KT104215	25 Amp Fuses	5
KT104216	30 Amp Fuses	5



Part #	Description	Qty
KT104282	10 Amp Glo-Fuse	5
KT104283	15 Amp Glo-Fuse	5
KT104284	20 Amp Glo-Fuse	5
KT104285	25 Amp Glo-Fuse	5
KT104286	30 Amp Glo-Fuse	5



Mini Fuses / Low Profile Mini Fuses / Glo Mini Fuses



- The mini fuse style blade fuse is quickly becoming a new standard in the automotive industry
- The mini fuse allows for more circuits to be fused in the same space as either an ATO or ATC style fuse
- Mini fuses are offered in 2 to 30 amp current ratings

Part #	Description	Qty
KT104199	Fuses Mini 2 Amp	5
KT104200	Fuses Mini 3 Amp	5
KT104201	Fuses Mini 4 Amp	5
KT104202	Fuses Mini 5 Amp	5
KT104203	Fuses Mini 7.5 Amp	5
KT104204	Fuses Mini 10 Amp	5
KT104205	Fuses Mini 15 Amp	5
KT104206	Fuses Mini 20 Amp	5
KT104207	Fuses Mini 25 Amp	5
KT104208	Fuses Mini 30 Amp	5
KT104270	Low Profile Mini Fuse - 5 Amp	10
KT104271	Low Profile Mini Fuse - 7.5 Amp	10
KT104272	Low Profile Mini Fuse - 10 Amp	10
KT104273	Low Profile Mini Fuse - 15 Amp	10
KT104274	Low Profile Mini Fuse - 20 Amp	10
KT104275	Low Profile Mini Fuse - 25 Amp	10
KT104276	Low Profile Mini Fuse - 30 Amp	10
KT104277	Mini Glo-Fuse 10 Amp	5
KT104278	Mini Glo-Fuse 15 Amp	5
KT104279	Mini Glo-Fuse 20 Amp	5
KT104280	Mini Glo-Fuse 25 Amp	5
KT104281	Mini Glo-Fuse 30 Amp	5



Maxi Fuses		
Part #	Description	Qty
KT104234	Fuses Maxi 20 Amp	3
KT104235	Fuses Maxi 30 Amp	3
KT104236	Fuses Maxi 40 Amp	3
KT104237	Fuses Maxi 50 Amp	3
KT104238	Fuses Maxi 60 Amp	3
KT104239	Fuses Maxi 80 Amp	3



Glass Fuses

- Although still used in older-model cars, glass fuses are found primarily in automotive accessory applications today
- Glass fuses are widely used in electronic and electrical applications where proper fuse selection is critical to performance
- Sold as a package of 5

Part #	Description	Qty
KT100811	Fuses Glass 10 Amp	5
KT100821	Fuses Glass 15 Amp	5
KT100831	Fuses Glass 20 Amp	5
KT100841	Fuses Glass 25 Amp	5
KT100851	Fuses Glass 30 Amp	5
KT100861	Fuses Glass 5 Amp	5



Jcase Fuses		
Part #	Description	Qty
KT104220	Jcase Fuse - 20 Amp	5
KT104221	Jcase Fuse - 30 Amp	5
KT104222	Jcase Fuse - 40 Amp	5
KT104223	Jcase Fuse - 50 Amp	5
KT104224	Jcase Fuse - 60 Amp	5



Low Profile Jcase Fuses		
Part #	Description	Qty
KT104226	Low Profile Jcase Fuse - 20 Amp	5
KT104227	Low Profile Jcase Fuse - 25 Amp	5
KT104228	Low Profile Jcase Fuse - 30 Amp	5
KT104229	Low Profile Jcase Fuse - 40 Amp	5
KT104230	Low Profile Jcase Fuse - 50 Amp	5
KT104231	Low Profile Jcase Fuse - 60 Amp	5



KT100020

118-piece Master Plug-in Style Fuse Kit

- This comprehensive 118-piece assortment contains the most popular 24 numbers of plug-in fuses - ATO, ATM and MAXI

Part #	Size/Type	Qty	Refill
KT104199	2A mini plug-in fuse	5	5
KT104200	3A mini plug-in fuse	5	5
KT104201	4A mini plug-in fuse	5	5
KT104202	5A mini plug-in fuse	5	5
KT104203	7.5A mini plug-in fuse	5	5
KT104204	10A mini plug-in fuse	5	5
KT104205	15A mini plug-in fuse	5	5
KT104206	20A mini plug-in fuse	5	5
KT104207	25A mini plug-in fuse	5	5
KT104208	30A mini plug-in fuse	5	5
KT104209	3A plug-in fuse	5	5
KT104210	5A plug-in fuse	5	5
KT104211	7.5A plug-in fuse	5	5
KT104212	10A plug-in fuse	5	5
KT104213	15A plug-in fuse	10	5
KT104214	20A plug-in fuse	10	5
KT104215	25A plug-in fuse	5	5
KT104216	30A plug-in fuse	5	5
KT104234	20A maxi plug-in fuse	3	3
KT104235	30A maxi plug-in fuse	3	3
KT104236	40A maxi plug-in fuse	3	3
KT104237	50A maxi plug-in fuse	3	3
KT104238	60A maxi plug-in fuse	3	3
KT104239	80A maxi plug-in fuse	3	3



KT100021

Fuse Kit- ATO Fuse 80 Pieces

- 80-piece ATO fuse assortment kit includes ten each of eight popular sizes from 3 to 30 amp
 - Packaged in multicompartment, refillable plastic case
- Contains product assortment map for easy identification of components

Part #	Size	Qty	Refill
KT104209	3A plug-in fuse	10	5
KT104210	5A plug-in fuse	10	5
KT104211	7.5A plug-in fuse	10	5
KT104212	10A plug-in fuse	10	5
KT104213	15A plug-in fuse	10	5
KT104214	20A plug-in fuse	10	5
KT104215	25A plug-in fuse	10	5
KT104216	30A plug-in fuse	10	5



VEHICLE SPECIALTY



KT100080 120-Piece Auto Fuse Assortment (color-coded fuses)

- Kit includes auto fuses sized from 5A to 30A

Description	Qty	Description	Qty
5A Auto Fuses	20	20A Auto Fuses	20
10A Auto Fuses	20	25A Auto Fuses	20
15A Auto Fuses	20	30A Auto Fuses	20



KT100028 75-Piece Mini Fuse Kit

- Mini fuse kit contains 75 total pieces of 10 sizes including 2A, 3A, 4A, 5A, 7.5A, 10A, 15A, 20A, 25A and 30A fuses
- ATM mini fuses are used in many late-model OEM applications

Part #	Description	Qty	Refill
KT104199	2A mini fuse	10	5
KT104200	3A mini fuse	5	5
KT104201	4A mini fuse	5	5
KT104202	5A mini fuse	10	5
KT104203	7.5A mini fuse	5	5
KT104204	10A mini fuse	10	5
KT104205	15A mini fuse	10	5
KT104206	20A mini fuse	10	5
KT104207	25A mini fuse	5	5
KT104208	30A mini fuse	5	5

KT100081 120-Piece Mini Auto Fuse Assortment (color-coded fuses)

- Kit includes mini fuses sized from 2A to 30A



Description	Qty	Description	Qty
5A Auto Fuses	20	20A Auto Fuses	20
10A Auto Fuses	20	25A Auto Fuses	20
15A Auto Fuses	20	30A Auto Fuses	20

KT100082 56-Piece Maxi Auto Fuse Assortment (color-coded fuses)

- Includes maxi fuses sized from 20A to 100A



Description	Qty	Description	Qty
20A Auto Fuses	7	60A Auto Fuses	7
30A Auto Fuses	7	70A Auto Fuses	7
40A Auto Fuses	7	80A Auto Fuses	7
50A Auto Fuses	7	100A Auto Fuses	7

KT100027 16-Piece Maxi Fuse Kit

- Maxi fuse kit contains 16 pieces in the most popular 5 sizes including 20A, 30A, 40A, 50A and 60A
- Maxi fuses are used to protect circuits in the wiring harness - usually found under the hood, in a fuse panel or supplementary panel near the battery
- Primarily used in domestic cars, MAXI fuses also have some applications in imported models
- OEM applications currently range up to 60 amps, however, some aftermarket accessories require protection up to 80 amps



Part #	Description	Qty	Refill
KT104234	20A maxi plug-in fuse	3	10
KT104235	30A maxi plug-in fuse	4	10
KT104236	40A maxi plug-in fuse	4	10
KT104237	50A maxi plug-in fuse	3	10
KT104238	60A maxi plug-in fuse	2	10



KT100070
25-Piece ATO Glo-Fuse Assortment

- Finding open fuses is easy with these fuses that use LED technology to show that a fuse has opened - making them easy to spot in fuse panels tucked up under dark dashboards
- Same color coding and amp ratings as the ATO fuses
- Includes 25 pieces of the top 5 sizes including 10A, 15A, 20A, 25A and 30A

Part #	Description	Qty
KT104282	ATO Glo-Fuse 10 Amp	5
KT104283	ATO Glo-Fuse 15 Amp	5
KT104284	ATO Glo-Fuse 20 Amp	5
KT104285	ATO Glo-Fuse 25 Amp	5
KT104286	ATO Glo-Fuse 30 Amp	5



KT100068
30-Piece Low Profile Mini Fuse Assortment

- This is a low profile version of the ATM mini fuses
- Same color code and amp ratings
- Includes 30 pieces of the top 6 sizes - 7.5A, 10A, 15A, 20A, 25A and 30A

Part #	Description	Qty
KT104270	Low Profile Mini Fuse - 5 Amp	NA
KT104271	Low Profile Mini Fuse - 7.5 Amp	5
KT104272	Low Profile Mini Fuse - 10 Amp	5
KT104273	Low Profile Mini Fuse - 15 Amp	5
KT104274	Low Profile Mini Fuse - 20 Amp	5
KT104275	Low Profile Mini Fuse - 25 Amp	5
KT104276	Low Profile Mini Fuse - 30 Amp	5



KT100067
95-Piece AGC Glass Fuse Assortment

- These glass tube fuses are used in older-model cars and found primarily in automotive accessory applications
- Includes 95 total pieces of 6 popular sizes of AGC, AGW, SFE and GBC type fuses

Part #	Description	Qty
KT100811	10A glass fuse	10
KT100821	15A glass fuse	20
KT100831	20A glass fuse	20
KT100841	25A glass fuse	20
KT100851	30A glass fuse	20
KT100861	5A glass fuse	5



KT100069
25-Piece ATM Glo-Fuse Assortment

- Finding open fuses is easy with these fuses that use LED technology to show that a fuse has opened - making them easy to spot in fuse panels tucked up under dark dashboards
- Same color coding and amp ratings as the ATM mini blade fuses
- Includes 25 pieces of the top 5 sizes including 10A, 15A, 20A, 25A and 30A

Part #	Description	Qty
KT104277	ATM Glo-Fuse 10 Amp	5
KT104278	ATM Glo-Fuse 15 Amp	5
KT104279	ATM Glo-Fuse 20 Amp	5
KT104280	ATM Glo-Fuse 25 Amp	5
KT104281	ATM Glo-Fuse 30 Amp	5

VEHICLE SPECIALTY



KT100026 10-piece Jcase Fuse Assortment

- These high amp fuses are currently on many new domestic and Japanese model vehicles. Same color code and amp ratings
- Includes 10 pieces total of the most popular 5 sizes

Part #	Description	Qty	Refill
KT104220	Jcase Fuse - 20 Amp	2	5
KT104221	Jcase Fuse - 30 Amp	2	5
KT104222	Jcase Fuse - 40 Amp	2	5
KT104223	Jcase Fuse - 50 Amp	2	5
KT104224	Jcase Fuse - 60 Amp	2	5



KT100045 12-piece Low Profile Jcase Fuse Assortment

- This is the low profile version of the JCASE high amp fuses
- Same color code and amp ratings
- Includes 12 pieces total of the most popular 6 sizes

Part #	Description	Qty	Refill
KT104226	Low Profile Jcase Fuse - 20 Amp	2	5
KT104227	Low Profile Jcase Fuse - 25 Amp	2	5
KT104228	Low Profile Jcase Fuse - 30 Amp	2	5
KT104229	Low Profile Jcase Fuse - 40 Amp	2	5
KT104230	Low Profile Jcase Fuse - 50 Amp	2	5
KT104231	Low Profile Jcase Fuse - 60 Amp	2	5



KT100037 180-piece Solderless Terminal Kit

- Solderless terminal kit includes 180 pieces of the most popular terminal rings, spades, male and female disconnects and butt connectors

Part #	Description	Qty
KT104057	Ring Terminal Wire Size: 22-18 Stud Size: 10	10
KT104058	Ring Terminal Wire Size: 16-14 Stud Size: 6	10
KT104059	Ring Terminal Wire Size: 16-14 Stud Size: 10	10
KT104062	Ring Terminal Wire Size: 12-10 Stud Size: 10	10
KT104063	Ring Terminal Wire Size: 12-10 Stud Size: 1/4	10
KT104065	Spade Terminal Wire Size: 22-18 Stud Size: 10	10
KT104067	Spade Terminal Wire Size: 16-14 Stud Size: 10	10
KT104068	Ring Terminal Wire Size: 12-10 Stud Size: 10	10
KT104069	Butt Connector Wire Size: 22-18	10
KT104070	Butt Connector Wire Size: 16-14	10
KT104071	Butt Connector Wire Size: 12-10	10
KT104072	Male Slide Terminal Wire Size: 22-18 Tab Size: .250	10
KT104073	Female Slide Terminal Wire Size: 22-18 Tab Size: .250	10
KT104074	Male Slide Terminal Wire Size: 16-14 Tab Size: .250	10
KT104075	Female Slide Terminal Wire Size: 16-14 Tab Size: .250	10
KT104076	Male Slide Terminal Wire Size: 12-10 Tab Size: .250	10
KT104077	Female Slide Terminal Wire Size: 12-10 Tab Size: .250	10
KT104497	Ring Terminal Wire Size: 22-18 Stud Size: 6	10



KT100039 360-piece Professional Terminal Assortment

- Solderless terminal kit includes 24 of the top terminals including rings, spades, butt connectors, male and female slides, bullet terminals, 2-way and 3-way connectors



Part #	Description	Qty	Refill
KT104057	Ring Terminal Wire Size: 22-18 Stud Size: 10	20	10
KT104058	Ring Terminal Wire Size: 16-14 Stud Size: 6	20	10
KT104059	Ring Terminal Wire Size: 16-14 Stud Size: 10	20	10
KT104060	Ring Terminal Wire Size: 16-14 Stud Size: 1/4	10	10
KT104061	Ring Terminal Wire Size: 16-14 Stud Size 3/8	10	10
KT104062	Ring Terminal Wire Size: 12-10 Stud Size: 10	10	10
KT104063	Ring Terminal Wire Size: 12-10 Stud Size: 1/4	10	10
KT104064	Ring Terminal Wire Size: 12-10 Stud Size: 3/8	10	10
KT104066	Spade Terminal Wire Size: 16-14 Stud Size: 6	20	10
KT104067	Spade Terminal Wire Size: 16-14 Stud Size: 10	20	10
KT104068	Spade Terminal Wire Size: 12-10 Stud Size: 10	10	10
KT104069	Butt Connector 22-18	20	10
KT104070	Butt Connector 16-14	20	10
KT104071	Butt Connector 12-10	10	10
KT104074	Male Slide Terminal 16-14 Stud Size .250	20	10
KT104075	Female Slide Terminal 16-14 Stud Size .250	20	10
KT104078	Female Bullet 16-14 Stud Size .157	20	10
KT104079	Male Bullet 16-14 Stud Size .157	10	10
KT104080	3-Way 16-14	10	10
KT104081	2-way Female Bullet 16-14 .157	10	10
KT104082	Female Slide 16-14 Stud Size .250 Brass	20	10
KT104083	Male Slide 16-14 Stud Size .250 Brass	20	10
KT104084	Ins. Male Slide 16-14 Stud Size .250	10	10
KT104085	Ins. Female Slide 16-14 Stud Size .250	10	10

KT100087 360-piece Terminal Assortment

Kit contains 360 insulated PVC-sleeve, zinc-plated wire terminals and connectors. Essential for automotive, small-engine, appliance and electrical repair. Includes 13 of the most common wire connection sizes and styles.



Description	Qty	Description	Qty
10-32 ring 16-14 ga.	30	Butt connector 16-14 ga.	15
3/8" ring 16-14 ga.	20	Butt connector 12-10 ga	15
1/4" ring 16-14 ga.	20	Male bullet 16-14 ga.	10
10-32 ring 12-10 ga.	20	Female bullet 16-14 ga.	10
3/8" ring 12-10 ga.	15	Two-way line connector	10
1/4" ring 12-10 ga.	15	Male disconnect 18-14 ga.	10
10 spade 16-14 ga.	30	Female disconnect 18-14 ga.	10
10 spade 12-10 ga.	20	Male ins. disconnect 18-14	10
Butt connector 22-16 ga.	30	Female ins. disconnect 18-14	10



KT100038 120-piece Shrink Tube Solderless Terminal Kit

- Solderless terminal kit includes 24 popular terminal rings, spades, male and female disconnects, insulated slide terminals and butt connectors
- Heat shrink butt connectors make connections weatherproof

Part #	Description	Qty
KT104086	Ring Terminal 22-18 Stud Size 10	5
KT104087	Ring Terminal 16-14 Stud Size 6	5
KT104088	Ring Terminal 16-14 Stud Size 10	5
KT104089	Ring Terminal 12-10 Stud Size 10	5
KT104090	Ring Terminal 12-10 Stud Size 1/4"	5
KT104091	Ring Terminal 12-10 Stud Size 3/8"	5
KT104092	Spade Terminal 16-14 Stud Size 10	5
KT104093	Spade Terminal 12-10 Stud Size 10	5
KT104094	Butt Connector Heat Shrink 22-18	5
KT104095	Butt Connector Solder Seal 22-18	5
KT104096	Butt Connector Heat Shrink 16-14	5
KT104097	Butt Connector Solder Seal 16-14	5
KT104098	Butt Connector Heat Shrink 12-10	5
KT104099	Butt Connector Solder Seal 12-10	5
KT104100	Male Slide Terminal 22-18 Stud Size .250	5
KT104101	Female Slide Terminal 22-18 Stud Size .250	5
KT104102	Male Slide Terminal 16-14 Stud Size .250	5
KT104103	Female Slide Terminal 16-14 Stud Size .250	5
KT104104	Male Slide Terminal 12-10 Stud Size .250	5
KT104105	Female Slide Terminal 12-10 Stud Size .250	5
KT104106	Ins. Slide 16-14 Stud Size .250	5
KT104107	Ins. Slide 16-14 Stud Size .250	5
KT104108	Ins. Slide 12-10 Stud Size .250	5
KT104109	Ins. Slide 12-10 Stud Size .250	5

Electrical Solderless Terminals

Part #	Description	Qty
KTI04068	Electrical Solderless Terminals 12-10 #10 Spade	10
KTI04071	Electrical Solderless Terminals 12-10 Butt Connector	10
KTI04077	Electrical Solderless Terminals 12-10 Female Disconnect	10
KTI04109	Electrical Solderless Terminals 12-10 Female Full Insulated Weatherproof	5
KTI04076	Electrical Solderless Terminals 12-10 Male Disconnect	10
KTI04108	Electrical Solderless Terminals 12-10 Male Disconnect Full Insulated Weatherproof	5
KTI04063	Electrical Solderless Terminals 12-10, 1/4" Ring	10
KTI04064	Electrical Solderless Terminals 12-10, 3/8" Ring	10
KTI04062	Electrical Solderless Terminals 12-10 #10 Ring	10
KTI04066	Electrical Solderless Terminals 16-14 #6 Spade	10
KTI04067	Electrical Solderless Terminals 16-14 #10 Spade	10
KTI04081	Electrical Solderless Terminals 16-14 2-Way Snap Plug Receptacle	10
KTI04080	Electrical Solderless Terminals 16-14 3-Way Connector	10
KTI04070	Electrical Solderless Terminals 16-14 Butt Connector	10
KTI04075	Electrical Solderless Terminals 16-14 Female Disconnect	10
KTI04082	Electrical Solderless Terminals 16-14 Female Disconnect for Contact Body	10
KTI04084	Electrical Solderless Terminals 16-14 Female Disconnect Full Insulated	10
KTI04106	Electrical Solderless Terminals 16-14 Female Disconnect Full Insulated Weatherproof	5
KTI04074	Electrical Solderless Terminals 16-14 Male Disconnect	10
KTI04083	Electrical Solderless Terminals 16-14 Male Disconnect for Contact Body	10
KTI04085	Electrical Solderless Terminals 16-14 Male Disconnect Full Insulated	10
KTI04107	Electrical Solderless Terminals 16-14 Male Disconnect Full Insulated Weatherproof	5
KTI04079	Electrical Solderless Terminals 16-14 Universal Female Snap Plug	10
KTI04078	Electrical Solderless Terminals 16-14 Universal Snap Plug	10
KTI04060	Electrical Solderless Terminals 16-14, 1/4" Ring	10
KTI04061	Electrical Solderless Terminals 16-14, 3/8" Ring	10
KTI04058	Electrical Solderless Terminals 16-14 #6 Ring	10
KTI04059	Electrical Solderless Terminals 16-14 #10 Ring	10
KTI04057	Electrical Solderless Terminals 22-18 #10 Ring	10
KTI04065	Electrical Solderless Terminals 22-18 #10 Spade	10
KTI04497	Electrical Solderless Terminals 22-18 #6 Ring	10
KTI04069	Electrical Solderless Terminals 22-18 Butt Connector	10
KTI04073	Electrical Solderless Terminals 22-18 Female Disconnect	10
KTI04072	Electrical Solderless Terminals 22-18 Male Disconnect	10



KTI00631



KTI00641



KTI00611



KTI00621



KTI00651



KTI00661



KTIO0007

40-piece Copper Lug Terminal Assortment

- Copper lug terminal assortment kit includes five each of eight popular sized crimp-on copper lugs for use on 1 to 6 gauge wire
- Used for large cable applications like battery cables and grounding cables

Part #	Description	Qty	Refill
KTIO4049	Wire Size: 2 ga. Stud Size: 3/8"	5	10
KTIO4050	Wire Size: 4 ga. Stud Size: 3/8"	5	10
KTIO4051	Wire Size: 2 ga. Stud Size: 5/16"	5	10
KTIO4052	Wire Size: 4 ga. Stud Size: 5/16"	5	10
KTIO4053	Wire Size: 6 ga. Stud Size: 3/8"	5	10
KTIO4054	Wire Size: 1 ga. Stud Size: 3/8"	5	10
KTIO4055	Wire Size: 1 ga. Stud Size: 5/16"	5	10
KTIO4056	Wire Size: 6 ga. Stud Size: 5/16"	5	10



Electrical Copper Lugs		
Part #	Description	Qty
KTIO4054	Electrical Copper Lugs 1 Gauge x 3/8	10
KTIO4055	Electrical Copper Lugs 1 Gauge x 5/16	10
KTIO4049	Electrical Copper Lugs 2 Gauge x 3/8	10
KTIO4051	Electrical Copper Lugs 2 Gauge x 5/16	10
KTIO4050	Electrical Copper Lugs 4 Gauge x 3/8	10
KTIO4052	Electrical Copper Lugs 4 Gauge x 5/16	10
KTIO4053	Electrical Copper Lugs 6 Gauge x 3/8	10
KTIO4056	Electrical Copper Lugs 6 Gauge x 5/16	10



Electrical Shrink Tube Connectors / Terminals

Part #	Description	Qty
KTIO4098	Electrical Shrink Tube Butt Connector Heat Shrink 12-10	5
KTIO4096	Electrical Shrink Tube Butt Connector Heat Shrink 16-14	5
KTIO4094	Electrical Shrink Tube Butt Connector Heat Shrink 22-18	5
KTIO4099	Electrical Shrink Tube Butt Connector Solder Seal 12-10	5
KTIO4097	Electrical Shrink Tube Butt Connector Solder Seal 16-14	5
KTIO4095	Electrical Shrink Tube Butt Connector Solder Seal 22-18	5
KTIO4105	Electrical Shrink Tube Female Slide Terminal 12-10 Stud Size .250	5
KTIO4103	Electrical Shrink Tube Female Slide Terminal 16-14 Stud Size .250	5
KTIO4101	Electrical Shrink Tube Female Slide Terminal 22-18 Stud Size .250	5
KTIO4104	Electrical Shrink Tube Male Slide Terminal 12-10 Stud Size .250	5
KTIO4102	Electrical Shrink Tube Male Slide Terminal 16-14 Stud Size .250	5
KTIO4100	Electrical Shrink Tube Male Slide Terminal 22-18 Stud Size .250	5
KTIO4090	Electrical Shrink Tube Ring Terminal 12-10 Stud Size 1/4"	5
KTIO4089	Electrical Shrink Tube Ring Terminal 12-10 Stud Size 10	5
KTIO4091	Electrical Shrink Tube Ring Terminal 12-10 Stud Size 3/8"	5
KTIO4088	Electrical Shrink Tube Ring Terminal 16-14 Stud Size 10	5
KTIO4087	Electrical Shrink Tube Ring Terminal 16-14 Stud Size 6	5
KTIO4086	Electrical Shrink Tube Ring Terminal 22-18 Stud Size 6	5
KTIO4093	Electrical Shrink Tube Spade Terminal 12-10 Stud Size 10	5
KTIO4092	Electrical Shrink Tube Spade Terminal 16-14 Stud Size 10	5

VEHICLE SPECIALTY



KT100033 216-Piece Heat Shrink Tubing Assortment Set

- Protection and insulation of component and wires
- Color coordinated sizes
- Quick and simple to shrink by heat gun
- Shrink ratio 2:1
- Assortment includes sizes ranging from 2.5mm to 20mm

Description	Qty	Description	Qty
2.5mm x 45mm, Color black	50	6mm x 45mm, Color red	5
2.5mm x 45mm, Color red	20	10mm x 45mm, Color black	10
3.5mm x 45mm, Color black	30	10mm x 45mm, Color red	10
3.5mm x 45mm, Color red	15	13mm x 45mm, Color black	10
4.5mm x 45mm, Color black	20	13mm x 45mm, Color red	10
4.5mm x 45mm, Color red	10	20mm x 75mm, Color black	8
6mm x 45mm, Color black	10	20mm x 75mm, Color red	8



KT100035 85-piece Heat Shrink Tube Kit

- Shrink tube assortment kit includes five popular sizes
 - Ideal for weathertight seal of all electrical connections
 - Use for insulating, jacketing, bundling and identification
 - It is mechanically tough and has good abrasion and solvent resistance
 - Shrink temp - 250°F. Shrink ratio 2:1
- Kit contains five sizes (1/8", 3/16", 1/4", 3/8" and 1/2") for a total of 85 pieces

Part #	Description	Qty
KT102611	1/8" shrink tube	20
KT102621	3/16" shrink tube	20
KT102631	1/4" shrink tube	30
KT102641	3/8" shrink tube	10
KT104494	1/2" shrink tube	5



KT102651 Heat Shrink Tubing Assortment - Qty 8

- A high quality material which shrinks to 1/3 its size
 - It can be stored for extended periods of time without shrinkage
 - It remains flame retardant, and is very flexible
 - When heated, the sealant flows and physically encapsulates, creating a waterproof connection
- Includes (2) each of the following diameters: 1/8", 3/16", 1/4" and 3/8"

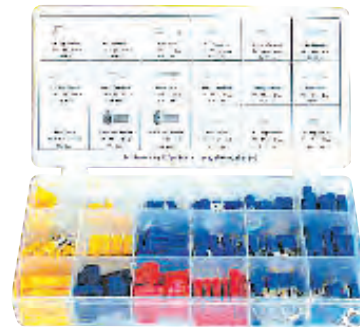

KT100097 157-piece Electric Wire Solderless Terminal Kit

- 157-piece electric wire solderless terminal kit includes 17 popular sizes for 10-18 gauge wire
- Products are color-coded for convenience

Description	Qty	Description	Qty
#8 ring terminal 16-14 ga.	11	Female connector 16-14 ga.	11
#10 ring terminal 16-14 ga.	11	Male connector 12-10 ga.	4
1/4" ring terminal 16-14 ga.	11	Female connector 12-10 ga.	4
5/16" ring terminal 12-10 ga.	8	Male bullet 16-14 ga.	11
3/8" ring terminal 12-10 ga.	4	Female bullet 16-14 ga.	11
Butt connect 22-18 ga.	11	#8 spade terminal 16-14 ga.	11
Butt connect 16-14 ga.	22	Quick splice and tap 16-14 ga	4
Butt connect 12-10 ga.	8	Quick splice and tap 22-18 ga	4
Male connector 16-14 ga.	11		



KT100034
105-Piece Dual-Wall
Heat Shrink Tubing Assortment Set

- Protection and insulation of component and wires
- Use for auto, marine, plane, home, industrial, computer, etc.
- Quick and simple to shrink by heat gun
- Waterproof; Shrink ratio: 3:1
- Assortment includes sizes ranging from 3.2mm to 25.4mm

Description	Qty
3.2mm x 45mm, Color black	28
3.2mm x 45mm, Color red	12
4.8mm x 45mm, Color black	16
4.8mm x 45mm, Color red	8
6.4mm x 45mm, Color black	7
6.4mm x 45mm, Color red	4
9.5mm x 45mm, Color black	6
9.5mm x 45mm, Color red	3
12.7mm x 75mm, Color black	5
12.7mm x 75mm, Color red	3
19.1mm x 75mm, Color black	3
19.1mm x 75mm, Color red	2
25.4mm x 75mm, Color black	4
25.4mm x 75mm, Color red	4



KT100003
100-piece Butt Connector Kit

- Vinyl solderless butt connector assortment kit includes three popular sizes for use on 10 to 22 gauge wire

Part #	Description	Qty
KT104069	Butt Connectors Vinyl 22-18 Gauge	20
KT104070	Butt Connectors Vinyl 16-14 Gauge	60
KT104071	Butt Connectors Vinyl 12-10 Gauge	20



KT107740
235-piece Heat Shrink Tube Kit

- 8 sizes, 3/32" to 3/4", 6" long
- 2:1 shrink ratio - inside diameter is measured before shrinking
- Heat rating: 257-degrees Fahrenheit (125-degrees Celsius)
- All sizes are provided in 6" lengths and can be cut to fit

Size: 1/8"	Qty	Size: 3/8"	Qty
Blue	11	Blue	2
Black	11	Black	2
Orange	11	Orange	2
Green	11	Green	2
Yellow	11	Yellow	2
Size: 3/32"	Qty	Size: 1/2"	Qty
Blue	8	Blue	2
Black	8	Black	2
Orange	8	Orange	2
Green	8	Green	2
Yellow	8	Yellow	2
Size: 3/16"	Qty	Size: 5/8"	Qty
Blue	11	Blue	1
Black	11	Black	1
Orange	11	Orange	1
Green	11	Green	1
Yellow	11	Yellow	1
Size: 1/4"	Qty	Size: 3/4"	Qty
Blue	11	Blue	1
Black	11	Black	1
Orange	11	Orange	1
Green	11	Green	1
Yellow	11	Yellow	1

VEHICLE SPECIALTY



KTI00004

60-piece Butt Connector Kit with Shrink Tube

- Vinyl butt with shrink fit connector assortment kit includes three popular sizes for use in many applications including automotive and marine
- Heat shrink butt connectors make connections weatherproof

Part #	Description	Qty
KTI04094	Butt Conn. Shrink Tubing 22-18Ga.	15
KTI04096	Butt Conn. Shrink Tubing 16-14Ga.	30
KTI04098	Butt Conn. Shrink Tubing 12-10Ga.	15



KTI56201

9" Professional Multi Purpose Crimper and Wire Stripper

- Wire cutter, bolt cutter, and wire stripper in one
- Crimps insulated and open barrel terminals

LIFETIME WARRANTY*

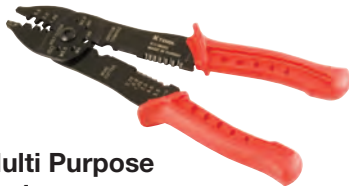

KTI56202

8.5" Professional Multi Purpose Crimper and Wire Stripper

- Wire cutter, bolt cutter, and wire stripper in one
- Crimps open barrel terminals
- 3.2mm thickness

LIFETIME WARRANTY*



KTI56203

Professional Crimping Tool - 0.5/1.5/2.5/4.0/6.0 MM2

- Crimps non-insulated terminals
- Easy to grip handles

LIFETIME WARRANTY*



KTI56205

8.7" Ratcheting Terminal Crimper

- 8.7" Ratchet Crimper for insulated terminal
- Polypropylene and thermoplastic rubber handle
- Tool capacity: Red 22-18 AWG, Blue 16-14 AWG, Yellow 12-10 AWG
- Carbon steel head
- Adjusted by screwdriver
- Ratcheting Terminal Crimper

LIFETIME WARRANTY*



KTI56207

9.75" Professional 8-in-1 Quick and Easy Wire Stripper

- Wire cutter, bolt cutter, wire stripper, and bending wire
- Crimps insulated, non-insulated, and pin terminals

LIFETIME WARRANTY*



Dyna Loom - Split Wire Loom

Part #	Size	Length
KTI02751	1/2" I.D. Split Wire Loom	7'
KTI02761	1/4" I.D. Split Wire Loom	10'
KTI02771	3/4" I.D. Split Wire Loom	5'
KTI02781	3/8" I.D. Split Wire Loom	10'
KTI02791	5/8" I.D. Split Wire Loom	6'



Dyna Loom - Routing Clips

Part #	Description	Qty
KTI02742	1/4" Wire Loom Clips	10
KTI02743	3/8" Wire Loom Clips	10
KTI02744	1/2" Wire Loom Clips	10
KTI02745	5/8" and 3/4" Wire Loom Clips	10



Primary Wire			
Part #	Color	Gauge	Length
KT101912	Red	10 Gauge	8'
KT101920	Black	10 Gauge	8'
KT101939	White	10 Gauge	8'
KT102012	Red	12 Gauge	10'
KT102020	Black	12 Gauge	10'
KT102039	White	12 Gauge	10'
KT102112	Red	14 Gauge	15'
KT102127	Yellow	14 Gauge	15'
KT102130	Black	14 Gauge	15'
KT102149	White	14 Gauge	15'
KT102212	Red	16 Gauge	25'
KT102227	Yellow	16 Gauge	25'
KT102230	Black	16 Gauge	25'
KT102249	White	16 Gauge	25'
KT102312	Red	18 Gauge	30'
KT102327	Yellow	18 Gauge	30'
KT102330	Black	18 Gauge	30'
KT102349	White	18 Gauge	30'



LIFETIME WARRANTY*

KT172765 Mini Heavy-duty Circuit Tester

- Tester is 5" long and includes 2" tempered probe and replaceable bulb
- Works on 6 or 12 volt systems
- Features 60" heavy-duty flexible wire lead with ground clip

Replacement parts:

KT172781 - Replacement bulb for models 72765, 72780, 72790, 72791 and 72792



KT172782 Heavy-duty Circuit Tester with 10' Retractable Wire and Clip

- Can be used on cars, trucks, SUVs, boats, trailers, vans, RVs, motorcycles, snowmobiles and airplanes
- Use the heavy-duty circuit tester to check electrical circuits and accessories on all 6 and 12 volt systems
- Tester features a 10' retractable wire and battery clip, spring-supported strain relief, extra-sharp probe and a heavy-duty battery clip

LIFETIME WARRANTY*



KT172780 Heavy-duty Circuit Tester

- Tester features 5' heavy-duty flexible wire, ground clips, tempered probe and replaceable bulb
- Works on 6 or 12 volt systems. Spring strain relief on cord

LIFETIME WARRANTY*



Replacement parts:

KT172781 - Replacement bulb for models 72765, 72780, 72790, 72791 and 72792



KT172770 Circuit Tester

Tester features 48" extra long leads. Works on 6 or 12 volt systems.

LIFETIME WARRANTY*



Replacement parts:

KT172771 - Replacement bulb for model 72770



Extra-long Circuit Testers

- Specially designed to enable technicians to test hard to reach circuits that would not be accessible with standard testers
- Features extra long, colored, insulated 7-1/2" probe and 60" heavy gauge flexible wire
- Works on 6 or 12 volt systems



Sold separately:

KT172790 - Blue
KT172791 - Yellow
KT172792 - Red
KT172781 - Replacement bulb for models

72765, 72780, 72790, 72791 and 72792

LIFETIME WARRANTY*



PAINT & BODY TOOLS



1.800.762.6002 | www.ktoolinternational.com

PBE | Paint

KT180955 Touch-up Paint Gun

Includes plastic cup. For touch up, edging, shading or precision detail painting.

Warranty: Repair only up to 1 year



KT180995 Deluxe Spray Gun

This deluxe spray gun features a siphon feed, external mix, built-in regulator and dripless cup. Gun works with all types of automotive refinishing materials.

Warranty: Repair only up to 1 year



KT189194 2-pack Spray Gun Filters



KT189195 Filter Regulator & Lubricator, 2 Piece

- Miniature Filter regulator and lubricator 2 piece space saving combination
- 40 micron sintered bronze filter element, polycarbonate bowl with metal bowl guard
- 1/4" NPT, maximum flow 18 CFM (500 LPM)
- Semi automatic night time drain
- Pressure range: 7-145 PSI
- 1-Year Warranty



KT180998 Deluxe Production Spray Gun

Professional quality gun provides superior atomization of high solid base coats, clear coats, acrylic enamels, acrylic lacquers, and metallic and other coatings. Includes dripless cup.

Warranty: Repair only up to 1 year



KT180996 Dripless Spray Gun Cup



Air Regulators

KT189191 1/4 inch Air Regulator



KT189193 1/4 inch Air Regulator with Gauge



KT180989 Paint Spray Gun Cleaning Kit

Contains all necessary brushes and tools to effectively clean spray guns. Safe to use with chemicals and solvents.



PAINT & BODY TOOLS

PBE | Body



LIFETIME WARRANTY*

KT170031

5-Piece Upholstery Clip Remover Set

This set combines the most popular individual upholstery tools into one master set. Includes both "U" and "V" clip styles of tools as well as a reverse U-blade door panel clip removal tool. This is a complete set for anyone working on car upholstery or for removing panels from dash or door. Comes in a thermoformed tray for easy storage in any tool box. Available individually.

Set includes (also available individually):

KT170032 - "V" Blade Door Panel Tool with Stainless Steel Blade

KT170033 - "U" Blade Door Panel Tool with Stainless Steel Blade

KT170034 - "U" Blade Mini Trim Panel Tool with Stainless Steel Blade

KT170035 - "V" Blade Mini Trim Panel Tool with Stainless Steel Blade

KT170036 - Reverse "U" Blade Door Panel Tool with Stainless Steel Blade



LIFETIME WARRANTY*

KT150201

Universal Body Clip Plier

These specially designed, patented pliers will remove almost any clip found on trim, bumpers and other areas of the vehicle. The steel levers are enclosed in PMS plastic to prevent scratches. Specially sized and angled tip make these pliers the most versatile clip removal tool. Body clip pliers remove clips found on almost every vehicle - inside and out! Lifetime warranty.



KT170540

Windshield Removing Tool

Facilitates removal of windshields and backlights by cutting sealant around windows. Each tool includes an extra replacement blade.

R **LIFETIME WARRANTY***

Replacement parts:

KT170541 - Replacement blade

KT170545

Professional Heavy-Duty Windshield Knife



Features professional-grade construction from heavy-duty steel and aluminum. Knife is lightweight and easy-to-use. Extra-long reach to cut hardened urethane all the way down to the dash line and offers increased leverage and greater control for a safer, smoother cut. The padded, ergonomic handle also features storage space for replacement blades. Blades can be easily changed by releasing a simple one-screw retaining clip.

R **LIFETIME WARRANTY***

Replacement parts:

KT170546 - Replacement blades 6-pack



LIFETIME WARRANTY*

KT179100

Heavy-Duty Riveter

Features four different nose pieces to secure rivets: 3/32" (2.4 mm), 1/8" (3.2 mm), 5/32" (4.0 mm) and 3/16" (4.8 mm). Includes rivet samples.



LIFETIME WARRANTY*

KT179110

Super Heavy-Duty Riveter

Tool's 17" handles provide the leverage needed to effortlessly secure five different rivets: 1/8" (3.2 mm), 5/32" (4.0 mm), 3/16" (4.8 mm), 7/32" (6.0 mm) and 1/4" (6.4 mm).



KTI70037
Clip Lifter

- Clip lifter for plastic fasteners, upholstery, door panels, plastic clips
- Tool length: 7"
- Tool width: 3/4"
- Red rubber handle
- Covered by a 1-Year Warranty



KTI70037-10
Clip Lifter



- Clip lifter for plastic fasteners, upholstery, door panels, plastic clips
- Tool length: 7" • Tool width: 3/4"
- Red rubber handle
- Covered by a 1-Year Warranty



KTI70038
Combi Wedge

- Heavy duty universal combination wedge tool
- Use on dashboards and door cover clips
- Color: Red
- Tool length: 8.5", width: 1", height: 1"
- Covered by a 1 year warranty



KTI70038-10
Combi Wedge 10 Pack



- Counter display 10 pack of the heavy duty universal combination wedge tool
- Use on dashboards and door cover clips
- Color: Red
- Tool length: 8.5", width: 1", height: 1"
- Covered by a 1 year warranty
- Counter display measures: Height: 7.0" Width: 11.750", Depth: 7.50"

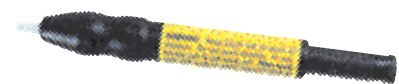

KTI70550
Sanding Pen

Over 20,000 glass fibers in a pen point reach where normal sand paper cannot. Includes one extra sanding point in rear cap.

Replacement parts:

KTI70551 - 2-pack refill for sanding pen





DISPLAYS



1.800.762.6002 | www.ktoolinternational.com

Displays | Wall

KT10805 1/4" Drive Tools & Sockets

Display assortments include the following hardware:

- Hooks, printed overlay, overlay fasteners
- Display boards must be purchased separately (KT1098)



1/4" Drive Tools & Sockets	Qty	
KT121000.....	1/4" DR SOCKET SET.....	1
KT121002.....	1/4" DR 2" EXTENSION.....	1
KT121004.....	1/4" DR 4" EXTENSION.....	1
KT121006.....	1/4" DR 6" EXTENSION.....	1
KT121010.....	1/4" DR EXTENSION 10".....	1
KT121014.....	1/4" DR EXTENSION 14".....	1
KT121043.....	4" WOBBLE EXTENSION 1/4" DR.....	1
KT121044.....	1/4" DR 44PC SOCKET SET.....	1
KT121046.....	6" WOBBLE EXTENSION 1/4" DR.....	1
KT121048.....	9" WOBBLE EXTENSION 1/4" DR.....	1
KT121050.....	1/4" DR UNIVERSAL JOINT.....	1
KT121060.....	1/4" DR SPINNER HANDLE.....	1
KT121080.....	1/4" DR 6" FLEX HANDLE.....	1
KT121091.....	1/4" DR PUSH BUTTON RATCHET.....	1
KT121092.....	1/4" PRO RATCHET.....	1
KT121095.....	LONG HANDLE 1/4" DR RATCHET.....	1
KT121106.....	1/4" DR SHORT SOCKET 3/16".....	1
KT121107.....	1/4" DR SHORT SOCKET 7/32".....	1
KT121108.....	1/4" DR SHORT SOCKET 1/4".....	1
KT121109.....	1/4" DR SHORT SOCKET 9/32".....	1
KT121110.....	1/4" DR SHORT SOCKET 5/16".....	1
KT121111.....	1/4" DR SHORT SOCKET 11/32".....	1
KT121112.....	1/4" DR SHORT SOCKET 3/8".....	1
KT121114.....	1/4" DR SHORT SOCKET 7/16".....	1
KT121116.....	1/4" DR SHORT SOCKET 1/2".....	1
KT121118.....	1/4" DR 6 POINT SHORT SOCKET 9/16".....	1
KT121206.....	1/4" DR DEEP SOCKET 3/16".....	1
KT121207.....	1/4" DR DEEP SOCKET 7/32".....	1
KT121208.....	1/4" DR DEEP SOCKET 1/4".....	1
KT121209.....	1/4" DR DEEP SOCKET 9/32".....	1
KT121210.....	1/4" DR DEEP SOCKET 5/16".....	1
KT121211.....	1/4" DR DEEP SOCKET 11/32".....	1
KT121212.....	1/4" DR DEEP SOCKET 3/8".....	1
KT121214.....	1/4" DR DEEP SOCKET 7/16".....	1
KT121216.....	1/4" DR DEEP SOCKET 1/2".....	1
KT121218.....	1/4" DR 6 POINT DEEP SOCKET 9/16".....	1
KT126000.....	1/4" DR METRIC SOCKET SET.....	1
KT126104.....	1/4" DR SHORT SOCKET 4MM.....	1
KT126105.....	1/4" DR SHORT SOCKET 5MM.....	1
KT126106.....	1/4" DR SHORT SOCKET 6MM.....	1
KT126107.....	1/4" DR SHORT SOCKET 7MM.....	1
KT126108.....	1/4" DR SHORT SOCKET 8MM.....	1
KT126109.....	1/4" DR SHORT SOCKET 9MM.....	1
KT126110.....	1/4" DR SHORT SOCKET 10MM.....	1
KT126111.....	1/4" DR SHORT SOCKET 11MM.....	1
KT126114.....	1/4" DR 6 POINT SHORT SOCKET 14MM.....	1
KT126115.....	1/4" DR 6 POINT SHORT SOCKET 15MM.....	1
KT126155.....	1/4" DR SHORT SOCKET 5.5MM.....	1



KT126206.....	1/4" DR DEEP SOCKET 6MM.....	1
KT126207.....	1/4" DR DEEP SOCKET 7MM.....	1
KT126208.....	1/4" DR DEEP SOCKET 8MM.....	1
KT126209.....	1/4" DR DEEP SOCKET 9MM.....	1
KT126210.....	1/4" DR DEEP SOCKET 10MM.....	1
KT126211.....	1/4" DR DEEP SOCKET 11MM.....	1
KT126212.....	1/4" DR DEEP SOCKET 12MM.....	1
KT126213.....	1/4" DR DEEP SOCKET 13MM.....	1
KT126214.....	1/4" DR 6 POINT SHORT SOCKET 14MM.....	1
KT126215.....	1/4" DR 6 POINT DEEP SOCKET 15MM.....	1
KT126255.....	1/4" DR DEEP SOCKET 5.5MM.....	1
KT1089.....	3" EXTENSION BAR.....	1
KTIH00K11.....	PLASTIC HOOKS.....	12
KTIH00K2.....	HOOKS.....	29
KTIH00K3.....	HOOKS.....	2
KTIOL0805.....	DISPLAY OVERLAY.....	1
KTIOLF04333.....	OVERLAY FASTENERS (6 PACK).....	1



DISPLAYS

KT10806

3/8" Drive Tools

Display assortments include the following hardware:

- Hooks, printed overlay, overlay fasteners
- Display boards must be purchased separately (KT1098)



3/8" Drive Tools	Qty	
KT121055.....	1/4" F X 3/8" M ADAPTER.....	1
KT122000.....	3/8" DR SOCKET SET.....	1
KT122002.....	3/8" DR EXTENSION 2".....	1
KT122003.....	3/8" DR EXTENSION 3".....	1
KT122005.....	3/8" DR EXTENSION 5".....	1
KT122006.....	3/8" DR EXTENSION 6".....	1
KT122008.....	3/8" DR EXTENSION 8".....	1
KT122010.....	3/8" DR EXTENSION 10".....	1
KT122012.....	3/8" DR EXTENSION 12".....	1
KT122018.....	3/8" DR EXTENSION 18".....	1
KT122024.....	3/8" DR EXTENSION 24".....	1
KT122043.....	3/8" DR WOBBLE EXTENSION 3".....	1
KT122046.....	3/8" DR WOBBLE EXTENSION 6".....	1
KT122047.....	3/8" DR 47PC SOCKET SET 6 POINT.....	1
KT122048.....	3/8" DR WOBBLE EXTENSION 8".....	1
KT122050.....	1/2" F X 3/8" M ADAPTER.....	1
KT122055.....	3/8" F X 1/2" M ADAPTER.....	1
KT122060.....	3/8" F X 1/4" M ADAPTER.....	1
KT122071.....	3/8" DR SPEED HANDLE.....	1
KT122080.....	8" FLEX HANDLE.....	1
KT122091.....	3/8" DR PUSH BUTTON RATCHET.....	1
KT122092.....	3/8" PRO RATCHET.....	1
KT122093.....	3/8" DR FLEX HEAD RATCHET.....	1
KT122095.....	LONG HANDLE 3/8" DR RATCHET.....	1
KT122133.....	3/8" DR 2in1 SOCKET 1-1/16" DEEP.....	1
KT122219.....	EXTRA DEEP 5/8" SPARK PLUG SKT.....	1
KT122221.....	3/8" DR SPARKPLUG SKT 6PT 5/8".....	1
KT122227.....	3/8" DR SPARKPLUG SKT 6PT 13/16".....	1
KT122500.....	UNIVERSAL JOINT 3/8" DR.....	1
KT122521.....	5/8" SPARKPLUG SKT 3/8" DR UNIV.....	1
KT122527.....	13/16" SPARKPLUG SKT 3/8" DR UNV.....	1
KT127000.....	3/8" DR METRIC SOCKET SET.....	1
KT1089.....	3" EXTENSION BAR.....	1
KT1HOOK2.....	HOOKS.....	20
KT1HOOK3.....	HOOKS.....	4
KT1HOOK11.....	PLASTIC HOOKS.....	12
KT1OL0806.....	DISPLAY OVERLAY.....	1
KT1OLF04333.....	OVERLAY FASTENERS (6 PACK).....	1





KTI0807
3/8" Drive Sockets

Display assortments include the following hardware:

- Hooks, printed overlay, overlay fasteners
- **Display boards must be purchased separately (KTI098)**



3/8" Drive Sockets.....	Qty
KTI22110..... 3/8" DR SHORT SOCKET 5/16"	1
KTI22112..... 3/8" DR SHORT SOCKET 3/8"	1
KTI22114..... 3/8" DR SHORT SOCKET 7/16"	1
KTI22116..... 3/8" DR SHORT SOCKET 1/2"	1
KTI22118..... 3/8" DR SHORT SOCKET 9/16"	1
KTI22120..... 3/8" DR SHORT SOCKET 5/8"	1
KTI22122..... 3/8" DR SHORT SOCKET 11/16"	1
KTI22124..... 3/8" DR SHORT SOCKET 3/4"	1
KTI22126..... 3/8" DR SHORT SOCKET 13/16"	1
KTI22128..... 3/8" DR SHORT SOCKET 7/8"	1
KTI22130..... 3/8" DR 6 POINT SOCKET 15/16"	1
KTI22132..... 3/8" DR 6 POINT SOCKET 1"	1
KTI22210..... 3/8" DR DEEP SOCKET 5/16"	1
KTI22212..... 3/8" DR DEEP SOCKET 3/8"	1
KTI22214..... 3/8" DR DEEP SOCKET 7/16"	1
KTI22216..... 3/8" DR DEEP SOCKET 1/2"	1
KTI22218..... 3/8" DR DEEP SOCKET 9/16"	1
KTI22220..... 3/8" DR DEEP SOCKET 5/8"	1
KTI22222..... 3/8" DR DEEP SOCKET 11/16"	1
KTI22224..... 3/8" DR DEEP SOCKET 3/4"	1
KTI22226..... 3/8" DR DEEP SOCKET 13/16"	1
KTI22228..... 3/8" DR DEEP SOCKET 7/8"	1
KTI22230..... 3/8" DR 6 POINT SOCKET 15/16"	1
KTI22232..... 3/8" DR 6 POINT DEEP SOCKET 1"	1
KTI22408..... 3/8" DR 12PT DEEP SOCKET 1/4"	1
KTI22410..... 3/8" DR 12PT DEEP SOCKET 5/16"	1
KTI22412..... 3/8" DR 12PT DEEP SOCKET 3/8"	1
KTI22414..... 3/8" DR 12PT DEEP SOCKET 7/16"	1
KTI22416..... 3/8" DR 12PT DEEP SOCKET 1/2"	1
KTI22418..... 3/8" DR 12PT DEEP SOCKET 9/16"	1
KTI22420..... 3/8" DR 12PT DEEP SOCKET 5/8"	1
KTI22422..... 3/8" DR 12PT DEEP SOCKET 11/16"	1
KTI22424..... 3/8" DR 12PT DEEP SOCKET 3/4"	1
KTI22426..... 3/8" DR 12PT DEEP SOCKET 13/16"	1
KTI22428..... 3/8" DR 12PT DEEP SOCKET 7/8"	1
KTI22430..... 3/8" DR 12PT DEEP SOCKET 15/16"	1
KTI22432..... 3/8" DR 12PT DEEP SOCKET 1"	1
KTI22508..... 3/8" DR 12PT SHORT SOCKET 1/4"	1
KTI22510..... 3/8" DR 12PT SHORT SOCKET 5/16"	1
KTI22512..... 3/8" DR 12PT SHORT SOCKET 3/8"	1
KTI22514..... 3/8" DR 12PT SHORT SOCKET 7/16"	1
KTI22516..... 3/8" DR 12PT SHORT SOCKET 1/2"	1
KTI22518..... 3/8" DR 12PT SHORT SOCKET 9/16"	1
KTI22520..... 3/8" DR 12PT SHORT SOCKET 5/8"	1

3/8" Drive Sockets.....	Qty
KTI22522..... 3/8" DR 12PT SHORT SOCKET 11/16"	1
KTI22524..... 3/8" DR 12PT SHORT SOCKET 3/4"	1
KTI22526..... 3/8" DR 12PT SHORT SOCKET 13/16"	1
KTI22528..... 3/8" DR 12PT SHORT SOCKET 7/8"	1
KTI22530..... 3/8" DR 12PT SHORT SOCKET 15/16"	1
KTI22532..... 3/8" DR 12PT SHORT SOCKET 1"	1
KTI27107..... 3/8" DR SHORT SOCKET 7MM.....	1
KTI27108..... 3/8" DR SHORT SOCKET 8MM.....	1
KTI27109..... 3/8" DR SHORT SOCKET 9MM.....	1
KTI27110..... 3/8" DR SHORT SOCKET 10MM.....	1
KTI27111..... 3/8" DR SHORT SOCKET 11MM.....	1
KTI27112..... 3/8" DR SHORT SOCKET 12MM.....	1
KTI27113..... 3/8" DR SHORT SOCKET 13MM.....	1
KTI27114..... 3/8" DR SHORT SOCKET 14MM.....	1
KTI27115..... 3/8" DR SHORT SOCKET 15MM.....	1
KTI27116..... 3/8" DR SHORT SOCKET 16MM.....	1
KTI27117..... 3/8" DR SHORT SOCKET 17MM.....	1
KTI27118..... 3/8" DR SHORT SOCKET 18MM.....	1
KTI27119..... 3/8" DR SHORT SOCKET 19MM.....	1
KTI27120..... 3/8" DR SHORT SOCKET 20MM.....	1
KTI27121..... 3/8" DR SHORT SOCKET 21MM.....	1
KTI27122..... 3/8" DR 6 POINT SHORT SOCKET 22MM.....	1
KTI27123..... 3/8" DR 6 POINT SHORT SOCKET 23MM.....	1
KTI27124..... 3/8" DR 6 POINT SHORT SOCKET 24MM.....	1
KTI27125..... 3/8" DR 6 POINT SHORT SOCKET 25MM.....	1
KTI27126..... 3/8" DR 6 POINT SHORT SOCKET 26MM.....	1
KTI27207..... 3/8" DR DEEP SOCKET 7MM.....	1
KTI27208..... 3/8" DR DEEP SOCKET 8MM.....	1
KTI27209..... 3/8" DR DEEP SOCKET 9MM.....	1
KTI27210..... 3/8" DR DEEP SOCKET 10MM.....	1
KTI27211..... 3/8" DR DEEP SOCKET 11MM.....	1
KTI27212..... 3/8" DR DEEP SOCKET 12MM.....	1
KTI27213..... 3/8" DR DEEP SOCKET 13MM.....	1
KTI27214..... 3/8" DR DEEP SOCKET 14MM.....	1
KTI27215..... 3/8" DR DEEP SOCKET 15MM.....	1
KTI27216..... 3/8" DR DEEP SOCKET 16MM.....	1
KTI27217..... 3/8" DR DEEP SOCKET 17MM.....	1
KTI27218..... 3/8" DR DEEP SOCKET 18MM.....	1
KTI27219..... 3/8" DR DEEP SOCKET 19MM.....	1
KTI27220..... 3/8" DR 6 POINT DEEP SOCKET 20MM.....	1
KTI27221..... 3/8" DR 6 POINT DEEP SOCKET 21MM.....	1
KTI27222..... 3/8" DR 6 POINT DEEP SOCKET 22MM.....	1
KTI27223..... 3/8" DR 6 POINT DEEP SOCKET 23MM.....	1
KTI27224..... 3/8" DR 6 POINT DEEP SOCKET 24MM.....	1
KTI27225..... 3/8" DR 6 POINT DEEP SOCKET 25MM.....	1
KTI27226..... 3/8" DR 6 POINT DEEP SOCKET 26MM.....	1
KTI27407..... 3/8" DR 12PT DEEP SOCKET 7MM.....	1
KTI27408..... 3/8" DR 12PT DEEP SOCKET 8MM.....	1
KTI27409..... 3/8" DR 12PT DEEP SOCKET 9MM.....	1
KTI27410..... 3/8" DR 12PT DEEP SOCKET 10MM.....	1
KTI27411..... 3/8" DR 12PT DEEP SOCKET 11MM.....	1
KTI27412..... 3/8" DR 12PT DEEP SOCKET 12MM.....	1
KTI27413..... 3/8" DR 12PT DEEP SOCKET 13MM.....	1
KTI27414..... 3/8" DR 12PT DEEP SOCKET 14MM.....	1
KTI27415..... 3/8" DR 12PT DEEP SOCKET 15MM.....	1
KTI27416..... 3/8" DR 12PT DEEP SOCKET 16MM.....	1
KTI27417..... 3/8" DR 12PT DEEP SOCKET 17MM.....	1
KTI27418..... 3/8" DR 12PT DEEP SOCKET 18MM.....	1
KTI27419..... 3/8" DR 12PT DEEP SOCKET 19MM.....	1
KTI27420..... 3/8" DR 12PT DEEP SOCKET 20MM.....	1
KTI27421..... 3/8" DR 12PT DEEP SOCKET 21MM.....	1
KTI27507..... 3/8" DR 12PT SHORT SOCKET 7MM.....	1
KTI27508..... 3/8" DR 12PT SHORT SOCKET 8MM.....	1
KTI27509..... 3/8" DR 12PT SHORT SOCKET 9MM.....	1
KTI27510..... 3/8" DR 12PT SHORT SOCKET 10MM.....	1
KTI27511..... 3/8" DR 12PT SHORT SOCKET 11MM.....	1
KTI27512..... 3/8" DR 12PT SHORT SOCKET 12MM.....	1
KTI27513..... 3/8" DR 12PT SHORT SOCKET 13MM.....	1
KTI27514..... 3/8" DR 12PT SHORT SOCKET 14MM.....	1
KTI27515..... 3/8" DR 12PT SHORT SOCKET 15MM.....	1
KTI27516..... 3/8" DR 12PT SHORT SOCKET 16MM.....	1
KTI27517..... 3/8" DR 12PT SHORT SOCKET 17MM.....	1
KTI27518..... 3/8" DR 12PT SHORT SOCKET 18MM.....	1
KTI27519..... 3/8" DR 12PT SHORT SOCKET 19MM.....	1
KTI27520..... 3/8" DR 12PT SHORT SOCKET 20MM.....	1
KTI27521..... 3/8" DR 12PT SHORT SOCKET 21MM.....	1
KTIH00K2..... HOOKS.....	60
KTIOL0807..... DISPLAY OVERLAY.....	1
KTIOLF04333..... OVERLAY FASTENERS (6 PACK).....	1



DISPLAYS

KT10808

1/2" Drive Tools & Sockets

Display assortments include the following hardware:

- Hooks, printed overlay, overlay fasteners
- Display boards must be purchased separately (KT1098)



1/2" Drive Tools & Sockets..... Qty

KT122075.....	CHROME ADAPTER 1/2" F X 3/4" M.....	1
KT123003.....	1/2" DR 3" EXTENSION.....	1
KT123005.....	1/2" DR 5" EXTENSION.....	1
KT123010.....	1/2" DR 10" EXTENSION.....	1
KT123015.....	1/2" DR EXTENSION 15".....	1
KT123020.....	1/2" DR EXTENSION 20".....	1
KT123070.....	1/2" DR SLIDING T-HANDLE.....	1
KT123080.....	1/2" DR 17" BREAKER BAR.....	1
KT123081.....	1/2" DR 24" BREAKER BAR.....	1
KT123082.....	1/2" DR EXTENDING BREAKER BAR.....	1
KT123083.....	1/2" DR 10" FLEX HANDLE.....	1
KT123091.....	1/2" DR PUSH BUTTON RATCHET.....	1
KT123092.....	1/2" PRO RATCHET.....	1
KT123095.....	PRO SERIES 1/2 LONG RATCHET.....	1
KT123112.....	1/2" DR 6 POINT SHORT SOCKET 3/8".....	1
KT123114.....	1/2" DR SHORT SOCKET 7/16".....	1
KT123116.....	1/2" DR SHORT SOCKET 1/2".....	1
KT123118.....	1/2" DR SHORT SOCKET 9/16".....	1
KT123120.....	1/2" DR SHORT SOCKET 5/8".....	1
KT123122.....	1/2" DR SHORT SOCKET 11/16".....	1
KT123124.....	1/2" DR SHORT SOCKET 3/4".....	1
KT123126.....	1/2" DR SHORT SOCKET 13/16".....	1
KT123128.....	1/2" DR SHORT SOCKET 7/8".....	1
KT123130.....	1/2" DR SHORT SOCKET 15/16".....	1
KT123132.....	1/2" DR SHORT SOCKET 1".....	1
KT123134.....	1/2" DR SHORT SOCKET 1-1/16".....	1
KT123136.....	1/2" DR SHORT SOCKET 1-1/8".....	1
KT123140.....	1/2" DR SHORT SOCKET 1-1/4".....	1
KT123142.....	1/2" DR 6 POINT SHORT SOCKET 1-5/16".....	1
KT123144.....	1/2" DR 6 POINT SHORT SOCKET 1-3/8".....	1
KT123146.....	1/2" DR 6 POINT SHORT SOCKET 1-7/16".....	1
KT123148.....	1/2" DR 6 POINT SHORT SOCKET 1-1/2".....	1
KT123214.....	1/2" DR 6 POINT DEEP SOCKET 7/16".....	1
KT123216.....	1/2" DR DEEP 6 PT.SOCKET 1/2".....	1
KT123218.....	1/2" DR DEEP 6 PT.SOCKET 9/16".....	1
KT123220.....	1/2" DR DEEP 6 PT.SOCKET 5/8".....	1
KT123222.....	1/2" DR DEEP 6 PT.SOCKET 11/16".....	1
KT123224.....	1/2" DR DEEP 6 PT.SOCKET 3/4".....	1
KT123226.....	1/2" DR DEEP 6 PT.SOCKET 13/16".....	1
KT123228.....	1/2" DR DEEP 6 PT.SOCKET 7/8".....	1
KT123230.....	1/2" DR DEEP 6 PT.SOCKET 15/16".....	1
KT123232.....	1/2" DR 6 POINT DEEP SOCKET 1".....	1
KT123234.....	1/2" DR 6 POINT DEEP SOCKET 1-1/16".....	1
KT123236.....	1/2" DR 6 POINT DEEP SOCKET 1-1/8".....	1
KT123240.....	1/2" DR 6 POINT DEEP SOCKET 1-1/4".....	1
KT123242.....	1/2" DR 6 POINT DEEP SOCKET 1-5/16".....	1
KT123244.....	1/2" DR 6 POINT DEEP SOCKET 1-3/8".....	1
KT123246.....	1/2" DR 6 POINT DEEP SOCKET 1-7/16".....	1
KT123248.....	1 1/2" HEATING ELEMENT SOCKET.....	1
KT123500.....	1/2" DR. UNIVERSAL.....	1
KT123808.....	1/4" STUD REMOVER 1/2" DR.....	1
KT123810.....	5/16" STUD REMOVER 1/2" DR.....	1
KT123812.....	3/8" STUD REMOVER 1/2" DR.....	1
KT123814.....	7/16" STUD REMOVER 1/2" DR.....	1
KT123906.....	6 MM STUD REMOVER 1/2" DR.....	1
KT123908.....	8 MM STUD REMOVER 1/2" DR.....	1
KT123910.....	10 MM STUD REMOVER 1/2" DR.....	1
KT123912.....	12 MM STUD REMOVER 1/2" DR.....	1
KT124050.....	3/4" F X 1/2" M ADAPTER.....	1
KT128110.....	1/2" DR 6 POINT SHORT SOCKET 10MM.....	1
KT128111.....	1/2" DR 6 POINT SHORT SOCKET 11MM.....	1
KT128112.....	1/2" DR 6 POINT SHORT SOCKET 12MM.....	1
KT128113.....	1/2" DR 6 POINT SHORT SOCKET 13MM.....	1
KT128114.....	1/2" DR 6 POINT SHORT SOCKET 14MM.....	1

1/2" Drive Tools & Sockets..... Qty

KT128115.....	1/2" DR SHORT SOCKET 15MM.....	1
KT128116.....	1/2" DR SHORT SOCKET 16MM.....	1
KT128117.....	1/2" DR SHORT SOCKET 17MM.....	1
KT128118.....	1/2" DR SHORT SOCKET 18MM.....	1
KT128119.....	1/2" DR SHORT SOCKET 19MM.....	1
KT128120.....	1/2" DR SHORT SOCKET 20MM.....	1
KT128121.....	1/2" DR SHORT SOCKET 21MM.....	1
KT128122.....	1/2" DR SHORT SOCKET 22MM.....	1
KT128123.....	1/2" DR SHORT SOCKET 23MM.....	1
KT128124.....	1/2" DR SHORT SOCKET 24MM.....	1
KT128125.....	1/2" DR SHORT SOCKET 25MM.....	1
KT128126.....	1/2" DR SHORT SOCKET 26MM.....	1
KT128127.....	1/2" DR SHORT SOCKET 27MM.....	1
KT128128.....	1/2" DR SHORT SOCKET 28MM.....	1
KT128210.....	1/2" DR 6 POINT DEEP SOCKET 10MM.....	1
KT128211.....	1/2" DR 6 POINT DEEP SOCKET 11MM.....	1
KT128212.....	1/2" DR 6 POINT DEEP SOCKET 12MM.....	1
KT128213.....	1/2" DR 6 POINT DEEP SOCKET 13MM.....	1
KT128214.....	1/2" DR 6 POINT DEEP SOCKET 14MM.....	1
KT128215.....	1/2" DR DEEP SOCKET 15MM.....	1
KT128216.....	1/2" DR DEEP SOCKET 16MM.....	1
KT128217.....	1/2" DR DEEP SOCKET 17MM.....	1
KT128218.....	1/2" DR DEEP SOCKET 18MM.....	1
KT128219.....	1/2" DR DEEP SOCKET 19MM.....	1
KT128220.....	1/2" DR DEEP SOCKET 20MM.....	1
KT128221.....	1/2" DR DEEP SOCKET 21MM.....	1
KT128222.....	1/2" DR DEEP SOCKET 22MM.....	1
KT128223.....	1/2" DR DEEP SOCKET 23MM.....	1
KT128224.....	1/2" DR DEEP SOCKET 24MM.....	1
KT128225.....	1/2" DR 6 POINT DEEP SOCKET 25MM.....	1
KT128226.....	1/2" DR 6 POINT DEEP SOCKET 26MM.....	1
KT128227.....	1/2" DR 6 POINT DEEP SOCKET 27MM.....	1
KT128228.....	1/2" DR 6 POINT DEEP SOCKET 28MM.....	1
KT1089.....	3" EXTENSION BAR.....	3
KTIHOOK2.....	HOOKS.....	23
KTIHOOK11.....	PLASTIC HOOKS.....	34
KTIOL0808.....	DISPLAY OVERLAY.....	1
KTIOLF04333.....	OVERLAY FASTENERS (6 PACK).....	1

KTI0809

Screwdrivers #1

Display assortments include the following hardware:

- Hooks, printed overlay, overlay fasteners
- Display boards must be purchased separately (KTI098)



Screwdrivers #1	Qty
KTI11310..... T-10 TORQ SCREWDRIVER.....	2
KTI11315..... T-15 TORQ SCREWDRIVER.....	2
KTI11320..... T-20 TORQ SCREWDRIVER.....	2
KTI16001..... 5 PC SLOTTED SCREWDRIVER SET.....	1
KTI16002..... 5 PC PHILLIPS SCREWDRIVER SET.....	1
KTI16113..... #1 PHILLIPS SCREWDRIVER.....	2
KTI16121..... #2 STUBBY PHILLIPS SCREWDRIVER.....	2
KTI16124..... #2 PHILLIPS SCREWDRIVER.....	2
KTI16129..... #2 LONG PHILLIPS SCREWDRIVER.....	1
KTI16136..... #3 PHILLIPS SCREWDRIVER.....	2
KTI16201..... STUBBY SLOTTED SCREWDRIVER.....	2
KTI16203..... 3" STANDARD SCREWDRIVER.....	2
KTI16204..... 4" STANDARD SCREWDRIVER.....	2
KTI16206..... 6" STANDARD SCREWDRIVER.....	2
KTI16208..... 8" STANDARD SCREWDRIVER.....	2
KTI19000..... 8 PC SCREWDRIVER SET BLACK.....	1
KTI19113..... #1 PHILLIPS SCREWDRIVER BLACK.....	2
KTI19121..... #2 PHILLIPS SCREWDRIVER STUBBY.....	2
KTI19124..... #2 PHILLIPS SCREWDRIVER BLACK.....	2
KTI19201..... STUBBY SCREWDRIVER BLACK.....	2
KTI19203..... 3" STANDARD SCREWDRIVER BLACK.....	2
KTI19204..... 4" STANDARD SCREWDRIVER BLACK.....	2
KTI19206..... 6" STANDARD SCREWDRIVER BLACK.....	2
KTI19208..... 8" STANDARD SCREWDRIVER BLACK.....	2
KTIHOOK2..... HOOKS.....	21
KTIHOOK8..... HOOKS.....	3
KTIOL0809..... DISPLAY OVERLAY.....	1
KTIOLF04333..... OVERLAY FASTENERS (6 PACK).....	1



KTI0850

Screwdrivers #2

Display assortments include the following hardware:

- Hooks, printed overlay, overlay fasteners
- Display boards must be purchased separately (KTI098)



Screwdrivers #2	Qty
KTI18000..... BITS SET 12 Piece.....	2
KTI11001..... SCREWDRIVER SQUARE S1" x 4".....	2
KTI11002..... SCREWDRIVER SQUARE S2" x 4".....	2
KTI11003..... SCREWDRIVER SLOTTED 1/8" x 3".....	2
KTI11005..... SCREWDRIVER SLOTTED 5/32" x 4".....	2
KTI11006..... SCREWDRIVER SLOTTED 3/16" x 6".....	2
KTI11008..... SCREWDRIVER SET 8 Piece.....	2
KTI11009..... SCREWDRIVER SLOTTED 5/16" x 6".....	2
KTI11010..... SCREWDRIVER SLOTTED 1/4" x 1-1/2".....	2
KTI11011..... SCREWDRIVER SLOTTED 1/4" x 4".....	2
KTI11012..... SCREWDRIVER SLOTTED 3/16" x 3".....	2
KTI11211..... SCREWDRIVER TORX T10 x 4".....	2
KTI11215..... SCREWDRIVER TORX T15 x 4".....	2
KTI11220..... SCREWDRIVER TORX T20 X 4".....	2
KTI11221..... SCREWDRIVER PHILLIPS #2 x 1-1/2".....	2
KTI11223..... SCREWDRIVER PHILLIPS #1 x 3".....	2
KTI11224..... SCREWDRIVER PHILLIPS #2 x 4".....	2
KTI11225..... SCREWDRIVER TORX T25 x 4".....	2
KTI11226..... SCREWDRIVER PHILLIPS #3 x 6".....	2
KTI11229..... SCREWDRIVER PHILLIPS #0 x 3".....	2
KTI11230..... SCREWDRIVER PHILLIPS #1 x 6".....	2
KTI18009..... BITS DRIVER.....	2
KTIHOOK2..... HOOKS.....	22
KTIHOOK8..... HOOKS.....	1
KTIOL0850..... DISPLAY OVERLAY.....	1
KTIOLF04333..... OVERLAY FASTENERS (6 PACK).....	1



DISPLAYS

KTI0810

Torq & Hex Sockets

Display assortments include the following hardware:

- Hooks, printed overlay, overlay fasteners
- Display boards must be purchased separately (KTI098)



Torq & Hex Sockets.....	Qty
KTI21810.....	2
KTI21815.....	2
KTI21820.....	2
KTI21825.....	2
KTI21827.....	2
KTI21830.....	2
KTI22800.....	1
KTI22801.....	1
KTI22840.....	2
KTI22845.....	2
KTI22847.....	2
KTI22850.....	2
KTI22855.....	2
KTI22860.....	2
KTI22870.....	1
KTI22874.....	1
KTI22875.....	1
KTI22876.....	1
KTI22877.....	1
KTI22878.....	1
KTI22880.....	1
KTI22882.....	1
KTI22884.....	1
KTI22886.....	1
KTI22888.....	1
KTI22904.....	1
KTI22905.....	1
KTI22906.....	1
KTI22907.....	1
KTI22908.....	1
KTI22910.....	1
KTI22912.....	1
KTI22970.....	1
KTI27903.....	1
KTI27904.....	1
KTI27905.....	1
KTI27906.....	1
KTI27907.....	1
KTI27908.....	1
KTI27910.....	1
KTI27955.....	1
KTI27970.....	1
KTIH00K2.....	42
KTIOL0810.....	1
KTIOLF04333.....	1



KTI0811

Torq & Hex Sockets

Display assortments include the following hardware:

- Hooks, printed overlay, overlay fasteners
- Display boards must be purchased separately (KTI098)



Torq & Hex Sockets.....	Qty
KTI21500.....	1
KTI21610.....	1
KTI21615.....	1
KTI21620.....	1
KTI21625.....	1
KTI21627.....	1
KTI21630.....	1
KTI22601.....	1
KTI22640.....	1
KTI22645.....	1
KTI22647.....	1
KTI22650.....	1
KTI22655.....	1
KTI22660.....	1
KTI22670.....	1
KTI22671.....	1
KTI22675.....	1
KTI22676.....	1
KTI22677.....	1
KTI22678.....	1
KTI22680.....	1
KTI22682.....	1
KTI22684.....	1
KTI22686.....	1
KTI22688.....	1
KTI22689.....	1
KTI22904.....	1
KTI22905.....	1
KTI22906.....	1
KTI22907.....	1
KTI22908.....	1
KTI22910.....	1
KTI22912.....	1
KTI22912.....	1
KTI22970.....	1
KTI27903.....	1
KTI27904.....	1
KTI27905.....	1
KTI27906.....	1
KTI27907.....	1
KTI27908.....	1
KTI27910.....	1
KTI27955.....	1
KTI27970.....	1
KTIH00K2.....	43
KTIOL0811.....	1
KTIOLF04333.....	1



KTI0812

Wrenches

Display assortments include the following hardware:

- Hooks, printed overlay, overlay fasteners
- **Display boards must be purchased separately (KTI098)**



Wrenches	Qty
KTI41110..... COMBINATION WRENCH 5/16".....	1
KTI41112..... COMBINATION WRENCH 3/8".....	2
KTI41114..... COMBINATION WRENCH 7/16".....	2
KTI41116..... COMBINATION WRENCH 1/2".....	3
KTI41118..... COMBINATION WRENCH 9/16".....	3
KTI41120..... COMBINATION WRENCH 5/8".....	2
KTI41122..... COMBINATION WRENCH 11/16".....	2
KTI41124..... COMBINATION WRENCH 3/4".....	2
KTI41126..... COMBINATION WRENCH 13/16".....	1
KTI41128..... COMBINATION WRENCH 7/8".....	1
KTI41130..... COMBINATION WRENCH 15/16".....	1
KTI41132..... COMBINATION WRENCH 1".....	1
KTI41134..... COMBINATION WRENCH 1-1/16".....	1
KTI41136..... COMBINATION WRENCH 1-1/8".....	1
KTI41140..... COMBINATION WRENCH 1-1/4".....	1
KTI41142..... JUMBO COMBO WRENCH 1-5/16".....	1
KTI41212..... 3/8" SHORT COMBINATON WRENCH.....	1
KTI41214..... 7/16" SHORT COMBINATION WRENCH.....	1
KTI41216..... 1/2" SHORT COMBINATION WRENCH.....	1
KTI41218..... 9/16" SHORT COMBINATION WRENCH.....	1
KTI41220..... 5/8" SHORT COMBINATION WRENCH.....	1
KTI41222..... 11/16" SHORT COMBINATION WRENCH.....	1
KTI41224..... 3/4" SHORT COMBINATION WRENCH.....	1
KTI41308..... 1/4" HIGH POLISH COMB. WRENCH.....	1
KTI41310..... 5/16" HIGH POLISH COMB. WRENCH.....	1
KTI41311..... 11/32" HIGH POLISH COMB. WRENCH.....	1
KTI41312..... 3/8" HIGH POLISH COMB. WRENCH.....	2
KTI41314..... 7/16" HIGH POLISH COMB. WRENCH.....	2
KTI41316..... 1/2" HIGH POLISH COMB. WRENCH.....	2
KTI41318..... 9/16" HIGH POLISH COMB. WRENCH.....	2
KTI41320..... 5/8" HIGH POLISH COMB. WRENCH.....	1
KTI41322..... 11/16" HIGH POLISH COMB. WRENCH.....	1
KTI41324..... 3/4" HIGH POLISH COMB. WRENCH.....	1
KTI41326..... 13/16" HIGH POLISH COMB. WRENCH.....	1
KTI41328..... 7/8" HIGH POLISH COMB. WRENCH.....	1
KTI41330..... 15/16" HIGH POLISH COMB. WRENCH.....	1
KTI41332..... 1" HIGH POLISH COMB. WRENCH.....	1
KTI41334..... 1-1/16" HIGH POLISH COMB. WRENCH.....	1
KTI41336..... 1-1/8" HIGH POLISH COMB. WRENCH.....	1
KTI41340..... 1-1/4" HIGH POLISH COMB. WRENCH.....	1
KTI41342..... 1-5/16" HIGH POLISH COMB. WRENCH.....	1
KTI41344..... 1-3/8" HIGH POLISH COMB. WRENCH.....	1
KTI41346..... 1-7/16" HIGH POLISH COMB. WRENCH.....	1
KTI41348..... 1-1/2" HIGH POLISH COMB. WRENCH.....	1
KTI41412..... 6PT COMBINATION WRENCH 3/8".....	1
KTI41414..... 6PT COMBINATION WRENCH 7/16".....	1
KTI41416..... 6PT COMBINATION WRENCH 1/2".....	1
KTI41418..... 6PT COMBINATION WRENCH 9/16".....	1
KTI41420..... 6PT COMBINATION WRENCH 5/8".....	1
KTI41422..... 6PT COMBINATION WRENCH 11/16".....	1
KTI41424..... 6PT COMBINATION WRENCH 3/4".....	1
KTI44412..... 3/8" x 7/16" FLARE NUT WRENCH.....	1
KTI44416..... 1/2" x 9/16" FLARE NUT WRENCH.....	1
KTI44420..... 5/8" x 11/16" FLARE NUT WRENCH.....	1
KTI089..... 3" EXTENSION BAR.....	1
KTIHOOK2..... HOOKS.....	41
KTIHOOK11..... PLASTIC HOOKS.....	16
KTIOL0812..... DISPLAY OVERLAY.....	1
KTIOLF04333..... OVERLAY FASTENERS (6 PACK).....	1

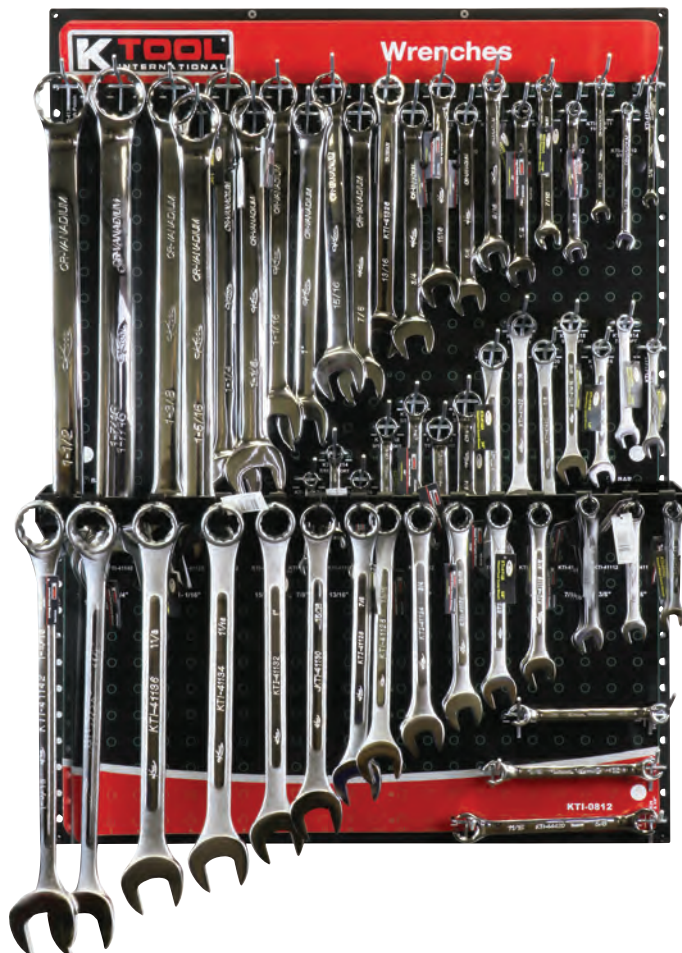

DISPLAYS

KTIO813

Metric Wrenches

Display assortments include the following hardware:

- Hooks, printed overlay, overlay fasteners
- Display boards must be purchased separately (KTIO98)



Metric Wrenches	Qty	
KT141607.....	METRIC COMB WRENCH 7MM	1
KT141608.....	METRIC COMB WRENCH 8MM	1
KT141609.....	METRIC COMB WRENCH 9MM	1
KT141610.....	METRIC COMB WRENCH 10MM	2
KT141611.....	METRIC COMB WRENCH 11MM	2
KT141612.....	METRIC COMB WRENCH 12MM	2
KT141613.....	METRIC COMB WRENCH 13MM	2
KT141614.....	METRIC COMB WRENCH 14MM	2
KT141615.....	METRIC COMB WRENCH 15MM	2
KT141616.....	METRIC COMB WRENCH 16MM	1
KT141617.....	METRIC COMB WRENCH 17MM	1
KT141618.....	METRIC COMB WRENCH 18MM	1
KT141619.....	METRIC COMB WRENCH 19MM	1
KT141708.....	8MM SHORT COMBINATION WRENCH	1
KT141710.....	10MM SHORT COMBINATION WRENCH	1
KT141712.....	12MM SHORT COMBINATION WRENCH	1
KT141713.....	13MM SHORT COMBINATION WRENCH	1
KT141714.....	14MM SHORT COMBINATION WRENCH	1
KT141715.....	15MM SHORT COMBINATION WRENCH	1
KT141717.....	17MM SHORT COMBINATION WRENCH	1
KT141718.....	18MM SHORT COMBINATION WRENCH	1
KT141807.....	7MM HIGH POLISH COMB. WRENCH	1
KT141808.....	8MM HIGH POLISH COMB. WRENCH	1
KT141809.....	9MM HIGH POLISH COMB. WRENCH	1
KT141810.....	10MM HIGH POLISH COMB. WRENCH	2
KT141811.....	11MM HIGH POLISH COMB. WRENCH	1
KT141812.....	12MM HIGH POLISH COMB. WRENCH	2
KT141813.....	13MM HIGH POLISH COMB. WRENCH	2
KT141814.....	14MM HIGH POLISH COMB. WRENCH	1
KT141815.....	15MM HIGH POLISH COMB. WRENCH	2
KT141816.....	16MM HIGH POLISH COMB. WRENCH	1
KT141817.....	17MM HIGH POLISH COMB. WRENCH	1
KT141818.....	18MM HIGH POLISH COMB. WRENCH	2
KT141819.....	19MM HIGH POLISH COMB. WRENCH	1
KT141820.....	METRIC COMB WRENCH 20MM (BULK)	1
KT141821.....	METRIC COMB WRENCH 21MM (BULK)	1
KT141822.....	METRIC COMB WRENCH 22MM (BULK)	1
KT141823.....	METRIC COMB WRENCH 23MM (BULK)	1
KT141824.....	METRIC COMB WRENCH 24MM (BULK)	1
KT141825.....	METRIC COMB WRENCH 25MM (BULK)	1
KT141826.....	METRIC COMB WRENCH 26MM (BULK)	1
KT141827.....	METRIC COMB WRENCH 27MM (BULK)	1
KT141828.....	METRIC COMB WRENCH 28MM (BULK)	1
KT141829.....	METRIC COMB WRENCH 29MM (BULK)	1
KT141830.....	METRIC COMB WRENCH 30MM (BULK)	1
KT141831.....	METRIC COMB WRENCH 31MM (BULK)	1
KT141832.....	METRIC COMB WRENCH 32MM (BULK)	1
KT141833.....	METRIC COMB WRENCH 33MM (BULK)	1
KT141834.....	METRIC COMB WRENCH 34MM (BULK)	1
KT141835.....	METRIC COMB WRENCH 35MM (BULK)	1
KT141836.....	METRIC COMB WRENCH 36MM (BULK)	1
KT144910.....	FLARE NUT WRENCH 10MM x 12MM	1
KT144913.....	FLARE NUT WRENCH 13MM x 14MM	1
KT144917.....	FLARE NUT WRENCH 15MM x 17MM	1
KTIO89.....	3" EXTENSION BAR	1
KTIHOOK11.....	PLASTIC HOOKS	17
KTIHOOK2.....	HOOKS	40
KTIOL0813.....	DISPLAY OVERLAY	1
KTIOLF04333.....	OVERLAY FASTENERS (6 PACK)	1

KTI0814

Jumbo Wrenches

Display assortments include the following hardware:

- Hooks, printed overlay, overlay fasteners
- **Display boards must be purchased separately (KTI098)**



Jumbo Wrenches.....		Qty
KTI41144.....	JUMBO COMBO WRENCH 1-3/8".....	1
KTI41146.....	JUMBO COMBO WRENCH 1-7/16".....	1
KTI41148.....	JUMBO COMBO WRENCH 1-1/2".....	1
KTI41152.....	JUMBO COMBO WRENCH 1-5/8".....	1
KTI41156.....	JUMBO COMBO WRENCH 1-3/4".....	1
KTI41160.....	JUMBO COMBO WRENCH 1-7/8".....	1
KTI41164.....	JUMBO COMBO WRENCH 2".....	1
KTI41168.....	JUMBO COMBO WRENCH 2-1/8" (BULK).....	1
KTI41172.....	JUMBO COMBO WRENCH 2-1/4" (BULK).....	1
KTI41176.....	JUMBO COMBO WRENCH 2-3/8" (BULK).....	1
KTI41180.....	JUMBO COMBO WRENCH 2-1/2" (BULK).....	1
KTI089.....	3" EXTENSION BAR.....	1
KTIHOOK11.....	PLASTIC HOOKS.....	5
KTIHOOK2.....	HOOKS.....	6
KTIOL0814.....	DISPLAY OVERLAY.....	1
KTIOLF04333.....	OVERLAY FASTENERS (6 PACK).....	1

KTI0815

Nylon Ties

Display assortments include the following hardware:

- Hooks, printed overlay, overlay fasteners
- **Display boards must be purchased separately (KTI098)**



Nylon Ties.....		Qty
KTI76000.....	NYLON TIE TOOL.....	1
KTI76040.....	4" CABLE TIE NATURAL 100 PACK.....	2
KTI76070.....	7" CABLE TIE NATURAL 100 PACK.....	2
KTI76110.....	11" CABLE TIE NATURAL 100 PACK.....	2
KTI76140.....	14" CABLE TIE NATURAL 100 PACK.....	2
KTI76145.....	14" HD CABLE TIE NATUR.100 PACK.....	1
KTI77070.....	7" NATURAL MT.HEAD 100 PACK.....	1
KTI77140.....	14" NATURAL MT.HEAD 100 PACK.....	1
KTI78040.....	4" CABLE TIE BLACK 100 PACK.....	2
KTI78070.....	7" CABLE TIE BLACK 100 PACK.....	2
KTI78110.....	11" CABLE TIE BLACK 100 PACK.....	2
KTI78140.....	14" CABLE TIE BLACK 100 PACK.....	2
KTI78145.....	14" HD CABLE TIE BLACK 100 PACK.....	1
KTIHOOK2.....	HOOKS.....	8
KTIOL0815.....	DISPLAY OVERLAY.....	1
KTIOLF04333.....	OVERLAY FASTENERS (6 PACK).....	1

DISPLAYS

KTI0816

Pliers

Display assortments include the following hardware:

- Hooks, printed overlay, overlay fasteners
- Display boards must be purchased separately (KTI098)



Pliers.....	Qty
KTI51006..... 6" NEEDLE NOSE CHROME VANADIUM.....	1
KTI51007..... 7" NEEDLE NOSE CHROME VANADIUM.....	1
KTI51008..... 8" NEEDLE NOSE CHROME VANADIUM.....	1
KTI51111..... 11" NEEDLE NOSE PLIER 90 DEG.....	1
KTI51211..... 11" NEEDLE NOSE PLIER 45 DEG.....	1
KTI51311..... 11" NEEDLE NOSE PLIER "S".....	1
KTI52006..... 6" DIAGONALS CHROME VANADIUM.....	1
KTI52007..... 7" DIAGONALS CHROME VANADIUM.....	1
KTI52107..... 7" H.D. DIAGONALS CHROME VAN.....	1
KTI53004..... 4" CHROME PLIERS RED HANDLES.....	1
KTI53006..... 6" CHROME PLIERS RED HANDLES.....	1
KTI53008..... 8" CHROME PLIERS RED HANDLES.....	1
KTI54006..... 6" GROOVE JOINT PLIER.....	1
KTI54010..... 10" GROOVE JOINT PLIER.....	1
KTI54012..... 12" GROOVE JOINT PLIER.....	1
KTIHOOK2..... HOOKS.....	15
KTIOL0816..... DISPLAY OVERLAY.....	1
KTIOLF04333..... OVERLAY FASTENERS (6 PACK).....	1

KTI0817

Adjustable Wrenches & Locking Pliers/Clamps

Display assortments include the following hardware:

- Hooks, printed overlay, overlay fasteners
- Display boards must be purchased separately (KTI098)



Adjustable Wrenches & Locking Pliers/Clamps.....	Qty
KTI48004..... 4" ADJUSTABLE WRENCH.....	1
KTI48006..... 6" ADJUSTABLE WRENCH.....	1
KTI48008..... 8" ADJUSTABLE WRENCH.....	1
KTI48010..... 10" ADJUSTABLE WRENCH.....	1
KTI48012..... 12" ADJUSTABLE WRENCH.....	1
KTI48015..... 15" ADJUSTABLE WRENCH.....	1
KTI48018..... 18" ADJUSTABLE WRENCH.....	1
KTI58705..... 5" Locking Plier Curved Jaws.....	1
KTI58707..... 7" Locking Plier Curved Jaws.....	1
KTI58710..... 10" Locking Plier Curved Jaws.....	1
KTI58717..... 7" Locking Plier Straight Jaws.....	1
KTI58809..... 9" Welding Locking Clamp.....	1
KTI58811..... 11" Locking C-Clamp Plier.....	1
KTIHOOK2..... HOOKS.....	20
KTIHOOK8..... HOOKS.....	1
KTIOL0817..... DISPLAY OVERLAY.....	1
KTIOLF04333..... OVERLAY FASTENERS (6 PACK).....	1

KTI0819

Files & Scrapers

Display assortments include the following hardware:

- Hooks, printed overlay, overlay fasteners
- **Display boards must be purchased separately (KTI098)**



Files & Scrapers.....	Qty
KTI70020..... LONG HANDLED SCRAPER	1
KTI70023..... 4 PC SCRAPER SET - USA	1
KTI70024..... 3/4" CHISEL EDGE STIFF SCRAPER	1
KTI70025..... 1-1/2" FLEXIBLE SCRAPER	1
KTI70026..... 1-1/2" CHISEL EDGE STIFF SCRAPER.....	1
KTI70028..... 1-1/2" CHISEL SCRAPER.....	1
KTI70029..... 3" FLEX SCRAPER.....	1
KTI72505..... FILE SET 5 PIECE	1
KTI72512..... 6" MILL FILE.....	1
KTI72514..... 10" MILL FILE.....	1
KTI72523..... 8" BASTARD FILE.....	1
KTI72543..... 8" HALF ROUND FILE	1
KTI72553..... 8" ROUND FILE	1
KTIHOOK2..... HOOKS.....	14
KTIOL0819..... DISPLAY OVERLAY	1
KTIOLF04333..... OVERLAY FASTENERS (6 PACK).....	1

KTI0820

Hammers

Display assortments include the following hardware:

- Hooks, printed overlay, overlay fasteners
- **Display boards must be purchased separately (KTI098)**



Hammers.....	Qty
KTI71700..... 3/8" DR IMPACT DRIVER W/4 BITS.....	1
KTI71704..... 4 OZ. BALL PEIN HAMMER	1
KTI71708..... 8 OZ. BALL PEIN HAMMER	1
KTI71714..... 16 OZ. BRASS HAMMER,HICKORY.....	1
KTI71715..... 24 OZ. BRASS HAMMER,HICKORY	1
KTI71716..... 16 OZ. BALL PEIN HAMMER	1
KTI71724..... 4 LB. CROSS-PEIN HAMMER.....	1
KTI71725..... 24 OZ. BALL PEIN HAMMER.....	1
KTI71732..... 32 OZ. BALL PEIN HAMMER	1
KTI71733..... 32 OZ. BRASS HAMMER,HICKORY	1
KTI71751..... 24 OZ. RUBBER Mallet	1
KTIHOOK2..... HOOKS.....	21
KTIOL0820..... DISPLAY OVERLAY	1
KTIOLF04333..... OVERLAY FASTENERS (6 PACK).....	1

DISPLAYS

KTI0821 Snap Ring Pliers

Display assortments include the following hardware:

- Hooks, printed overlay, overlay fasteners
- Display boards must be purchased separately (KTI098)



Snap Ring Pliers	Qty
KTI55112..... 12 pc. Kit Universal Snap Ring	1
KTI55120..... Fixed .038 Tip Convertible Pliers S	1
KTI55121..... Fixed .047 Tip Convertible Pliers S	1
KTI55122..... Fixed .070 Tip Convertible Pliers S	1
KTI55123..... Fixed .090 Tip Convertible Pliers S	1
KTI55130..... Fixed .038 Tip Convertible Pliers 4	1
KTI55131..... Fixed .047 Tip Convertible Pliers 4	1
KTI55132..... Fixed .070 Tip Convertible Pliers 4	1
KTI55133..... Fixed .090 Tip Convertible Pliers 4	1
KTI55140..... Fixed .038 Tip Convertible Pliers 9	1
KTI55141..... Fixed .047 Tip Convertible Pliers 9	1
KTI55142..... Fixed .070 Tip Convertible Pliers 9	1
KTI55143..... Fixed .090 Tip Convertible Pliers 9	1
KTIHOOK2..... HOOKS	14
KTIOL0821..... DISPLAY OVERLAY	1
KTIOLF04333..... OVERLAY FASTENERS (6 PACK)	1



KTI0822

Tie Downs & Tow Straps

Display assortments include the following hardware:

- Hooks, printed overlay, overlay fasteners
- Display boards must be purchased separately (KTI098)



Tie Downs & Tow Straps..... Qty

KTI73801.....	1-7/8" X 10' TOW STRAP 7000LBS.....	1
KTI73802.....	1-3/4" X 15' TOW STRAP 10,000LB.....	1
KTI73803.....	1-3/4" X 25' TOW STRAP 10,000LB.....	1
KTI73861.....	1" X 13' RATCHET TIE DOWN,HOOK.....	1
KTI73862.....	1" X 13' RATCHET TIE DOWN,LOOP.....	1
KTI73864.....	1" X 6' MOTORCYCLE TIE DOWN.....	1
KTI73870.....	4 PACK 1" X 10' RATCH.TIE DOWN.....	1
KTI73871.....	1" X 10' UNIVERSAL TIE DOWN.....	1
KTI73873.....	2 PACK 1" X 13'BUCKLE TIE DOWN.....	1
KTIHOOK2.....	HOOKS.....	12
KTIOL0822.....	DISPLAY OVERLAY.....	1
KTIOLF04333.....	OVERLAY FASTENERS (6 PACK).....	1

KTI0831

Punches & Chisels

Display assortments include the following hardware:

- Hooks, printed overlay, overlay fasteners
- Display boards must be purchased separately (KTI098)



Punches & Chisels..... Qty

KTI70002.....	AUTOMATIC CENTER PUNCH.....	2
KTI72900.....	6 PC PIN PUNCH SET.....	1
KTI72901.....	15PC PUNCH & CHISEL SET.....	1
KTI72911.....	3/32" PIN PUNCH.....	1
KTI72912.....	1/8" PIN PUNCH.....	1
KTI72913.....	5/32" PIN PUNCH.....	1
KTI72914.....	3/16" PIN PUNCH.....	1
KTI72915.....	1/4" PIN PUNCH.....	1
KTI72916.....	5/16" PIN PUNCH.....	1
KTI72921.....	3/32" TAPER PUNCH.....	1
KTI72922.....	1/8" TAPER PUNCH.....	1
KTI72923.....	5/32" TAPER PUNCH.....	1
KTI72924.....	3/16" TAPER PUNCH.....	1
KTI72925.....	1/4" TAPER PUNCH.....	1
KTI72931.....	1/8" CENTER PUNCH.....	1
KTI72932.....	3/16" CENTER PUNCH.....	1
KTI72982.....	3/8" BRASS PUNCH.....	1
KTI72984.....	1/2" BRASS PUNCH.....	1
KTI72986.....	5/8" BRASS PUNCH.....	1
KTI72988.....	3/4" BRASS PUNCH.....	1
KTI73000.....	5 PC CHISEL SET.....	1
KTI73012.....	3/8" COLD CHISEL.....	1
KTI73016.....	1/2" COLD CHISEL.....	1
KTI73020.....	5/8" COLD CHISEL.....	1
KTI73024.....	3/4" COLD CHISEL.....	1
KTI73028.....	7/8" COLD CHISEL.....	1
KTIHOOK2.....	HOOKS.....	29
KTIOL0831.....	DISPLAY OVERLAY.....	1
KTIOLF04333.....	OVERLAY FASTENERS (6 PACK).....	1



DISPLAYS

KT10832

Pneumatic Bits

Display assortments include the following hardware:

- Hooks, printed overlay, overlay fasteners
- Display boards must be purchased separately (KT1098)



KT10833

Pullers

Display assortments include the following hardware:

- Hooks, printed overlay, overlay fasteners
- Display boards must be purchased separately (KT1098)



Pneumatic Bits.....	Qty
KT181900..... 4 PC. PNEUMATIC BIT SET	1
KT181956..... DOUBLE CUT BODY RIPPER.....	1
KT181958..... SLOTTED PANEL CUTTER.....	2
KT181959..... SHEET METAL TRIMMER.....	2
KT181968..... TAIL PIPE CUT OFF.....	1
KT181972..... 6" COLD CHISEL.....	2
KT181973..... 8" COLD CHISEL.....	1
KT181974..... 10" COLD CHISEL.....	1
KT181975..... RIVET & BOLT CUTTER.....	2
KT181976..... SCRAPER.....	1
KT181977..... TAPER PUNCH SHARP POINT.....	1
KT181979..... 3/8" TAPER PUNCH.....	2
KT181982..... HAMMER.....	1
KT181986..... 18" COLD CHISEL.....	1
KT181995..... TIE ROD SEPARATOR-PNEUMATIC.....	1
KT181996..... BALL JOINT SEPARATOR-PNEUMATIC.....	1
KT181997..... 1/8" TAPER PUNCH.....	2
KT183091..... SPRING RETAINER FOR AIR TOOLS.....	2
KT183092..... SAFETY CHUCK.....	1
KT183093..... QUICK COUPLER RETAINER.....	1
KTIHOOK2..... HOOKS.....	22
KTIOL0832..... DISPLAY OVERLAY.....	1
KTIOLF04333..... OVERLAY FASTENERS (6 PACK).....	1

Pullers.....	Qty
KT170311..... 4" TWO JAW ADJUSTABLE PULLER.....	1
KT170312..... 6" TWO JAW REVERSIBLE PULLER.....	1
KT170313..... 7" TWO JAW ADJUSTABLE PULLER.....	1
KT170321..... 4" THREE JAW ADJUSTABLE PULLER.....	1
KT170322..... 7" 2-3 JAW REVERSIBLE PULLER.....	1
KT170323..... 8" 2-3 JAW ADJUSTABLE PULLER.....	1
KT170330..... STEERING WHEEL PULLER - USA.....	1
KT170344..... HARMONIC BALANCER PULLER - USA.....	1
KT170365..... PITMAN ARM PULLER - USA.....	1
KT170383..... BEARING SEPARATOR 1-1/4" - 2-1/4".....	1
KT170384..... BEARING SEPARATOR 3" - 4-1/2".....	1
KTIHOOK2..... HOOKS.....	10
KTIOL0833..... DISPLAY OVERLAY.....	1
KTIOLF04333..... OVERLAY FASTENERS (6 PACK).....	1

KTI0834

Popular Tools #1

Display assortments include the following hardware:

- Hooks, printed overlay, overlay fasteners
- Display boards must be purchased separately (KTI098)



Popular Tools #1	Qty
KTI21002.....	1/4" DR 2" EXTENSION..... 1
KTI21004.....	1/4" DR 4" EXTENSION..... 1
KTI21006.....	1/4" DR 6" EXTENSION..... 1
KTI21050.....	UNIVERSAL JOINT 1/4" DR..... 1
KTI21055.....	ADAPTER 1/4" F X 3/8" M..... 1
KTI21060.....	1/4" DR SPINNER HANDLE..... 1
KTI21091.....	1/4" DR RATCHET..... 1
KTI21092.....	1/4" DR PRO RATCHET..... 1
KTI21106.....	1/4" DR SHORT SOCKET 3/16"..... 1
KTI21107.....	1/4" DR SHORT SOCKET 7/32"..... 1
KTI21108.....	1/4" DR SHORT SOCKET 1/4"..... 1
KTI21109.....	1/4" DR SHORT SOCKET 9/32"..... 1
KTI21110.....	1/4" DR SHORT SOCKET 5/16"..... 1
KTI21111.....	1/4" DR SHORT SOCKET 11/32"..... 1
KTI21112.....	1/4" DR SHORT SOCKET 3/8"..... 1
KTI21114.....	1/4" DR SHORT SOCKET 7/16"..... 1
KTI21116.....	1/4" DR SHORT SOCKET 1/2"..... 1
KTI21118.....	1/4" DR SHORT SOCKET 9/16"..... 1
KTI21206.....	1/4" DR DEEP SOCKET 3/16"..... 1
KTI21207.....	1/4" DR DEEP SOCKET 7/32"..... 1
KTI21208.....	1/4" DR DEEP SOCKET 1/4"..... 1
KTI21209.....	1/4" DR DEEP SOCKET 9/32"..... 1
KTI21210.....	1/4" DR DEEP SOCKET 5/16"..... 1
KTI21211.....	1/4" DR DEEP SOCKET 11/32"..... 1
KTI21212.....	1/4" DR DEEP SOCKET 3/8"..... 1
KTI21214.....	1/4" DR DEEP SOCKET 7/16"..... 1
KTI21216.....	1/4" DR DEEP SOCKET 1/2"..... 1
KTI21218.....	1/4" DR DEEP SOCKET 9/16"..... 1
KTI22003.....	3/8" DR EXTENSION 3"..... 1
KTI22006.....	3/8" DR EXTENSION 6"..... 1
KTI22008.....	3/8" DR EXTENSION 8"..... 1
KTI22050.....	ADAPTER 1/2" F X 3/8" M..... 1
KTI22055.....	ADAPTER 3/8" F X 1/2" M..... 1
KTI22060.....	ADAPTER 3/8" F X 1/4" M..... 1
KTI22075.....	ADAPTER 1/2" F X 3/4" M..... 1
KTI22091.....	3/8" DR PUSH BUTTON RATCHET..... 1
KTI22092.....	3/8" DR PRO RATCHET..... 1
KTI22110.....	3/8" DR SHORT SOCKET 5/16"..... 1
KTI22112.....	3/8" DR SHORT SOCKET 3/8"..... 1
KTI22114.....	3/8" DR SHORT SOCKET 7/16"..... 1
KTI22116.....	3/8" DR SHORT SOCKET 1/2"..... 1
KTI22118.....	3/8" DR SHORT SOCKET 9/16"..... 1
KTI22120.....	3/8" DR SHORT SOCKET 5/8"..... 1
KTI22122.....	3/8" DR SHORT SOCKET 11/16"..... 1
KTI22124.....	3/8" DR SHORT SOCKET 3/4"..... 1
KTI22126.....	3/8" DR SHORT SOCKET 13/16"..... 1
KTI22128.....	3/8" DR SHORT SOCKET 7/8"..... 1
KTI22130.....	3/8" DR SHORT SOCKET 15/16"..... 1
KTI22132.....	3/8" DR SHORT SOCKET 1"..... 1
KTI22212.....	3/8" DR DEEP SOCKET 3/8"..... 1
KTI22214.....	3/8" DR DEEP SOCKET 7/16"..... 1
KTI22216.....	3/8" DR DEEP SOCKET 1/2"..... 1
KTI22218.....	3/8" DR DEEP SOCKET 9/16"..... 1
KTI22220.....	3/8" DR DEEP SOCKET 5/8"..... 1
KTI22222.....	3/8" DR DEEP SOCKET 11/16"..... 1
KTI22224.....	3/8" DR DEEP SOCKET 3/4"..... 1
KTI22226.....	3/8" DR DEEP SOCKET 13/16"..... 1
KTI22228.....	3/8" DR DEEP SOCKET 7/8"..... 1
KTI22230.....	3/8" DR DEEP SOCKET 15/16"..... 1
KTI22232.....	3/8" DR DEEP SOCKET 1"..... 1
KTI22500.....	UNIVERSAL JOINT 3/8" DR..... 1
KTI23003.....	1/2" DR 3" EXTENSION..... 1
KTI23005.....	1/2" DR 5" EXTENSION..... 1
KTI23010.....	1/2" DR 10" EXTENSION..... 1
KTI23091.....	1/2" DR PUSH BUTTON RATCHET..... 1



Popular Tools #1	Qty
KTI23092.....	1/2" DR PRO RATCHET..... 1
KTI23116.....	1/2" DR SHORT SOCKET 1/2"..... 1
KTI23118.....	1/2" DR SHORT SOCKET 9/16"..... 1
KTI23120.....	1/2" DR SHORT SOCKET 5/8"..... 1
KTI23122.....	1/2" DR SHORT SOCKET 11/16"..... 1
KTI23124.....	1/2" DR SHORT SOCKET 3/4"..... 1
KTI23126.....	1/2" DR SHORT SOCKET 13/16"..... 1
KTI23128.....	1/2" DR SHORT SOCKET 7/8"..... 1
KTI23130.....	1/2" DR SHORT SOCKET 15/16"..... 1
KTI23132.....	1/2" DR SHORT SOCKET 1"..... 1
KTI23134.....	1/2" DR SHORT SOCKET 1-1/16"..... 1
KTI23136.....	1/2" DR SHORT SOCKET 1-1/8"..... 1
KTI23140.....	1/2" DR SHORT SOCKET 1-1/4"..... 1
KTI23216.....	1/2" DR DEEP SOCKET 1/2"..... 1
KTI23218.....	1/2" DR DEEP SOCKET 9/16"..... 1
KTI23220.....	1/2" DR DEEP SOCKET 5/8"..... 1
KTI23222.....	1/2" DR DEEP SOCKET 11/16"..... 1
KTI23224.....	1/2" DR DEEP SOCKET 3/4"..... 1
KTI23226.....	1/2" DR DEEP SOCKET 13/16"..... 1
KTI23228.....	1/2" DR DEEP SOCKET 7/8"..... 1
KTI23230.....	1/2" DR DEEP SOCKET 15/16"..... 1
KTI23232.....	1/2" DR DEEP SOCKET 1"..... 1
KTI23234.....	1/2" DR DEEP SOCKET 1-1/16"..... 1
KTI23236.....	1/2" DR DEEP SOCKET 1-1/8"..... 1
KTI23240.....	1/2" DR DEEP SOCKET 1-1/4"..... 1
KTI23500.....	UNIVERSAL JOINT 1/2" DR..... 1
KTI089.....	3" EXTENSION BAR..... 1
KTIH00K2.....	HOOKS..... 47
KTIH00K11.....	PLASTIC HOOKS..... 11
KTIOL0834.....	DISPLAY OVERLAY..... 1
KTIOLF04333.....	OVERLAY FASTENERS (6 PACK)..... 1



DISPLAYS

KTI0835

Popular Tools #2

Display assortments include the following hardware:

- Hooks, printed overlay, overlay fasteners
- Display boards must be purchased separately (KTI098)



Popular Tools #2..... Qty

KTI22221.....	SPARK PLUG SOCKET 3/8" DR 5/8"	1
KTI22227.....	SPARK PLUG SOCKET 3/8" DR 13/16"	1
KTI26105.....	1/4" DR SHORT SOCKET 5MM	1
KTI26106.....	1/4" DR SHORT SOCKET 6MM	1
KTI26107.....	1/4" DR SHORT SOCKET 7MM	1
KTI26108.....	1/4" DR SHORT SOCKET 8MM	1
KTI26109.....	1/4" DR SHORT SOCKET 9MM	1
KTI26110.....	1/4" DR SHORT SOCKET 10MM	1
KTI26111.....	1/4" DR SHORT SOCKET 11MM	1
KTI26112.....	1/4" DR SHORT SOCKET 12MM	1
KTI26113.....	1/4" DR SHORT SOCKET 13MM	1
KTI26114.....	1/4" DR SHORT SOCKET 14MM	1
KTI26115.....	1/4" DR SHORT SOCKET 15MM	1
KTI26155.....	1/4" DR SHORT SOCKET 5.5MM	1
KTI26206.....	1/4" DR DEEP SOCKET 6MM	1
KTI26207.....	1/4" DR DEEP SOCKET 7MM	1
KTI26208.....	1/4" DR DEEP SOCKET 8MM	1
KTI26209.....	1/4" DR DEEP SOCKET 9MM	1
KTI26210.....	1/4" DR DEEP SOCKET 10MM	1
KTI26211.....	1/4" DR DEEP SOCKET 11MM	1
KTI26212.....	1/4" DR DEEP SOCKET 12MM	1
KTI26213.....	1/4" DR DEEP SOCKET 13MM	1
KTI26214.....	1/4" DR DEEP SOCKET 14MM	1
KTI26215.....	1/4" DR DEEP SOCKET 15MM	1
KTI26255.....	1/4" DR DEEP SOCKET 5.5MM	1
KTI27108.....	3/8" DR SHORT SOCKET 8MM	1
KTI27109.....	3/8" DR SHORT SOCKET 9MM	1
KTI27110.....	3/8" DR SHORT SOCKET 10MM	1
KTI27111.....	3/8" DR SHORT SOCKET 11MM	1
KTI27112.....	3/8" DR SHORT SOCKET 12MM	1
KTI27113.....	3/8" DR SHORT SOCKET 13MM	1
KTI27114.....	3/8" DR SHORT SOCKET 14MM	1
KTI27115.....	3/8" DR SHORT SOCKET 15MM	1
KTI27116.....	3/8" DR SHORT SOCKET 16MM	1
KTI27117.....	3/8" DR SHORT SOCKET 17MM	1
KTI27118.....	3/8" DR SHORT SOCKET 18MM	1
KTI27119.....	3/8" DR SHORT SOCKET 19MM	1
KTI27210.....	3/8" DR DEEP SOCKET 10MM	1
KTI27211.....	3/8" DR DEEP SOCKET 11MM	1
KTI27212.....	3/8" DR DEEP SOCKET 12MM	1
KTI27213.....	3/8" DR DEEP SOCKET 13MM	1
KTI27214.....	3/8" DR DEEP SOCKET 14MM	1
KTI27215.....	3/8" DR DEEP SOCKET 15MM	1
KTI27216.....	3/8" DR DEEP SOCKET 16MM	1
KTI27217.....	3/8" DR DEEP SOCKET 17MM	1
KTI27218.....	3/8" DR DEEP SOCKET 18MM	1
KTI27219.....	3/8" DR DEEP SOCKET 19MM	1
KTI28110.....	1/2" DR SHORT SOCKET 10MM	1
KTI28111.....	1/2" DR SHORT SOCKET 11MM	1
KTI28112.....	1/2" DR SHORT SOCKET 12MM	1
KTI28113.....	1/2" DR SHORT SOCKET 13MM	1
KTI28114.....	1/2" DR SHORT SOCKET 14MM	1
KTI28115.....	1/2" DR SHORT SOCKET 15MM	1
KTI28116.....	1/2" DR SHORT SOCKET 16MM	1
KTI28117.....	1/2" DR SHORT SOCKET 17MM	1
KTI28118.....	1/2" DR SHORT SOCKET 18MM	1
KTI28119.....	1/2" DR SHORT SOCKET 19MM	1
KTI28120.....	1/2" DR SHORT SOCKET 20MM	1
KTI28121.....	1/2" DR SHORT SOCKET 21MM	1
KTI28210.....	1/2" DR DEEP SOCKET 10MM	1
KTI28211.....	1/2" DR DEEP SOCKET 11MM	1
KTI28212.....	1/2" DR DEEP SOCKET 12MM	1
KTI28213.....	1/2" DR DEEP SOCKET 13MM	1
KTI28214.....	1/2" DR DEEP SOCKET 14MM	1
KTI28215.....	1/2" DR DEEP SOCKET 15MM	1

Popular Tools #2..... Qty

KTI28216.....	1/2" DR DEEP SOCKET 16MM	1
KTI28217.....	1/2" DR DEEP SOCKET 17MM	1
KTI28218.....	1/2" DR DEEP SOCKET 18MM	1
KTI28219.....	1/2" DR DEEP SOCKET 19MM	1
KTI28220.....	1/2" DR DEEP SOCKET 20MM	1
KTI28221.....	1/2" DR DEEP SOCKET 21MM	1
KTI41108.....	COMBINATION WRENCH 1/4"	1
KTI41110.....	COMBINATION WRENCH 5/16"	1
KTI41112.....	COMBINATION WRENCH 3/8"	2
KTI41114.....	COMBINATION WRENCH 7/16"	2
KTI41116.....	COMBINATION WRENCH 1/2"	3
KTI41118.....	COMBINATION WRENCH 9/16"	3
KTI41120.....	COMBINATION WRENCH 5/8"	2
KTI41122.....	COMBINATION WRENCH 11/16"	1
KTI41124.....	COMBINATION WRENCH 3/4"	2
KTI41126.....	COMBINATION WRENCH 13/16"	1
KTI41128.....	COMBINATION WRENCH 7/8"	1
KTI41130.....	COMBINATION WRENCH 15/16"	1
KTI41132.....	COMBINATION WRENCH 1"	1
KTI41134.....	COMBINATION WRENCH 1-1/16"	1
KTI41136.....	COMBINATION WRENCH 1-1/8"	1
KTI41608.....	COMBINATION WRENCH 8MM	1
KTI41609.....	COMBINATION WRENCH 9MM	1
KTI41610.....	COMBINATION WRENCH 10MM	2
KTI41611.....	COMBINATION WRENCH 11MM	2
KTI41612.....	COMBINATION WRENCH 12MM	2
KTI41613.....	COMBINATION WRENCH 13MM	2
KTI41614.....	COMBINATION WRENCH 14MM	2
KTI41615.....	COMBINATION WRENCH 15MM	2
KTI41616.....	COMBINATION WRENCH 16MM	2
KTI41617.....	COMBINATION WRENCH 17MM	2
KTI41618.....	COMBINATION WRENCH 18MM	2
KTI41619.....	COMBINATION WRENCH 19MM	2
KTI44412.....	3/8" X 7/16" FLARE NUT WRENCH	1
KTI44416.....	1/2" X 9/16" FLARE NUT WRENCH	1
KTI44420.....	5/8" X 11/16" FLARE NUT WRENCH	1
KTI089.....	3" EXTENSION BAR	1
KTIHOOK2.....	HOOKS	57
KTIHOOK11.....	PLASTIC HOOKS	14
KTIOL0835.....	DISPLAY OVERLAY	1
KTIOLF04333.....	OVERLAY FASTENERS (6 PACK)	1

KTI0836

Nutdrivers & Hex Keys

Display assortments include the following hardware:

- Hooks, printed overlay, overlay fasteners
- **Display boards must be purchased separately (KTI098)**



Nutdrivers & Hex Keys	Qty	
KTI14400	7-PIECE FRACTIONAL NUTDRIVER SET	1
KTI14406	3/16" x 3" FRACTIONAL NUTDRIVER	1
KTI14408	1/4" x 3" FRACTIONAL NUTDRIVER	1
KTI14410	5/16" x 3" FRACTIONAL NUTDRIVER	1
KTI14411	11/32" x 3" FRACTIONAL NUTDRIVER	1
KTI14412	3/8" x 3" FRACTIONAL NUTDRIVER	1
KTI14414	7/16" x 3" FRACTIONAL NUTDRIVER	1
KTI14416	1/2" x 3" FRACTIONAL NUTDRIVER	1
KTI14500	7-PIECE METRIC NUTDRIVER SET	1
KTI14505	5MM x 75MM METRIC NUTDRIVER	1
KTI14506	6MM x 75MM METRIC NUTDRIVER	1
KTI14507	7MM x 75MM METRIC NUTDRIVER	1
KTI14508	8MM x 75MM METRIC NUTDRIVER	1
KTI14509	9MM x 75MM METRIC NUTDRIVER	1
KTI14510	10MM x 75MM METRIC NUTDRIVER	1
KTI14511	11MM x 75MM METRIC NUTDRIVER	1
KTI70040	SPIRAL EXTRACTOR SET	1
KTI70070	4-PIECE PICK SET (NEON ORANGE)	1
KTI70075	4-PIECE PICK SET (NEON GREEN)	1
KTI71400	HEX KEY SET 1/8" - 3/8" FOLDING	1
KTI71420	HEX KEY SET 1/16" - 3/8" ON A RING	1
KTI71475	HEX KEY SET 2.5MM - 10MM FOLDING	1
KTI71480	HEX KEY SET 1.5MM - 10MM ON A RING	1
KTIHOOK2	HOOKS	20
KTIOL0836	DISPLAY OVERLAY	1
KTIOLF04333	OVERLAY FASTENERS (6 PACK)	1

KTI0837

Oil Filter Wrenches

Display assortments include the following hardware:

- Hooks, printed overlay, overlay fasteners
- **Display boards must be purchased separately (KTI098)**



Oil Filter Wrenches	Qty	
KTI73600	4-IN-1 FILTER WRENCH	1
KTI73601	OIL FILTER WRENCH FOR TRUCKS ADJ FROM 2-7/8"-3-1/4"	1
KTI73602	OIL FILTER WRENCH FOR TRUCKS ADJ FROM 3-7/16"-3-3/4"	1
KTI73603	OIL FILTER WRENCH FOR TRUCKS ADJ FROM 4"-4-3/8"	1
KTI73605	OIL FILTER WRENCH FOR TRUCKS ADJ FROM 4-5/16"-4-3/4"	1
KTI73606	OIL FILTER WRENCH FOR TRUCKS ADJ FROM 5-1/4"-5-3/4"	1
KTI73618	OIL FILTER CAP SOCKET 32MM	1
KTI73619	OIL FILTER CAP SOCKET 35-36MM	1
KTI73620	OIL FILTER PLIERS - ADJUSTABLE	1
KTI73621	TRUCK AND TRACTOR FILTER PLIER	1
KTI73630	OIL FILTER WRENCH TOYOTA/LEXUS	1
KTI73635	17 PC MASTER OIL FILTER WRENCH KIT	1
KTI73730	FILTER WRENCH NYLON STRAP 1/2"	1
KTI73731	HEAVY-DUTY STRAP OIL FILTER WRENCH	1
KTI089	3" EXTENSION BAR	1
KTIHOOK2	HOOKS	11
KTIHOOK11	PLASTIC HOOKS	5
KTIOL0837	DISPLAY OVERLAY	1
KTIOLF04333	OVERLAY FASTENERS (6 PACK)	1

DISPLAYS

KTI0838

Pullers & Separators

Display assortments include the following hardware:

- Hooks, printed overlay, overlay fasteners
- Display boards must be purchased separately (KTI098)



KTI0839

3/8" & 1/2" Drive Impact Sockets

Display assortments include the following hardware:

- Hooks, printed overlay, overlay fasteners
- Display boards must be purchased separately (KTI098)



Pullers & Separators	Qty
KTI70301..... 3" TWO-JAW TWO-TON PULLER	1
KTI70302..... 3" TWO/THREE-JAW TWO-TON PULLER	1
KTI70303..... 4" TWO-JAW FIVE-TON PULLER	1
KTI70304..... 3" TWO/THREE-JAW FIVE-TON PULLER	1
KTI70305..... 6" TWO-JAW FIVE-TON PULLER	1
KTI70306..... 6" TWO/THREE-JAW FIVE-TON PULLER	1
KTI70348..... STEERING WHEEL PULLER	1
KTI70383..... BEARING SEPARATOR 1 1/4"-2 1/4"	1
KTI70384..... BEARING SEPARATOR 3"-4 1/2"	1
KTIHOOK2..... HOOKS	11
KTIOL0838..... DISPLAY OVERLAY	1
KTIOLF04333..... OVERLAY FASTENERS (6 PACK)	1

3/8" & 1/2" Drive Impact Sockets	Qty
KTI32012..... Impact Universal Joint 3/8" Drive	1
KTI32016..... 3/8" Female x 1/2" Male Impact Adapter	1
KTI32110..... Socket Impact 3/8" Drive 5/16"	1
KTI32112..... Socket Impact 3/8" Drive 3/8"	1
KTI32114..... Socket Impact 3/8" Drive 7/16"	1
KTI32116..... Socket Impact 3/8" Drive 1/2"	1
KTI32118..... Socket Impact 3/8" Drive 9/16"	1
KTI32120..... Socket Impact 3/8" Drive 5/8"	1
KTI32122..... Socket Impact 3/8" Drive 11/16"	1
KTI32124..... Socket Impact 3/8" Drive 3/4"	1
KTI32126..... Socket Impact 3/8" Drive 13/16"	1
KTI32128..... Socket Impact 3/8" Drive 7/8"	1
KTI32210..... Socket Impact Deep 3/8" Drive 5/16"	1
KTI32212..... Socket Impact Deep 3/8" Drive 3/8"	1
KTI32214..... Socket Impact Deep 3/8" Drive 7/16"	1
KTI32216..... Socket Impact Deep 3/8" Drive 1/2"	1
KTI32218..... Socket Impact Deep 3/8" Drive 9/16"	1
KTI32220..... Socket Impact Deep 3/8" Drive 5/8"	1
KTI32222..... Socket Impact Deep 3/8" Drive 11/16"	1
KTI32224..... Socket Impact Deep 3/8" Drive 3/4"	1
KTI32226..... Socket Impact Deep 3/8" Drive 13/16"	1
KTI32228..... Socket Impact Deep 3/8" Drive 7/8"	1
KTI33003..... 1/2" Drive Impact Extension 3"	1
KTI33006..... 1/2" Drive Impact Extension 6"	1
KTI33012..... 1/2" Female x 3/8" Male Impact Adapter	1
KTI33016..... 1/2" Drive Universal Joint Impact	1
KTI33024..... 1/2" Female x 3/4" Male Impact Adapter	1
KTI33041..... 1/2" Female x 3/8" Male Wobble Adapter	1
KTI33050..... Socket Impact 1/2" Drive Flip 3/4" x 13/16"	1

3/8" & 1/2" Drive Impact Sockets Qty

KTI33112.....	Socket 1/2" Drive Short Impact 3/8"	1
KTI33114.....	Socket 1/2" Drive Short Impact 7/16"	1
KTI33116.....	Socket 1/2" Drive Short Impact 1/2"	1
KTI33118.....	Socket 1/2" Drive Short Impact 9/16"	1
KTI33120.....	Socket 1/2" Drive Short Impact 5/8"	1
KTI33122.....	Socket 1/2" Drive Short Impact 11/16"	1
KTI33124.....	Socket 1/2" Drive Short Impact 3/4"	1
KTI33126.....	Socket 1/2" Drive Short Impact 13/16"	1
KTI33128.....	Socket 1/2" Drive Short Impact 7/8"	1
KTI33130.....	Socket 1/2" Drive Short Impact 15/16"	1
KTI33132.....	Socket 1/2" Drive Short Impact 1"	1
KTI33134.....	Socket 1/2" Drive Short Impact 1-1/16"	1
KTI33136.....	Socket 1/2" Drive Short Impact 1-1/8"	1
KTI33138.....	Socket 1/2" Drive Short Impact 1-3/16"	1
KTI33140.....	Socket 1/2" Drive Short Impact 1-1/4"	1
KTI33142.....	Socket 1/2" Drive Short Impact 1-5/16"	1
KTI33144.....	Socket 1/2" Drive Short Impact 1-3/8"	1
KTI33146.....	Socket 1/2" Drive Short Impact 1-7/16"	1
KTI33148.....	Socket 1/2" Drive Short Impact 1-1/2"	1
KTI33212.....	Socket 1/2" Drive Impact Deep 3/8"	1
KTI33214.....	Socket 1/2" Drive Impact Deep 7/16"	1
KTI33216.....	Socket 1/2" Drive Impact Deep 1/2"	1
KTI33218.....	Socket 1/2" Drive Impact Deep 9/16"	1
KTI33220.....	Socket 1/2" Drive Impact Deep 5/8"	1
KTI33222.....	Socket 1/2" Drive Impact Deep 11/16"	1
KTI33224.....	Socket 1/2" Drive Impact Deep 3/4"	1
KTI33226.....	Socket 1/2" Drive Impact Deep 13/16"	1
KTI33228.....	Socket 1/2" Drive Impact Deep 7/8"	1
KTI33230.....	Socket 1/2" Drive Impact Deep 15/16"	1
KTI33232.....	Socket 1/2" Drive Impact Deep 1"	1
KTI33234.....	Socket 1/2" Drive Impact Deep 1-1/16"	1
KTI33236.....	Socket 1/2" Drive Impact Deep 1-1/8"	1
KTI33238.....	Socket 1/2" Drive Impact Deep 1-3/16"	1
KTI33240.....	Socket 1/2" Drive Impact Deep 1-1/4"	1
KTI33242.....	Socket 1/2" Drive Impact Deep 1-5/16"	1
KTI33244.....	Socket 1/2" Drive Impact Deep 1-3/8"	1
KTI33246.....	Socket 1/2" Drive Impact Deep 1-7/16"	1
KTI33248.....	Socket 1/2" Drive Impact Deep 1-1/2"	1
KTI34016.....	3/4" Female x 1/2" Male Impact Adapter	1
KTI37108.....	Socket Impact Metric Short 3/8" Drive 8mm	1
KTI37109.....	Socket Impact Metric Short 3/8" Drive 9mm	1
KTI37110.....	Socket Impact Metric Short 3/8" Drive 10mm	1
KTI37111.....	Socket Impact Metric Short 3/8" Drive 11mm	1
KTI37112.....	Socket Impact Metric Short 3/8" Drive 12mm	1
KTI37113.....	Socket Impact Metric Short 3/8" Drive 13mm	1
KTI37114.....	Socket Impact Metric Short 3/8" Drive 14mm	1
KTI37115.....	Socket Impact Metric Short 3/8" Drive 15mm	1
KTI37116.....	Socket Impact Metric Short 3/8" Drive 16mm	1
KTI37117.....	Socket Impact Metric Short 3/8" Drive 17mm	1
KTI37118.....	Socket Impact Metric Short 3/8" Drive 18mm	1
KTI37119.....	Socket Impact Metric Short 3/8" Drive 19mm	1
KTI37208.....	Socket Deep Impact 3/8" Drive 8mm	1
KTI37209.....	Socket Deep Impact 3/8" Drive 9mm	1
KTI37210.....	Socket Deep Impact 3/8" Drive 10mm	1
KTI37211.....	Socket Deep Impact 3/8" Drive 11mm	1
KTI37212.....	Socket Deep Impact 3/8" Drive 12mm	1
KTI37213.....	Socket Deep Impact 3/8" Drive 13mm	1
KTI37214.....	Socket Deep Impact 3/8" Drive 14mm	1
KTI37215.....	Socket Deep Impact 3/8" Drive 15mm	1
KTI37216.....	Socket Deep Impact 3/8" Drive 16mm	1

3/8" & 1/2" Drive Impact Sockets Qty

KTI37217.....	Socket Deep Impact 3/8" Drive 17mm	1
KTI37218.....	Socket Deep Impact 3/8" Drive 18mm	1
KTI37219.....	Socket Deep Impact 3/8" Drive 19mm	1
KTI38050.....	Socket Impact 1/2" Drive Flip 19mm x 21mm	1
KTI38110.....	Socket 1/2" Drive Short Impact 10mm	1
KTI38111.....	Socket 1/2" Drive Short Impact 11mm	1
KTI38112.....	Socket 1/2" Drive Short Impact 12mm	1
KTI38113.....	Socket 1/2" Drive Short Impact 13mm	1
KTI38114.....	Socket 1/2" Drive Short Impact 14mm	1
KTI38115.....	Socket 1/2" Drive Short Impact 15mm	1
KTI38116.....	Socket 1/2" Drive Short Impact 16mm	1
KTI38117.....	Socket 1/2" Drive Short Impact 17mm	1
KTI38118.....	Socket 1/2" Drive Short Impact 18mm	1
KTI38119.....	Socket 1/2" Drive Short Impact 19mm	1
KTI38120.....	Socket 1/2" Drive Short Impact 20mm	1
KTI38121.....	Socket 1/2" Drive Short Impact 21mm	1
KTI38122.....	Socket Impact Metric 1/2" Drive 22mm	1
KTI38123.....	Socket Impact Metric 1/2" Drive 23mm	1
KTI38124.....	Socket Impact Metric 1/2" Drive 24mm	1
KTI38125.....	Socket Impact Metric 1/2" Drive 25mm	1
KTI38126.....	Socket Impact Metric 1/2" Drive 26mm	1
KTI38127.....	Socket Impact Metric 1/2" Drive 27mm	1
KTI38128.....	Socket Impact Metric 1/2" Drive 28mm	1
KTI38129.....	Socket Impact Metric 1/2" Drive 29mm	1
KTI38130.....	Socket Impact Metric 1/2" Drive 30mm	1
KTI38132.....	Socket Impact Metric 1/2" Drive 32mm	1
KTI38133.....	Socket Impact Metric 1/2" Drive 33mm	1
KTI38134.....	Socket Impact Metric 1/2" Drive 34mm	1
KTI38135.....	Socket Impact Metric 1/2" Drive 35mm	1
KTI38136.....	Socket Impact Metric 1/2" Drive 36mm	1
KTI38210.....	Socket 1/2" Drive Impact Deep 10mm	1
KTI38211.....	Socket 1/2" Drive Impact Deep 11mm	1
KTI38212.....	Socket 1/2" Drive Impact Deep 12mm	1
KTI38213.....	Socket 1/2" Drive Impact Deep 13mm	1
KTI38214.....	Socket 1/2" Drive Impact Deep 14mm	1
KTI38215.....	Socket 1/2" Drive Impact Deep 15mm	1
KTI38216.....	Socket 1/2" Drive Impact Deep 16mm	1
KTI38217.....	Socket 1/2" Drive Impact Deep 17mm	1
KTI38218.....	Socket 1/2" Drive Impact Deep 18mm	1
KTI38219.....	Socket 1/2" Drive Impact Deep 19mm	1
KTI38220.....	Socket 1/2" Drive Impact Deep 20mm	1
KTI38221.....	Socket 1/2" Drive Impact Deep 21mm	1
KTI38222.....	Socket 1/2" Drive Impact Deep 22mm	1
KTI38223.....	Socket 1/2" Drive Impact Deep 23mm	1
KTI38224.....	Socket 1/2" Drive Impact Deep 24mm	1
KTI38225.....	Socket 1/2" Drive Impact Deep 25mm	1
KTI38226.....	Socket 1/2" Drive Impact Deep 26mm	1
KTI38227.....	Socket 1/2" Drive Impact Deep 27mm	1
KTI38228.....	Socket 1/2" Drive Impact Deep 28mm	1
KTI38229.....	Socket 1/2" Drive Impact Deep 29mm	1
KTI38230.....	Socket 1/2" Drive Impact Deep 30mm	1
KTI38232.....	Socket Impact Metric Deep 1/2" Drive 32mm	1
KTI38233.....	Socket Impact Metric Deep 1/2" Drive 33mm	1
KTI38234.....	Socket Impact Metric Deep 1/2" Drive 34mm	1
KTI38235.....	Socket Impact Metric Deep 1/2" Drive 35mm	1
KTI38236.....	Socket Impact Metric Deep 1/2" Drive 36mm	1
KTIH00K2.....	HOOKS.....	146
KTIOL0839.....	DISPLAY OVERLAY.....	1
KTIOLF04333.....	OVERLAY FASTENERS (6 PACK).....	1

DISPLAYS

KTIO840

3/4" Drive Impact Sockets

Display assortments include the following hardware:



- Hooks, printed overlay, overlay fasteners
- Display boards must be purchased separately (KTIO98)

3/4" Drive Impact Sockets..... Qty

KT134026.....	13/16" Square Budd Wheel Socket.....	1
KT134027.....	1-1/2" - 13/16" Budd Wheel Socket 3/4" Drive.....	1
KT134032.....	3/4" Female x 1" Male Impact Adapter.....	1
KT134050.....	Universal Joint 3/4" Drive Impact.....	1
KT134132.....	Socket 3/4" Drive Short Impact 1".....	1
KT134134.....	Socket 3/4" Drive Short Impact 1-1/16".....	1
KT134136.....	Socket 3/4" Drive Short Impact 1-1/8".....	1
KT134140.....	Socket 3/4" Drive Short Impact 1-1/4".....	1
KT134142.....	Socket 3/4" Drive Short Impact 1-5/16".....	1
KT134144.....	Socket 3/4" Drive Short Impact 1-3/8".....	1
KT134146.....	Socket 3/4" Drive Short Impact 1-7/16".....	1
KT134148.....	Socket 3/4" Drive Short Impact 1-1/2".....	1
KT134150.....	Socket 3/4" Drive Short Impact 1-9/16".....	1
KT134152.....	Socket 3/4" Drive Short Impact 1-5/8".....	1
KT134154.....	Socket 3/4" Drive Short Impact 1-11/16".....	1
KT134156.....	Socket 3/4" Drive Short Impact 1-3/4".....	1
KT134158.....	Socket 3/4" Drive Short Impact 1-13/16".....	1
KT134160.....	Socket 3/4" Drive Short Impact 1-15/16".....	1
KT134162.....	Socket 3/4" Drive Short Impact 1-7/8".....	1
KT134164.....	Socket 3/4" Drive Short Impact 2".....	1
KT134166.....	Socket 3/4" Drive Short Impact 2-1/16".....	1
KT134168.....	Socket 3/4" Drive Short Impact 2-1/8".....	1
KT134172.....	Socket 3/4" Drive Short Impact 2-1/4".....	1
KT134176.....	Socket 3/4" Drive Short Impact 2-3/8".....	1
KT134232.....	Socket 3/4" Drive Deep Impact 1".....	1
KT134234.....	Socket 3/4" Drive Deep Impact 1-1/16".....	1
KT134236.....	Socket 3/4" Drive Deep Impact 1-1/8".....	1
KT134240.....	Socket 3/4" Drive Deep Impact 1-1/4".....	1
KT134242.....	Socket 3/4" Drive Deep Impact 1-5/16".....	1
KT134244.....	Socket 3/4" Drive Deep Impact 1-3/8".....	1
KT134246.....	Socket 3/4" Drive Deep Impact 1-7/16".....	1
KT134248.....	Socket 3/4" Drive Deep Impact 1-1/2".....	1
KT134250.....	Socket 3/4" Drive Deep Impact 1-9/16".....	1
KT134252.....	Socket 3/4" Drive Deep Impact 1-5/8".....	1
KT134254.....	Socket 3/4" Drive Deep Impact 1-11/16".....	1
KT134256.....	Socket 3/4" Drive Deep Impact 1-3/4".....	1
KT134258.....	Socket 3/4" Drive Deep Impact 1-13/16".....	1
KT134260.....	Socket 3/4" Drive Deep Impact 1-15/16".....	1
KT134262.....	Socket 3/4" Drive Deep Impact 1-7/8".....	1
KT134264.....	Socket 3/4" Drive Deep Impact 2".....	1
KT135024.....	1" Female x 3/4" Male Impact Adapter.....	1
KT135026.....	Socket Impact 1" Drive 13/16" Square Budd Wheel.....	1
KT135027.....	Socket Impact 1" Drive 1-1/2" - 13/16" Budd Wheel.....	1
KT135233.....	Socket Impact Deep 1" Drive 33mm Hex Budd Wheel.....	1
KT1H00K8.....	HOOKS.....	30
KTIO88.....	PLEXIGLASS SHELF.....	6
KTIOLO840.....	DISPLAY OVERLAY.....	1
KTIOLF04333.....	OVERLAY FASTENERS (6 PACK).....	1





KT10842
Reversible Ratcheting Wrenches W*
 Display assortments include the following hardware:
 • Hooks, printed overlay, overlay fasteners
 • Display boards must be purchased separately (KT1098)

Reversible Ratcheting Wrenches.....	Qty
KT145608..... Wrench Metric Ratcheting Reversible 8mm.....	1
KT145609..... Wrench Metric Ratcheting Reversible 9mm.....	1
KT145610..... Wrench Metric Ratcheting Reversible 10mm.....	1
KT145611..... Wrench Metric Ratcheting Reversible 11mm.....	1
KT145612..... Wrench Metric Ratcheting Reversible 12mm.....	1
KT145613..... Wrench Metric Ratcheting Reversible 13mm.....	1
KT145614..... Wrench Metric Ratcheting Reversible 14mm.....	1
KT145615..... Wrench Metric Ratcheting Reversible 15mm.....	1
KT145616..... Wrench Metric Ratcheting Reversible 16mm.....	1
KT145617..... Wrench Metric Ratcheting Reversible 17mm.....	1
KT145618..... Wrench Metric Ratcheting Reversible 18mm.....	1
KT145619..... Wrench Metric Ratcheting Reversible 19mm.....	1
KT145620..... Wrench Metric Ratcheting Reversible 20mm.....	1
KT145621..... Wrench Metric Ratcheting Reversible 21mm.....	1
KT145622..... Wrench Metric Ratcheting Reversible 22mm.....	1
KT145624..... Wrench Metric Ratcheting Reversible 24mm.....	1
KT145908..... Wrench SAE Ratcheting Reversible 1/4".....	1
KT145910..... Wrench SAE Ratcheting Reversible 5/16".....	1
KT145912..... Wrench SAE Ratcheting Reversible 3/8".....	1
KT145914..... Wrench SAE Ratcheting Reversible 7/16".....	1
KT145916..... Wrench SAE Ratcheting Reversible 1/2".....	1
KT145918..... Wrench SAE Ratcheting Reversible 9/16".....	1
KT145920..... Wrench SAE Ratcheting Reversible 5/8".....	1
KT145922..... Wrench SAE Ratcheting Reversible 11/16".....	1
KT145924..... Wrench SAE Ratcheting Reversible 3/4".....	1
KT145926..... Wrench SAE Ratcheting Reversible 13/16".....	1
KT145928..... Wrench SAE Ratcheting Reversible 7/8".....	1
KT145930..... Wrench SAE Ratcheting Reversible 15/16".....	1
KT145932..... Wrench SAE Ratcheting Reversible 1".....	1
KT1089..... 3" EXTENSION BAR.....	2
KT1HOOK2..... HOOKS.....	15
KT1HOOK11..... PLASTIC HOOKS.....	14
KT1OL0842..... DISPLAY OVERLAY.....	1
KT1OLF04333..... OVERLAY FASTENERS (6 PACK).....	1

KT10843
Electrical & Hardware Component Assortment

Display assortments include the following hardware:
 • Display board, overlay, fastener and shelves must be purchased separately (KT1005) W*



Electrical & Hardware Component Assortment	Qty
KT100071..... Hitch Pin Assortment (15 Piece).....	1
KT100072..... E Clip Assortment (300 Piece).....	1
KT100074..... Hydraulic Grease Fitting Assortment (110 Piece).....	1
KT100075..... Cotter Pin Assortment (555 Piece).....	1
KT100078..... Cotter Pin Assortment (144 Piece).....	1
KT100080..... Auto Fuse Assortment (120 Piece).....	1
KT100081..... Mini Fuse Assortment (120 Piece).....	2
KT100086..... O-Ring Assortment HNBR (270 Piece).....	1
KT100087..... Terminal Assortment (360 Piece).....	1
KT100089..... Washer Assortment Copper (110 Piece).....	1
KT100093..... Roll Pin Assortment (120 Piece).....	1
KT100094..... O-Ring Assortment Universal (407 Piece).....	1
KT100095..... Metric O-Ring Assortment (419 Piece).....	1
KT100096..... Grease Fitting Assortment Metric (110 Piece).....	1
KT100097..... Electric Wire Solderless Terminal Kit (157 Piece).....	1
KT107740..... Heat Shrink Tube Kit (235 Piece).....	1

DISPLAYS

KTI0844 Pipe Wrenches

W*

NEW

Display assortments include the following hardware:

- Hooks, printed overlay, overlay fasteners
- Display boards must be purchased separately (KTI098)

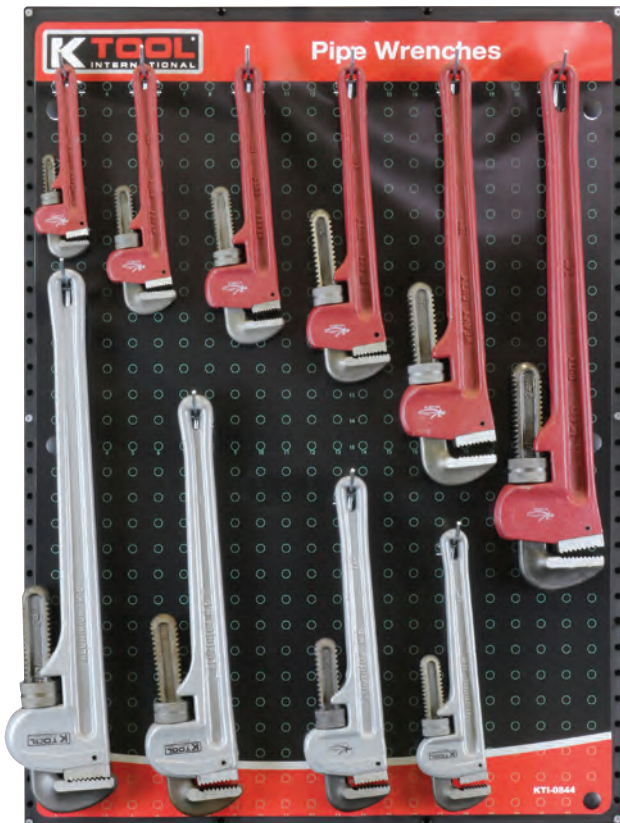

Pipe Wrenches.....	Qty
KTI49008..... 8" PIPE WRENCH	1
KTI49010..... 10" PIPE WRENCH	1
KTI49012..... 12" PIPE WRENCH	1
KTI49014..... 14" PIPE WRENCH	1
KTI49018..... 18" PIPE WRENCH	1
KTI49024..... 24" PIPE WRENCH	1
KTI49112..... 12" Aluminum Pipe Wrench	1
KTI49114..... 14" Aluminum Pipe Wrench	1
KTI49118..... 18" Aluminum Pipe Wrench	1
KTI49124..... 24" Aluminum Pipe Wrench	1
KTIHOOK2..... HOOKS.....	10
KTIOL0844..... DISPLAY OVERLAY	1
KTIOLF04333..... OVERLAY FASTENERS (6 PACK).....	1

KTI0845 Wire Tools

W*

NEW

Display assortments include the following hardware:

- Hooks, printed overlay, overlay fasteners
- Display boards must be purchased separately (KTI098)



Wire Tools	Qty
KTI00003..... Butt Connector Kit - 100 Piece	1
KTI00004..... Butt Connector Kit with Shrink	1
KTI00035..... Shrink Tube Kit- 85 Pieces.....	1
KTI00037..... Solderless Terminal Kit-180Pc.....	1
KTI56201..... Multi Purpose Crimper & Wire Str 9".....	1
KTI56202..... Multi Purpose Crimper & Wire Str 8.5".....	1
KTI56203..... Professional Crimping Tool 0.5-6.0 MM	1
KTI56204..... Professional Crimping Tool 1.5-16.0 MM	1
KTI56205..... Ratcheting Terminal Crimper	1
KTI56207..... 8-in-1 Wire Stripper.....	1
KTI56208..... Wire Stripper - Self Adjusting.....	1
KTIHOOK2..... HOOKS.....	15
KTIOL0845..... DISPLAY OVERLAY	1
KTIOLF04333..... OVERLAY FASTENERS (6 PACK).....	1

KTI0846

Torches

Display assortments include the following hardware:

- Hooks, printed overlay, overlay fasteners
- Display boards must be purchased separately (KTI098)

W*

NEW



Torches	Qty
KTI70048..... Micro Butane Turbo-Lite	2
KTI70052..... Pocket Style Butane Torch	2
KTI70054..... Mini Butane Torch with Solder	2
KTI70056..... Swivel Tube Propane Torch Head	2
KTI70057..... Self Igniting Propane Torch	2
KTI70058..... Hand-Held Pro Butane Torch	2
KTI70440..... PYRO Torch Shield 10x18	2
KTIHOOK2..... HOOKS	7
KTIOL0846..... DISPLAY OVERLAY	1
KTIOLF04333..... OVERLAY FASTENERS (6 PACK)	1

KTI0847

Lighting

Display assortments include the following hardware:

- Hooks, printed overlay, overlay fasteners
- Display boards must be purchased separately (KTI098)

W*

NEW



Lighting	Qty
KTI73379..... 30-LED SMD Retrofit Light	2
KTI73387..... Recharg Worklight 3W COB with piv head	1
KTI73388..... Rechargeable Worklight 3W COB	1
KTI73389..... LED Slimline Inspection Light	1
KTI73394..... Rechargeable 60LED Worklight	1
KTI73396..... Flashlight 16LED AAA Aluminum	1
KTI73398..... Headlamp 14 LED AAA Batteries	2
KTI73399..... LED Rechargeable Worklight 12SMD	1
KTIHOOK2..... HOOKS	13
KTIHOOK3..... HOOKS	1
KTIOL0847..... DISPLAY OVERLAY	1
KTIOLF04333..... OVERLAY FASTENERS (6 PACK)	1

DISPLAYS

KTIO848 3/4" Drive Tools

Display assortments include the following hardware:

- Hooks, printed overlay, overlay fasteners
- Display boards must be purchased separately (KTIO98)

W*

NEW

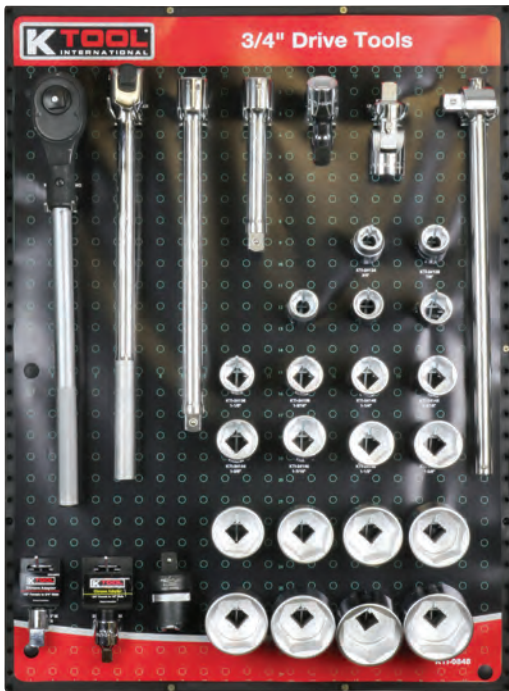

3/4" Drive Tools..... Qty

KT122075.....	1/2" FEMALE x 3/4" MALE ADAPTER.....	1
KT124004.....	3/4" DR SOCKET EXTENSION 4".....	1
KT124008.....	3/4" DR SOCKET EXTENSION 8".....	1
KT124016.....	3/4" DR CHROME EXTENSION 16".....	1
KT124050.....	3/4" FEMALE x 1/2" MALE ADAPTER.....	1
KT124070.....	3/4" DR SOCKET T-HANDLE SLIDING.....	1
KT124080.....	3/4" DR BREAKER BAR 20".....	1
KT124085.....	3/4" DR RATCHETING ADAPTER.....	1
KT124092.....	3/4" DR RATCHET HD PRO.....	1
KT124124.....	3/4" DR 6 PT SOCKET 3/4".....	1
KT124128.....	3/4" DR 6 PT SOCKET 7/8".....	1
KT124130.....	3/4" DR 6 PT SOCKET 15/16".....	1
KT124132.....	3/4" DR 6 PT SOCKET 1".....	1
KT124134.....	3/4" DR 6 PT SOCKET 1-1/16".....	1
KT124136.....	3/4" DR 6 PT SOCKET 1-1/8".....	1
KT124138.....	3/4" DR 6 PT SOCKET 1-3/16".....	1
KT124140.....	3/4" DR 6 PT SOCKET 1-1/4".....	1
KT124142.....	3/4" DR 6 PT SOCKET 1- 5/16".....	1
KT124144.....	3/4" DR 6 PT SOCKET 1-3/8".....	1
KT124146.....	3/4" DR 6 PT SOCKET 1-7/16".....	1
KT124148.....	3/4" DR 6 PT SOCKET 1-1/2".....	1
KT124152.....	3/4" DR 6 PT SOCKET 1-5/8".....	1
KT124156.....	3/4" DR 6 PT SOCKET 1-3/4".....	1
KT124160.....	3/4" DR 6 PT SOCKET 1-7/8".....	1
KT124164.....	3/4" DR 6 PT SOCKET 2".....	1
KT124166.....	3/4" DR 6 PT SOCKET 2-1/16".....	1
KT124168.....	3/4" DR 6 PT SOCKET 2-1/8".....	1
KT124170.....	3/4" DR 6 PT SOCKET 2-3/16".....	1
KT124172.....	3/4" DR 6 PT SOCKET 2-1/4".....	1
KT124176.....	3/4" DR 6 PT SOCKET 2-3/8".....	1
KT124500.....	3/4" DR UNIVERSAL JOINT.....	1
KTIH00K2.....	HOOKS.....	23
KTIH00K7.....	HOOKS.....	7
KTIH00K8.....	HOOKS.....	1
KTIOL0848.....	DISPLAY OVERLAY.....	1
KTIOLF04333.....	OVERLAY FASTENERS (6 PACK).....	1



KTIO849 1" Drive Impact Tools

Display assortments include the following hardware:

- Hooks, printed overlay, overlay fasteners
- Display boards must be purchased separately (KTIO98)

W*

NEW

1" Drive Impact Tools..... Qty

KT135005.....	1" DR BUDD WHEEL SERVICE SET 5Pc.....	1
KT135007.....	1" DR IMPACT EXTENSION 7".....	1
KT135013.....	1" DR IMPACT EXTENSION 13".....	1
KT135024.....	1" F X 3/4" M IMPACT ADAPTOR.....	1
KT135026.....	1" DR SKT IMPACT 13/16" SQ BDWHL.....	1
KT135027.....	1" DR SKT IMPACT 1-1/2"-13/16" BDWHL.....	1
KT135028.....	1" DR 1 1/2"-13/16" BUDD SKT DP.....	1
KT135124.....	1" DR SKT IMPACT SHORT 3/4".....	1
KT135126.....	1" DR SKT IMPACT SHORT 13/16".....	1
KT135128.....	1" DR SKT IMPACT SHORT 7/8".....	1
KT135130.....	1" DR SKT IMPACT SHORT 15/16".....	1
KT135132.....	1" DR SKT IMPACT SHORT 1".....	1
KT135134.....	1" DR SKT IMPACT SHORT 1-1/16".....	1
KT135136.....	1" DR SKT IMPACT SHORT 1-1/8".....	1
KT135138.....	1" DR SKT IMPACT SHORT 1-3/16".....	1
KT135140.....	1" DR SKT IMPACT SHORT 1-1/4".....	1
KT135142.....	1" DR SKT IMPACT SHORT 1-5/16".....	1
KT135146.....	1" DR SKT IMPACT SHORT 1-7/16".....	1
KT135148.....	1" DR SKT IMPACT SHORT 1-1/2".....	1
KT135152.....	1" DR SKT IMPACT SHORT 1-5/8".....	1
KT135154.....	1" DR SKT IMPACT SHORT 1-11/16".....	1
KT135158.....	1" DR SKT IMPACT SHORT 1-13/16".....	1
KT135160.....	1" DR SKT IMPACT SHORT 1-7/8".....	1
KT135164.....	1" DR SKT IMPACT SHORT 2".....	1
KT135166.....	1" DR SKT IMPACT SHORT 2-1/16".....	1
KT135172.....	1" DR SKT IMPACT SHORT 2-1/4".....	1
KT135178.....	1" DR SKT IMPACT SHORT 2-7/16".....	1
KT135184.....	1" DR SKT IMPACT SHORT 2-5/8".....	1
KT135196.....	1" DR SKT IMPACT SHORT 3".....	1
KT135233.....	1" DR SKT IMPACT DEEP 33MM HEXBDWHL.....	1
KT135234.....	1" DR SKT IMPACT DEEP 1-1/16".....	1
KT135235.....	1" DR SKT IMPACT DEEP 35MM HEXBDWHL.....	1
KT135236.....	1" DR SKT IMPACT DEEP 1-1/8".....	1
KT135238.....	1" DR SKT IMPACT DEEP 38MM HEXBDWHL.....	1
KT135240.....	1" DR SKT IMPACT DEEP 1-1/4".....	1
KT135241.....	1" DR SKT IMPACT DEEP 41MM HEXBDWHL.....	1
KT135242.....	1" DR SKT IMPACT DEEP 1-5/16".....	1
KTIH00K2.....	HOOKS.....	2
KTIH00K8.....	HOOKS.....	22
KTI088.....	PLEXIGLASS SHELF.....	4
KTIOL0849.....	DISPLAY OVERLAY.....	1
KTIOLF04333.....	OVERLAY FASTENERS (6 PACK).....	1

KTI0852
Lubrication



Display assortments include the following hardware:

- Hooks, printed overlay, overlay fasteners
- **Display boards must be purchased separately (KTI098)**

Lubrication	Qty
KTI73903..... Needle Nose Dispenser 1-1/2" Narrow	2
KTI73912..... Grease Gun Hose 12".....	2
KTI73918..... Grease Gun Hose 18".....	2
KTI73919..... Suction Gun w/12" Vinyl Hose.....	1
KTI73930..... Mini Pistol Grease Gun 3 oz	1
KTI73933..... HD Pistol Grip Grease Gun 14 oz	1
KTI73942..... HD Level Grease Gun 14 oz.....	1
KTI73952..... Prof 4 Jaw Grease Gun Coupler.....	2
KTI73957..... Grease Injector Needle.....	2
KTI73959..... Right Angle Grease Gun Coupler	2
KTIHOOK2..... HOOKS.....	11
KTIOL0852..... DISPLAY OVERLAY	1
KTIOLF04333..... OVERLAY FASTENERS (6 PACK).....	1



ACC0881
AccuTorq



Display assortments include the following hardware:

- Hooks, printed overlay, overlay fasteners
- **Display boards must be purchased separately (KTI098)**

AccuTorq	Qty
ACC10-0304..... Green 1/2 Dr 17MM 55 Ft lbs.....	1
ACC10-0305..... Red 1/2 Dr 17MM 80 Ft lbs.....	1
ACC10-0306..... Yellow 1/2 Dr 19MM 65 ft lbs	1
ACC10-0307..... Blue 1/2 Dr 19MM 80 ft lbs.....	1
ACC10-0308..... Gray 1/2 Dr 19MM 100 ft lbs	1
ACC10-0310..... Light Brown 1/2 Dr 21MM 80 ft	1
ACC10-0311..... Brown 1/2 Dr 21MM 100 ft lbs.....	1
ACC10-0312..... White 1/2 Dr 22MM 120 ft lbs.....	1
ACC10-0313..... Turq 1/2 Dr 7/8 140 ft lbs	1
ACC10-3899..... Lt Green 1/2 Dr 24MM 140 Ft lb	1
ACC10-0103D..... 8.5" x 11" ACCUTORQ CHART.....	1
KTI33317..... Socket Thnwll Prctcv 17MM Blue	1
KTI33319..... Socket Thnwll Prctcv 19MM Gold	1
KTI33321..... Socket Thnwll Prctcv 21MM Red	1
KTI33326..... Socket Thnwll Prctcv 13/16 Pur.....	1
KTI33328..... Socket Thnwll Prctcv 7/8 Green	1
KTI33332..... Socket Thnwll Prctcv 1 Titanium.....	1
KTI33334..... Socket Thnwll Prctcv 1-1/16 Bk	1
KTI33351..... Torque Ext 55 ft.lbs. Red.....	1
KTI33352..... Torque Ext 65 ft.lbs. Yellow.....	1
KTI33353..... Torque Ext 80 ft.lbs. Green	1
KTI33354..... Torque Ext 100 ft.lbs. Lt Blue.....	1
KTI33355..... Torque Ext 120 ft.lbs. White.....	1
KTI33356..... Torque Ext 140 ft.lbs. Black.....	1
KTI33357..... Torque Ext 175 ft.lbs. Orange	1
KTI72138..... 1/2" DR DIGITAL TORQUE ADAPTER.....	1
KTI78040..... 4" CABLE TIE BLACK.....	1
KTIHOOK2..... HOOKS.....	9
KTIHOOK7..... HOOKS.....	17
KTIOL0881..... DISPLAY OVERLAY	1
KTIOLF04333..... OVERLAY FASTENERS (6 PACK).....	1



DISPLAYS

Displays | Accessories

KTIHOOK7
1" Wide Round Closed Hook



KTIHOOK8
Long U-Shaped Hook



KTIOLF04333
Display Overlay Fasteners (6 pack)



KTIHOOK11
1-1/2" Plastic Hook



KTIHOOK2
2" Single Short Hook



KTIHOOK3
6" Disc-Single Long Hook



KTI087
Slanted Wire Shelf 6" x 23.5" x 12.5"



KTI088
Black Acrylic Plexiglass Shelves
• Each Shelf Dimension 24" x 3-9/16" X 3/16"
• Quantity: 1 shelf
• Hooks not included



***NOTE: Only hardware,
product shown not included**

KTI005
Assortment
Display Hardware

- Electrical & Hardware Component Assortment must be purchased separately (KTI0843)
- *NOTE: Only hardware, product shown not included

Assortment Display Hardware	Qty
KTI087..... Slanted Wire Shelf - 6" x 23.5" each	5
KTI098..... Blank Board	1
KTIOL0843..... Display Overlay	1
KTIOLF04333..... Overlay Fasteners (6 Pack)	1



KT1089
3" Display Extension Bar

Add more room to any display with the 3" extension bar. Larger product can be displayed behind the display bar with plenty of clearance for easy shopping and visual appeal. Place smaller product on the extension to maximize display space and sales!

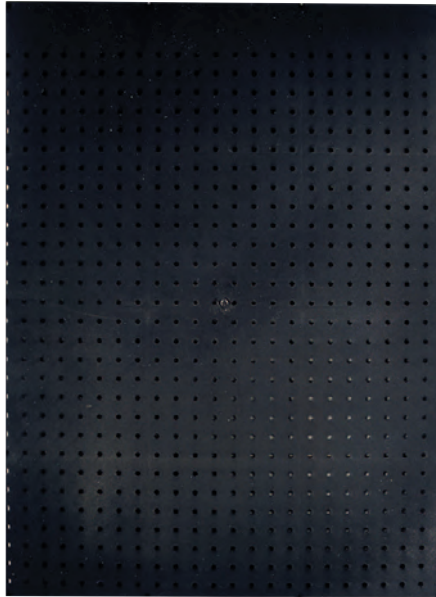

KT1098
Blank Display Board

Display boards can be used with any of the display overlay and merchandising kits or to create customized in-store merchandising programs. Blank display board measures 23.5" x 32".



KT1001
8-board
Rotary Merchandiser

KT's rotary merchandiser is the perfect way to display a maximum amount of product in a minimal amount of space. Rotary merchandiser will hold up to eight (8) displays! The rotary display requires a minimal amount of space - only 36" x 36". Display is complete with four (4) durable casters for added mobility. A must-have for professional, effective merchandising. Boards (KT1-098) sold separately.

*NOTE: Some displays are not recommended for use on the rotary merchandiser due to weight restrictions.



KT1004
Acrylic Counter Display

Acrylic counter display features a 15-11/16" x 15-13/16" display area to maximize product exposure. Compact design requires a minimal footprint (8" x 15-11/16"). A great way to generate 'impulse' buys. Utilizes 'dead' space behind point-of-sale terminals or computer monitors for additional merchandising area. Featuring two heightadjustable legs, the display area has a tilt range from 75-degrees to 87-degrees.

DISPLAYS

Displays | Floor & Counter

KTIPREPACKQ1

W*

Hand Tools Floor Display Prepack Q1

- Floor Display consisting of five prepacked KTI hand tool sets (2 each)
- (2) KTI19000 - 8Pc Screwdriver Set (Black)
- (2) KTI21044 - 44Pc Socket Set, 1/4" Drive, SAE & Metric, Shallow & Deep
- (2) KTI22047 - 47Pc Socket Set, 6 Point, 3/8" Drive SAE & Metric
- Two Wrench Sets; (2) KTI41300 - 9pc High Polish, Smooth Finish, Sizes 3/8" to 7/8" and (2) KTI41800 - 13Pc High Polish, Smooth Finish, Sizes 7mm to 19mm

Display setup size: Height: 40.9", Width: 26.3", Depth: 16.7".
All hand tools are covered by a Lifetime Warranty.

LIFETIME WARRANTY*



W*



- BluBird air hoses are heavy duty, ultra light weight and super strong. Stay flexible in temperatures from -50 to 190° fahrenheit. Ozone, UV & abrasion resistant. Covered by a 10 year warranty

- BluBird Oil Shield air hoses are ultra lightweight, extreme durability resists abrasion and ultra high strength exceeds RMA IP-2. Stay flexible in extreme conditions from -30 to 190° fahrenheit. Oil resistance core tube and cover meets RMA Class A oil resistance. Covered by a 3 year warranty

KT171005

BluBird And Oil Shield Air Hose Promo Pack

Contains 8 air hoses:

- (2) - **KT172015** - BluBird 3/8" x 50'
- (2) - **KT172018** - Oil Shield 3/8" x 50'
- (1) - **KT172049** - BluBird 3/8" x 35'
- (1) - **KT172017** - Oil Shield 3/8" x 35'
- (1) - **KT172014** - BluBird 3/8" x 25'
- (1) - **KT172048** - Oil Shield 3/8" x 25'

- Size of promotional pack on display:
Width: 24", Depth: 11", Height: 26"

W*

**KTI90003
Q-Bond Adhesive Kit,
10 Pack with Display**

- Ultra-strong adhesive and reinforcing powders
- Repairs almost anything!
- Rock solid in 10 seconds
- Q-Bond repairs are able to be grinded, filed, sanded and even painted
- Hang tabs for pegboard and rack displays
- Display measures: 11.5" x 6.25" x 6.5"



New package design with 10 kits in this display. Q-BOND can be used just as an adhesive or with the reinforcing powders that will help to repair almost anything. Q-BOND repairs can be grinded, filed, sanded, and even painted. Each Q-BOND kit includes two (2) bottles Q-BOND adhesive (0.35oz/10ml); one (1) bottle black reinforcing powder for plastics; one (1) bottle grey reinforcing powder for metals.

KTI90003C

Q-Bond Adhesive Kit - 10 Pack Display for Canada

- Display measures: 11.5" x 6.25" x 6.5"



W*

KTI73910

Lube Combo Display Shelf Pack

- Pack includes:
 - 3 each: Heavy Duty Pistol Grip Grease Guns (KTI73933)
 - 3 each: Heavy Duty Lever Grease Guns (KTI73942)
- Aluminium die cast grease gun head
- Lever grease gun develops up to 10,000 PSI; pistol grease gun up to 5000 PSI
- For use with 14 oz. grease cartridges
- Lever gun (KTI73942) includes 6" bent steel extension & coupler; pistol gun (KTI73933) includes 18" flexible grease hose & coupler
- Covered by a 1-year warranty
- Display shelf pack measures: 6" x 11.5" x 16"

Cut case shelf pack includes K-Tool International's most popular lever & pistol grip grease guns. Each pack includes 3 of each grease gun type.

W*

**KTI73952-54
Grease Gun Coupler
54 Pack Counter Display**

- 6,000 PSI
- For use with hand grease guns only
- 1-Year Warranty
- Counter display measures: 5.5" x 4.5" x 4.25"



W*



**KTI70038-10
Combi Wedge 10 Pack**

- Counter display 10 pack of the heavy duty universal combination wedge tool
- Use on dashboards and door cover clips
- Color: Red
- Tool length: 8.5", width: 1", height: 1"
- Covered by a 1 year warranty
- Counter display measures: Height: 7.0" Width: 11.750", Depth: 7.50"

W*



**KTI70037-10
Clip Lifter**

- Clip lifter for plastic fasteners, upholstery, door panels, plastic clips
- Tool length: 7" • Tool width: 3/4"
- Red rubber handle
- Counter display measures: 9-1/2" wide, 7" deep and 5" high
- Covered by a 1-Year Warranty

PART NUMBER INDEX

Part # Page#

ABD6-102.....118; 119; 122; 123
 ABD6-103.....118; 119; 122; 123
 ABD6-106.....118; 122; 123
 ABD6-108.....118; 119; 122; 123
 ABD6-109.....118; 119; 121;
 122; 123
 ABD6-110.....118; 119; 121;
 122; 123
 ABD6-111.....118; 119; 122; 123
 ABD6-112.....118; 123
 ABD6-115.....118; 119; 122; 123
 ABD6-116.....118; 119; 122; 123
 ABD6-117.....118; 123
 ABD6-120.....118; 119; 122; 123
 ABD6-122.....118; 119; 122; 123
 ABD6-125.....118; 123
 ABD6-127.....118; 119; 122; 123
 ABD6-129.....119; 123
 ABD6-138.....119; 122; 123
 ABD6-139.....119; 122; 123
 ABD6-201.....120
 ABD6-203.....120; 121; 123
 ABD6-204.....120; 121; 123
 ABD6-205.....120; 121; 123
 ABD6-206B120; 121; 123
 ABD6-207A119; 120; 121;
 122; 123
 ABD6-208.....120; 121; 123
 ABD6-209.....120; 121; 123
 ABD6-210.....120
 ABD6-211.....120; 121; 123
 ABD6-213.....120
 ABD6-218.....120; 121
 ABD6-220.....120; 121
 ABD6-221.....120; 121
 ABD6-222.....120; 121
 ABD6-223.....120; 121
 ABD6-225.....120; 121
 ABD6-228S120; 121; 123
 ABD6-231C120; 121; 123
 ABD6-236.....120
 ABD6-240.....120; 121
 ABD6-241.....120; 121
 ABD6-242.....120; 121
 ABD6-243.....120; 121
 ABDDVT-1000117; 123
 ABDDVT-1001H117; 122; 123
 ABDDVT-1002H117; 122; 123
 ABDDVT-1003A117; 122; 123
 ABDDVT-1004A117; 122; 123
 ABDDVT-1005117; 122; 123
 ABDDVT-1006117; 122; 123
 ABDDVT-1007117; 123
 ABDDVT-12SK122
 ABDDVT-493119
 ABDDVT-802123
 ABDDVT-806119
 ABDDVT-APP122; 123
 ABDDVT-CV-1117; 122; 123
 ABDDVT-SK12VS122
 ABDDVT-SV-1117; 122; 123
 ABDDY-001A124
 ABDDY-002A122; 123; 124
 ABDDY-128B119
 ABDDY-128G119; 122
 ABDDY-1400119; 122

Part # Page#

ABDDY-150124
 ABDDY-158119
 ABDDY-164124
 ABDDY-172124
 ABDDY-2116117
 ABDDY-2416117
 ABDDY-312124
 ABDDY-32VNT124
 ABDDY-7124
 ABDDYN-0513122
 ABDDY-S11124
 ABDDY-S12124
 ABDDY-TPMS-13122
 ABDDY-TPMS-16119; 122
 ABDDY-TPMS-16VS121
 ABDTPMS-72123
 ACC0881219
 ACC10-0100152
 ACC10-0103152
 ACC10-0103D219
 ACC10-0304150; 151; 153; 219
 ACC10-0305150; 151; 153; 219
 ACC10-0306150; 151; 153; 219
 ACC10-0307150; 151; 153; 219
 ACC10-0308150; 151; 153; 219
 ACC10-0309153
 ACC10-0310150; 151; 153; 219
 ACC10-0311150; 151; 153; 219
 ACC10-0312150; 151; 152;
 153; 219
 ACC10-0313150; 151; 152;
 153; 219
 ACC10-0314150
 ACC10-0315150
 ACC10-0317150
 ACC10-0319150
 ACC10-0321151
 ACC10-0322151
 ACC10-0323151
 ACC10-0324151
 ACC10-0326151
 ACC10-0327151; 153
 ACC10-0328151; 152; 153
 ACC10-0329151; 153
 ACC10-0334151; 153
 ACC10-0335153
 ACC10-0336151; 153
 ACC10-0337153
 ACC10-0338153
 ACC10-0339153
 ACC10-0340151; 153
 ACC10-0341151; 153
 ACC10-0342151; 153
 ACC10-0343151; 153
 ACC10-0450152
 ACC10-0455152
 ACC10-3898151; 152; 153
 ACC10-3899151; 152; 153; 219
 ACC20-3045153
 ACC20-3055153
 ACC20-3056153
 ACC20-3100152
 ACC20-3345153
 ACC20-3360153
 ACC20-3900153
 ACC20-3901153

Part # Page#

ACC20-3902153
 ACC20-3903153
 ACC20-3904153
 ACC20-3908152; 153
 ACC20-3909152; 153
 ACC20-3910152; 153
 ACC20-3911152; 153
 ACC20-3913153
 ACC20-3914153
 ACC20-3918152; 153
 ACC20-3919152; 153
 ACC20-3920152; 153
 ACC20-3921152; 153
 ACC20-4000152
 ACC20-4100152
 ACC20-4155153
 ACC2597Y1290152
 KTD72004125
 KTD72502125
 KTD74003125
 KTD74004125
 KTD74503125
 KTD76003125
 KTD76503125
 KTD77601125
 KTD77604126
 KTD77610126
 KTD77621126
 KTD77622126
 KTI00001144
 KTI00002144
 KTI00003187; 216
 KTI00004188; 216
 KTI00005144
 KTI00006145
 KTI00007185
 KTI00009159
 KTI00020179
 KTI00021179
 KTI00022168
 KTI00023132
 KTI00024132
 KTI00026182
 KTI00027180
 KTI00028180
 KTI00033186
 KTI00034187
 KTI00035113; 186; 216
 KTI00037182; 216
 KTI00038183
 KTI00039183
 KTI00040161
 KTI00042161
 KTI00045182
 KTI00047144
 KTI00048145
 KTI00049145
 KTI00050145
 KTI00058160
 KTI00059160
 KTI00067181
 KTI00068181
 KTI00069181
 KTI00070181
 KTI00071165; 215
 KTI00072165; 215

Part # Page#

KTI00074133; 215
 KTI00075165; 215
 KTI00077165
 KTI00078165; 215
 KTI00080180; 215
 KTI00081180; 215
 KTI00082180
 KTI00084165
 KTI00085166
 KTI00086166; 215
 KTI00087183; 215
 KTI00089166; 215
 KTI00091166
 KTI00093167; 215
 KTI00094167; 215
 KTI00095167; 215
 KTI00096132; 215
 KTI00097186; 215
 KTI001221
 KTI004221
 KTI005220
 KTI00811178; 181
 KTI00821178; 181
 KTI00831178; 181
 KTI00841178; 181
 KTI00851178; 181
 KTI00861178; 181
 KTI01611139
 KTI01641177
 KTI01651138
 KTI01661177
 KTI01671177
 KTI01912189
 KTI01920189
 KTI01939189
 KTI02012189
 KTI02020189
 KTI02039189
 KTI02112189
 KTI02127189
 KTI02130189
 KTI02149189
 KTI02212189
 KTI02227189
 KTI02230189
 KTI02249189
 KTI02312189
 KTI02327189
 KTI02330189
 KTI02349189
 KTI02411139
 KTI02421139
 KTI02431139
 KTI02441139
 KTI02451139
 KTI02461139
 KTI02471139
 KTI02481139
 KTI02491139
 KTI02511139
 KTI02611186
 KTI02621186
 KTI02631186
 KTI02641186
 KTI02651186
 KTI02742188



Part # Page#

KTI02743.....188
 KTI02744.....188
 KTI02745.....188
 KTI02751.....188
 KTI02761.....188
 KTI02771.....188
 KTI02781.....188
 KTI02791.....188
 KTI03963.....146
 KTI03964.....146
 KTI03965.....146
 KTI03966.....146
 KTI03967.....146
 KTI03968.....146
 KTI03969.....146
 KTI03970.....146
 KTI03971.....146
 KTI03972.....146
 KTI03973.....146
 KTI03974.....146
 KTI03975.....146
 KTI03976.....146
 KTI03977.....146
 KTI03978.....146
 KTI03979.....146
 KTI03980.....146
 KTI03984.....146
 KTI03985.....146
 KTI04000.....147
 KTI04001.....147
 KTI04002.....147
 KTI04003.....147
 KTI04004.....147
 KTI04005.....147
 KTI04006.....147
 KTI04007.....147
 KTI04008.....146
 KTI04009.....146
 KTI04010.....146
 KTI04011.....147
 KTI04012.....147
 KTI04013.....147
 KTI04014.....147
 KTI04015.....147
 KTI04016.....147
 KTI04017.....147
 KTI04018.....147
 KTI04019.....147
 KTI04020.....147
 KTI04021.....147
 KTI04022.....147
 KTI04023.....146
 KTI04024.....146
 KTI04025.....146
 KTI04026.....146
 KTI04027.....146
 KTI04028.....147
 KTI04029.....147
 KTI04030.....147
 KTI04031.....147
 KTI04032.....147
 KTI04033.....143
 KTI04034.....143
 KTI04035.....143
 KTI04036.....143
 KTI04037.....143

Part # Page#

KTI04038.....143
 KTI04039.....143
 KTI04039R.....143
 KTI04040.....143
 KTI04041.....143
 KTI04042.....143
 KTI04049.....185
 KTI04050.....185
 KTI04051.....185
 KTI04052.....185
 KTI04053.....185
 KTI04054.....185
 KTI04055.....185
 KTI04056.....185
 KTI04057.....182; 183; 184
 KTI04058.....182; 183; 184
 KTI04059.....182; 183; 184
 KTI04060.....183; 184
 KTI04061.....183; 184
 KTI04062.....182; 183; 184
 KTI04063.....182; 183; 184
 KTI04064.....183; 184
 KTI04065.....182; 184
 KTI04066.....183; 184
 KTI04067.....182; 183; 184
 KTI04068.....182; 183; 184
 KTI04069.....182; 183; 184; 187
 KTI04070.....182; 183; 184; 187
 KTI04071.....182; 183; 184; 187
 KTI04072.....182; 184
 KTI04073.....182; 184
 KTI04074.....182; 183; 184
 KTI04075.....182; 183; 184
 KTI04076.....182; 184
 KTI04077.....182; 184
 KTI04078.....183; 184
 KTI04079.....183; 184
 KTI04080.....183; 184
 KTI04081.....183; 184
 KTI04082.....183; 184
 KTI04083.....183; 184
 KTI04084.....183; 184
 KTI04085.....183; 184
 KTI04086.....183; 185
 KTI04087.....183; 185
 KTI04088.....183; 185
 KTI04089.....183; 185
 KTI04090.....183; 185
 KTI04091.....183; 185
 KTI04092.....183; 185
 KTI04093.....183; 185
 KTI04094.....183; 185; 188
 KTI04095.....183; 185
 KTI04096.....183; 185; 188
 KTI04097.....183; 185
 KTI04098.....183; 185; 188
 KTI04099.....183; 185
 KTI04100.....183; 185
 KTI04101.....183; 185
 KTI04102.....183; 185
 KTI04103.....183; 185
 KTI04104.....183; 185
 KTI04105.....183; 185
 KTI04106.....183; 184
 KTI04107.....183; 184
 KTI04108.....183; 184

Part # Page#

KTI04109.....183; 184
 KTI04120.....160
 KTI04121.....160
 KTI04123.....160
 KTI04124.....160
 KTI04125.....160
 KTI04126.....160
 KTI04134.....159
 KTI04135.....159
 KTI04136.....159
 KTI04137.....159
 KTI04138.....159
 KTI04139.....159
 KTI04140.....159
 KTI04141.....160
 KTI04142.....160
 KTI04168.....160
 KTI04181.....160
 KTI04182.....160
 KTI04183.....160
 KTI04184.....160
 KTI04185.....160
 KTI04188.....160
 KTI04189.....160
 KTI04190.....160
 KTI04193.....160
 KTI04195.....160
 KTI04196.....160
 KTI04198.....160
 KTI04199.....178; 179; 180
 KTI04200.....178; 179; 180
 KTI04201.....178; 179; 180
 KTI04202.....178; 179; 180
 KTI04203.....178; 179; 180
 KTI04204.....178; 179; 180
 KTI04205.....178; 179; 180
 KTI04206.....178; 179; 180
 KTI04207.....178; 179; 180
 KTI04208.....178; 179; 180
 KTI04209.....178; 179
 KTI04210.....178; 179
 KTI04211.....178; 179
 KTI04212.....178; 179
 KTI04213.....178; 179
 KTI04214.....178; 179
 KTI04215.....178; 179
 KTI04216.....178; 179
 KTI04220.....179; 182
 KTI04221.....179; 182
 KTI04222.....179; 182
 KTI04223.....179; 182
 KTI04224.....179; 182
 KTI04226.....179; 182
 KTI04227.....179; 182
 KTI04228.....179; 182
 KTI04229.....179; 182
 KTI04230.....179; 182
 KTI04231.....179; 182
 KTI04234.....178; 179; 180
 KTI04235.....178; 179; 180
 KTI04236.....178; 179; 180
 KTI04237.....178; 179; 180
 KTI04238.....178; 179; 180
 KTI04239.....178; 179
 KTI04240.....160; 161
 KTI04241.....160; 161

Part # Page#

KTI04242.....160; 161
 KTI04243.....160; 161
 KTI04245.....160; 161
 KTI04247.....160; 161
 KTI04251.....160; 161
 KTI04252.....160; 161
 KTI04253.....160; 161
 KTI04260.....160; 161
 KTI04261.....160; 161
 KTI04262.....160; 161
 KTI04263.....160; 161
 KTI04264.....160; 161
 KTI04265.....160; 161
 KTI04266.....160; 161
 KTI04270.....178; 181
 KTI04271.....178; 181
 KTI04272.....178; 181
 KTI04273.....178; 181
 KTI04274.....178; 181
 KTI04275.....178; 181
 KTI04276.....178; 181
 KTI04277.....178; 181
 KTI04278.....178; 181
 KTI04279.....178; 181
 KTI04280.....178; 181
 KTI04281.....178; 181
 KTI04282.....178; 181
 KTI04283.....178; 181
 KTI04284.....178; 181
 KTI04285.....178; 181
 KTI04286.....178; 181
 KTI04308.....132; 133
 KTI04309.....132; 133
 KTI04310.....132; 133
 KTI04311.....132; 133
 KTI04312.....132; 133
 KTI04313.....132; 133
 KTI04314.....132; 133
 KTI04315.....132; 133
 KTI04316.....132; 133
 KTI04317.....132; 133
 KTI04318.....132; 133
 KTI04319.....132; 133
 KTI04320.....132; 133
 KTI04458.....165
 KTI04471.....165
 KTI04494.....186
 KTI04497.....182; 184
 KTI04626.....171
 KTI04627.....172
 KTI05100.....171; 173
 KTI05101.....171; 173
 KTI05102.....171; 173
 KTI05103.....171; 173
 KTI05104.....171; 173
 KTI05105.....171; 173
 KTI05106.....171; 173
 KTI05107.....171; 173
 KTI05108.....171; 173
 KTI05109.....171; 175
 KTI05110.....171; 175
 KTI05111.....171; 175
 KTI05112.....171; 175
 KTI05113.....171; 175
 KTI05114.....171; 175
 KTI05115.....171; 175



PART NUMBER INDEX

Part # Page#

KTI05116.....171; 175
 KTI05117.....171; 175
 KTI05118.....171; 174
 KTI05119.....171; 174
 KTI05120.....171; 174
 KTI05124.....173
 KTI05125.....173
 KTI05126.....173
 KTI05127.....173
 KTI05136.....175
 KTI05138.....175
 KTI05141.....175
 KTI05143.....175
 KTI05145.....175
 KTI05149.....175
 KTI05159.....175
 KTI05165.....175
 KTI05167.....175
 KTI05169.....175
 KTI05171.....175
 KTI05177.....174
 KTI05179.....174
 KTI05181.....174
 KTI05186.....171
 KTI05202.....173
 KTI05205.....174
 KTI05206.....174
 KTI05207.....174
 KTI05209.....176
 KTI05211.....176
 KTI05213.....176
 KTI05215.....176
 KTI05217.....176
 KTI05219.....176
 KTI05221.....176
 KTI05225.....174
 KTI05226.....174
 KTI05228.....174
 KTI05233.....176
 KTI05235.....176
 KTI05237.....176
 KTI05243.....176
 KTI05245.....176
 KTI05253.....176
 KTI05255.....176
 KTI05257.....171; 174
 KTI05259.....171; 174
 KTI05370.....174
 KTI05371.....174
 KTI05372.....176
 KTI05373.....176
 KTI05374.....176
 KTI05375.....173
 KTI05376.....173
 KTI05377.....173
 KTI05378.....173
 KTI05379.....173
 KTI05380.....173
 KTI05381.....173
 KTI05382.....173
 KTI05383.....173
 KTI05384.....173
 KTI07740.....113; 187; 215
 KTI0805.....195
 KTI0806.....196
 KTI0807.....197

Part # Page#

KTI0808.....198
 KTI0809.....199
 KTI0810.....200
 KTI0811.....200
 KTI0812.....201
 KTI0813.....202
 KTI0814.....203
 KTI0815.....203
 KTI0816.....204
 KTI0817.....204
 KTI0819.....205
 KTI0820.....205
 KTI0821.....206
 KTI0822.....207
 KTI0831.....207
 KTI0832.....208
 KTI0833.....208
 KTI0834.....209
 KTI0835.....210
 KTI0836.....211
 KTI0837.....211
 KTI0838.....212
 KTI0839.....212
 KTI0840.....214
 KTI0842.....215
 KTI0843.....215
 KTI0844.....216
 KTI0845.....216
 KTI0846.....217
 KTI0847.....217
 KTI0848.....218
 KTI0849.....218
 KTI0850.....199
 KTI0852.....219
 KTI087.....220
 KTI088.....214; 218; 220
 KTI089.....195; 196; 198;
 201; 202; 203;
 209; 210; 211;
 215; 221
 KTI098.....220; 221
 KTI10010.....95
 KTI10210.....95
 KTI10215.....95
 KTI10330.....71
 KTI11001.....28; 199
 KTI11002.....28; 199
 KTI11003.....28; 199
 KTI11004.....28
 KTI11005.....28; 199
 KTI11006.....28; 199
 KTI11007.....28
 KTI11008.....28; 199
 KTI11009.....28; 199
 KTI11010.....28; 199
 KTI11011.....28; 199
 KTI11012.....28; 199
 KTI11018.....28
 KTI11035.....28
 KTI11100.....30
 KTI11110.....30
 KTI11201.....28
 KTI11202.....28
 KTI11203.....28
 KTI11204.....28
 KTI11205.....28

Part # Page#

KTI11206.....28
 KTI11207.....28
 KTI11208.....28
 KTI11209.....28
 KTI11210.....28
 KTI11211.....28; 199
 KTI11215.....28; 199
 KTI11220.....28; 199
 KTI11221.....28; 199
 KTI11223.....28; 199
 KTI11224.....28; 199
 KTI11225.....28; 199
 KTI11226.....28; 199
 KTI11227.....28
 KTI11228.....28
 KTI11229.....28; 199
 KTI11230.....28; 199
 KTI11231.....28
 KTI11310.....30; 199
 KTI11315.....30; 199
 KTI11320.....30; 199
 KTI14219.....30
 KTI14400.....31; 211
 KTI14406.....31; 211
 KTI14408.....31; 211
 KTI14410.....31; 211
 KTI14411.....31; 211
 KTI14412.....31; 211
 KTI14414.....31; 211
 KTI14416.....31; 211
 KTI14500.....31; 211
 KTI14505.....31; 211
 KTI14506.....31; 211
 KTI14507.....31; 211
 KTI14508.....31; 211
 KTI14509.....31; 211
 KTI14510.....31; 211
 KTI14511.....31; 211
 KTI16000.....29
 KTI16001.....29; 199
 KTI16002.....29; 199
 KTI16113.....29; 199
 KTI16121.....29; 199
 KTI16124.....29; 199
 KTI16129.....29; 199
 KTI16136.....29; 199
 KTI16201.....29; 199
 KTI16203.....29; 199
 KTI16204.....29; 199
 KTI16206.....29; 199
 KTI16208.....29; 199
 KTI18000.....28; 49; 199
 KTI18007.....49
 KTI18008.....26
 KTI18009.....28; 199
 KTI18012.....26
 KTI18013.....49
 KTI18014.....49
 KTI18702.....47
 KTI18703.....47
 KTI18801.....47
 KTI18802.....47
 KTI18810.....116
 KTI18820.....116
 KTI18900.....28
 KTI18901.....28

Part # Page#

KTI18902.....28
 KTI18903.....28
 KTI18904.....28
 KTI18905.....28
 KTI18906.....28
 KTI18907.....28
 KTI18910.....28
 KTI18915.....28
 KTI18920.....28
 KTI18925.....28
 KTI18992.....49
 KTI19000.....29; 30; 199; 222
 KTI19113.....29; 199
 KTI19121.....29; 199
 KTI19124.....29; 199
 KTI19138.....30
 KTI19201.....29; 199
 KTI19203.....29; 199
 KTI19204.....29; 199
 KTI19206.....29; 199
 KTI19208.....29; 199
 KTI19209.....32
 KTI19212.....32
 KTI19218.....32
 KTI19224.....32
 KTI19240.....32
 KTI19700.....29
 KTI19701.....29
 KTI19703.....29
 KTI19704.....29
 KTI19706.....29
 KTI19708.....29
 KTI19713.....29
 KTI19721.....29
 KTI19724.....29
 KTI19800.....29
 KTI19801.....29
 KTI19803.....29
 KTI19804.....29
 KTI19806.....29
 KTI19808.....29
 KTI19813.....29
 KTI19821.....29
 KTI19824.....29
 KTI19900.....29
 KTI19901.....29
 KTI19903.....29
 KTI19904.....29
 KTI19906.....29
 KTI19908.....29
 KTI19913.....29
 KTI19921.....29
 KTI19924.....29
 KTI20045.....6
 KTI20210.....6; 10
 KTI20212.....6; 10
 KTI20214.....6; 10
 KTI20216.....6; 10
 KTI20218.....6; 10
 KTI20220.....6; 10
 KTI20222.....6; 10
 KTI20224.....6; 10
 KTI20226.....6; 10
 KTI20228.....6; 10
 KTI20310.....6; 10
 KTI20311.....6; 10



Part # Page#

KTI20312.....6; 10
 KTI20313.....6; 10
 KTI20314.....6; 10
 KTI20315.....6; 10
 KTI20316.....6; 10
 KTI20317.....6; 10
 KTI20318.....6; 10
 KTI20319.....6; 10
 KTI20412.....6; 10
 KTI20414.....6; 10
 KTI20416.....6; 10
 KTI20418.....6; 10
 KTI20420.....6; 10
 KTI20422.....6; 10
 KTI20424.....6; 10
 KTI20426.....6; 10
 KTI20428.....6; 10
 KTI20707.....6; 10
 KTI20708.....6; 10
 KTI20709.....6; 10
 KTI20710.....6; 10
 KTI20711.....6; 10
 KTI20712.....6; 10
 KTI20713.....6; 10
 KTI20714.....6; 10
 KTI20715.....6; 10
 KTI20716.....6; 10
 KTI20717.....6; 10
 KTI20718.....6; 10
 KTI20719.....6; 10
 KTI21000.....5; 195
 KTI21002.....5; 20; 195; 209
 KTI21004.....5; 20; 195; 209
 KTI21006.....5; 20; 195; 209
 KTI21010.....20; 195
 KTI21014.....20; 195
 KTI21040.....20
 KTI21043.....20; 195
 KTI21044.....5; 30; 195; 222
 KTI21046.....20; 195
 KTI21048.....20; 195
 KTI21050.....5; 20; 195; 209
 KTI21055.....20; 196; 209
 KTI21060.....5; 20; 195; 209
 KTI21061.....20
 KTI21070.....20
 KTI21080.....20; 195
 KTI21091.....5; 20; 195; 209
 KTI21092.....5; 20; 195; 209
 KTI21092RK.....20
 KTI21095.....20; 195
 KTI21100.....6
 KTI21106.....5; 6; 195; 209
 KTI21107.....5; 6; 195; 209
 KTI21108.....5; 6; 195; 209
 KTI21109.....5; 6; 195; 209
 KTI21110.....5; 6; 195; 209
 KTI21111.....5; 195; 209
 KTI21112.....5; 6; 195; 209
 KTI21114.....5; 6; 195; 209
 KTI21116.....5; 6; 195; 209
 KTI21118.....5; 195; 209
 KTI21200.....6
 KTI21206.....5; 195; 209
 KTI21207.....5; 6; 195; 209
 KTI21208.....5; 6; 195; 209

Part # Page#

KTI21209.....5; 6; 195; 209
 KTI21210.....5; 6; 195; 209
 KTI21211.....5; 6; 195; 209
 KTI21212.....5; 6; 195; 209
 KTI21214.....5; 6; 195; 209
 KTI21216.....5; 6; 195; 209
 KTI21218.....5; 195; 209
 KTI21500.....26; 200
 KTI21510.....26
 KTI21515.....26
 KTI21520.....26
 KTI21525.....26
 KTI21527.....26
 KTI21530.....26
 KTI21540.....26
 KTI21545.....26
 KTI21550.....26
 KTI21555.....26
 KTI21610.....25; 26; 200
 KTI21615.....25; 26; 200
 KTI21620.....25; 26; 200
 KTI21625.....25; 26; 200
 KTI21627.....25; 26; 200
 KTI21630.....25; 26; 200
 KTI21810.....26; 200
 KTI21815.....26; 200
 KTI21820.....26; 200
 KTI21825.....26; 200
 KTI21827.....26; 200
 KTI21830.....26; 200
 KTI22000.....7; 196
 KTI22001.....20
 KTI22002.....7; 21; 196
 KTI22003.....6; 7; 21; 196; 209
 KTI22005.....21; 196
 KTI22006.....6; 7; 8; 21; 196; 209
 KTI22008.....21; 196; 209
 KTI22010.....21; 196
 KTI22012.....8; 21; 196
 KTI22018.....21; 196
 KTI22023.....8
 KTI22024.....21; 196
 KTI22041.....21
 KTI22043.....21; 196
 KTI22046.....21; 196
 KTI22047.....7; 30; 196; 222
 KTI22048.....21; 196
 KTI22050.....22; 196; 209
 KTI22055.....21; 196; 209
 KTI22060.....21; 196; 209
 KTI22070.....21
 KTI22071.....8; 21; 196
 KTI22071A.....21
 KTI22075.....22; 198; 209; 218
 KTI22080.....8; 21; 196
 KTI22091.....7; 8; 21; 196; 209
 KTI22092.....6; 7; 21; 196; 209
 KTI22092RK.....21
 KTI22093.....21; 196
 KTI22095.....21; 196
 KTI22100.....8
 KTI22108.....7; 10
 KTI22110.....7; 8; 10; 197; 209
 KTI22112.....7; 8; 10; 197; 209
 KTI22114.....7; 8; 10; 197; 209

Part # Page#

KTI22116.....7; 8; 10; 197; 209
 KTI22118.....7; 8; 10; 197; 209
 KTI22120.....7; 8; 10; 197; 209
 KTI22122.....7; 8; 10; 197; 209
 KTI22124.....7; 8; 10; 197; 209
 KTI22126.....7; 8; 10; 197; 209
 KTI22128.....7; 8; 10; 197; 209
 KTI22130.....10; 197; 209
 KTI22132.....10; 197; 209
 KTI22133.....9; 177; 196
 KTI22201.....9
 KTI22208.....10
 KTI22210.....10; 197
 KTI22212.....7; 9; 10; 197; 209
 KTI22214.....7; 9; 10; 197; 209
 KTI22216.....7; 9; 10; 197; 209
 KTI22218.....7; 9; 10; 197; 209
 KTI22219.....7; 196
 KTI22220.....7; 9; 10; 197; 209
 KTI22221.....9; 177; 196; 210
 KTI22222.....7; 9; 10; 197; 209
 KTI22224.....7; 9; 10; 197; 209
 KTI22226.....7; 9; 10; 197; 209
 KTI22227.....9; 177; 196; 210
 KTI22228.....7; 9; 10; 197; 209
 KTI22230.....10; 197; 209
 KTI22232.....10; 197; 209
 KTI22300.....39
 KTI22312.....39
 KTI22314.....39
 KTI22316.....39
 KTI22318.....39
 KTI22320.....39
 KTI22322.....39
 KTI22324.....39
 KTI22328.....39
 KTI22401.....9
 KTI22408.....9; 10; 197
 KTI22410.....9; 10; 197
 KTI22412.....7; 9; 10; 197
 KTI22414.....7; 9; 10; 197
 KTI22416.....7; 8; 9; 10; 197
 KTI22418.....7; 8; 9; 10; 197
 KTI22420.....7; 8; 9; 10; 197
 KTI22422.....7; 8; 9; 10; 197
 KTI22424.....7; 8; 9; 10; 197
 KTI22426.....7; 8; 9; 10; 197
 KTI22428.....7; 9; 10; 197
 KTI22430.....9; 10; 197
 KTI22432.....9; 10; 197
 KTI22500.....8; 21; 196; 209
 KTI22501.....8
 KTI22508.....7; 8; 10; 197
 KTI22510.....7; 8; 10; 197
 KTI22512.....7; 8; 10; 197
 KTI22514.....7; 8; 10; 197
 KTI22516.....7; 8; 10; 197
 KTI22518.....7; 8; 10; 197
 KTI22520.....7; 8; 10; 197
 KTI22521.....9; 177; 196
 KTI22522.....7; 8; 10; 197
 KTI22524.....7; 8; 10; 197
 KTI22526.....7; 8; 10; 197
 KTI22527.....9; 177; 196
 KTI22528.....7; 8; 10; 197
 KTI22530.....8; 10; 197

Part # Page#

KTI22532.....8; 10; 197
 KTI22547.....7
 KTI22600.....25
 KTI22601.....25; 200
 KTI22640.....25; 26; 200
 KTI22645.....25; 26; 200
 KTI22647.....25; 26; 200
 KTI22650.....25; 26; 200
 KTI22655.....25; 26; 200
 KTI22660.....25; 26; 200
 KTI22670.....26; 200
 KTI22671.....25; 200
 KTI22675.....25; 200
 KTI22676.....25; 200
 KTI22677.....25; 200
 KTI22678.....25; 200
 KTI22680.....25; 200
 KTI22682.....25; 200
 KTI22684.....25; 200
 KTI22686.....25; 200
 KTI22688.....25; 200
 KTI22689.....25; 200
 KTI22700.....9
 KTI22710.....9
 KTI22712.....9
 KTI22714.....9
 KTI22716.....8; 9
 KTI22718.....8; 9
 KTI22720.....9
 KTI22722.....9
 KTI22724.....9
 KTI22800.....26; 200
 KTI22801.....26; 200
 KTI22802.....25; 142
 KTI22840.....25; 26; 142; 200
 KTI22845.....25; 26; 142; 200
 KTI22847.....26; 200
 KTI22850.....25; 26; 142; 200
 KTI22855.....26; 200
 KTI22860.....26; 200
 KTI22870.....25; 200
 KTI22874.....25; 200
 KTI22875.....25; 200
 KTI22876.....25; 200
 KTI22877.....25; 200
 KTI22878.....25; 200
 KTI22880.....25; 200
 KTI22882.....25; 200
 KTI22884.....25; 200
 KTI22886.....25; 200
 KTI22888.....25; 200
 KTI22902.....24; 142
 KTI22904.....24; 200
 KTI22905.....24; 200
 KTI22906.....24; 200
 KTI22907.....24; 200
 KTI22908.....24; 142; 200
 KTI22910.....24; 142; 200
 KTI22912.....24; 142; 200
 KTI22914.....49
 KTI22970.....24; 200
 KTI23000.....13
 KTI23003.....22; 198; 209
 KTI23005.....13; 22; 198; 209
 KTI23010.....22; 198; 209
 KTI23015.....22; 198



PART NUMBER INDEX

Part # Page#

KPI23020.....22; 198
KPI23070.....22; 198
KPI23080.....13; 22; 198
KPI23081.....22; 198
KPI23082.....22; 198
KPI23083.....22; 198
KPI23091.....13; 22; 198; 209
KPI23092.....22; 198; 209
KPI23092RK.....22
KPI23095.....22; 198
KPI23110.....13
KPI23112.....14; 198
KPI23114.....13; 14; 198
KPI23116.....13; 14; 198; 209
KPI23118.....13; 14; 198; 209
KPI23120.....13; 14; 198; 209
KPI23122.....13; 14; 198; 209
KPI23124.....13; 14; 198; 209
KPI23126.....13; 14; 198; 209
KPI23128.....13; 14; 198; 209
KPI23130.....13; 14; 198; 209
KPI23132.....13; 14; 198; 209
KPI23134.....13; 14; 198; 209
KPI23136.....13; 14; 198; 209
KPI23140.....13; 14; 198; 209
KPI23142.....14; 198
KPI23144.....14; 198
KPI23146.....14; 198
KPI23148.....14; 198
KPI23200.....13
KPI23214.....14; 198
KPI23216.....13; 14; 198; 209
KPI23218.....13; 14; 198; 209
KPI23220.....13; 14; 198; 209
KPI23222.....13; 14; 198; 209
KPI23224.....13; 14; 198; 209
KPI23226.....13; 14; 198; 209
KPI23228.....13; 14; 198; 209
KPI23230.....13; 14; 198; 209
KPI23232.....14; 198; 209
KPI23234.....14; 198; 209
KPI23236.....14; 198; 209
KPI23240.....14; 198; 209
KPI23242.....14; 198
KPI23244.....14; 198
KPI23246.....14; 198
KPI23248.....22; 198
KPI23308.....49
KPI23348.....14
KPI23500.....22; 198; 209
KPI23512.....14
KPI23516.....14
KPI23800.....13
KPI23808.....13; 198
KPI23810.....13; 198
KPI23812.....13; 198
KPI23814.....13; 198
KPI23900.....13
KPI23906.....13; 198
KPI23908.....13; 198
KPI23910.....13; 198
KPI23912.....13; 198
KPI24004.....17; 23; 218
KPI24008.....17; 23; 218
KPI24016.....23; 218
KPI24050.....23; 198; 218

Part # Page#

KPI24070.....17; 23; 218
KPI24070B.....23
KPI24080.....23; 218
KPI24085.....24; 218
KPI24090.....17; 22
KPI24090RK.....22
KPI24092.....22; 218
KPI24105.....17
KPI24121.....17
KPI24124.....17; 218
KPI24128.....17; 218
KPI24130.....17; 218
KPI24132.....17; 218
KPI24134.....17; 218
KPI24136.....17; 218
KPI24138.....17; 218
KPI24140.....17; 218
KPI24142.....17; 218
KPI24144.....17; 218
KPI24146.....17; 218
KPI24148.....17; 218
KPI24152.....17; 218
KPI24156.....17; 218
KPI24160.....17; 218
KPI24164.....17; 218
KPI24166.....17; 218
KPI24168.....17; 218
KPI24170.....17; 218
KPI24172.....17; 218
KPI24173.....17
KPI24176.....17; 218
KPI24500.....23; 218
KPI26000.....5; 195
KPI26100.....6
KPI26104.....5; 195
KPI26105.....5; 195; 210
KPI26106.....5; 6; 195; 210
KPI26107.....5; 6; 195; 210
KPI26108.....5; 6; 195; 210
KPI26109.....5; 6; 195; 210
KPI26110.....5; 6; 195; 210
KPI26111.....5; 6; 195; 210
KPI26112.....5; 6; 210
KPI26113.....5; 6; 210
KPI26114.....5; 195; 210
KPI26115.....5; 195; 210
KPI26155.....5; 195; 210
KPI26200.....6
KPI26206.....5; 6; 195; 210
KPI26207.....5; 6; 195; 210
KPI26208.....5; 6; 195; 210
KPI26209.....5; 6; 195; 210
KPI26210.....5; 6; 195; 210
KPI26211.....5; 6; 195; 210
KPI26212.....5; 6; 195; 210
KPI26213.....5; 6; 195; 210
KPI26214.....5; 195; 210
KPI26215.....5; 195; 210
KPI26255.....5; 195; 210
KPI27000.....7; 196
KPI27101.....8
KPI27106.....7; 10
KPI27107.....7; 8; 10; 197
KPI27108.....7; 8; 10; 197; 210
KPI27109.....7; 8; 10; 197; 210
KPI27110.....7; 8; 10; 197; 210

Part # Page#

KPI27111.....7; 8; 10; 197; 210
KPI27112.....7; 8; 10; 197; 210
KPI27113.....7; 8; 10; 197; 210
KPI27114.....7; 8; 10; 197; 210
KPI27115.....7; 8; 10; 197; 210
KPI27116.....7; 8; 10; 197; 210
KPI27117.....7; 8; 10; 197; 210
KPI27118.....7; 8; 10; 197; 210
KPI27119.....7; 8; 10; 197; 210
KPI27120.....7; 10; 197
KPI27121.....7; 10; 197
KPI27122.....10; 197
KPI27123.....10; 197
KPI27124.....10; 197
KPI27125.....10; 197
KPI27126.....10; 197
KPI27201.....9
KPI27206.....10
KPI27207.....10; 197
KPI27208.....10; 197
KPI27209.....10; 197
KPI27210.....7; 9; 10; 197; 210
KPI27211.....7; 9; 10; 197; 210
KPI27212.....7; 9; 10; 197; 210
KPI27213.....7; 9; 10; 197; 210
KPI27214.....7; 9; 10; 197; 210
KPI27215.....7; 9; 10; 197; 210
KPI27216.....7; 9; 10; 197; 210
KPI27217.....7; 9; 10; 197; 210
KPI27218.....7; 9; 10; 197; 210
KPI27219.....7; 10; 197; 210
KPI27220.....10; 197
KPI27221.....10; 197
KPI27222.....10; 197
KPI27223.....10; 197
KPI27224.....10; 197
KPI27225.....10; 197
KPI27226.....10; 197
KPI27300.....39
KPI27310.....39
KPI27311.....39
KPI27312.....39
KPI27313.....39
KPI27314.....39
KPI27315.....39
KPI27316.....39
KPI27317.....39
KPI27318.....39
KPI27319.....39
KPI27401.....9
KPI27407.....9; 10; 197
KPI27408.....9; 10; 197
KPI27409.....9; 10; 197
KPI27410.....7; 9; 10; 197
KPI27411.....7; 9; 10; 197
KPI27412.....7; 9; 10; 197
KPI27413.....7; 9; 10; 197
KPI27414.....7; 9; 10; 197
KPI27415.....7; 9; 10; 197
KPI27416.....7; 9; 10; 197
KPI27417.....7; 9; 10; 197
KPI27418.....7; 9; 10; 197
KPI27419.....7; 9; 10; 197
KPI27420.....9; 10; 197
KPI27421.....9; 10; 197
KPI27501.....8

Part # Page#

KPI27506.....7; 10
KPI27507.....7; 8; 10; 197; 210
KPI27508.....7; 8; 10; 197
KPI27509.....7; 8; 10; 197
KPI27510.....7; 8; 10; 197
KPI27511.....7; 8; 10; 197
KPI27512.....7; 8; 10; 197
KPI27513.....7; 8; 10; 197
KPI27514.....7; 8; 10; 197
KPI27515.....7; 8; 10; 197
KPI27516.....7; 8; 10; 197
KPI27517.....7; 8; 10; 197
KPI27518.....7; 8; 10; 197
KPI27519.....7; 8; 10; 197
KPI27520.....8; 10; 197
KPI27521.....8; 10; 197
KPI27902.....24; 142
KPI27903.....24; 200
KPI27904.....24; 200
KPI27905.....24; 200
KPI27906.....24; 200
KPI27907.....24; 142; 200
KPI27908.....24; 142; 200
KPI27910.....24; 142; 200
KPI27955.....24; 200
KPI27970.....24; 200
KPI28000.....13
KPI28100.....13
KPI28110.....14; 198; 210
KPI28111.....14; 198; 210
KPI28112.....14; 198; 210
KPI28113.....14; 198; 210
KPI28114.....14; 198; 210
KPI28115.....13; 14; 198; 210
KPI28116.....13; 14; 198; 210
KPI28117.....13; 14; 198; 210
KPI28118.....13; 14; 198; 210
KPI28119.....13; 14; 198; 210
KPI28120.....13; 14; 198; 210
KPI28121.....13; 14; 198; 210
KPI28122.....13; 14; 198
KPI28123.....13; 14; 198
KPI28124.....13; 14; 198
KPI28125.....13; 14; 198
KPI28126.....13; 14; 198
KPI28127.....13; 14; 198
KPI28128.....13; 14; 198
KPI28200.....13
KPI28210.....14; 198; 210
KPI28211.....14; 198; 210
KPI28212.....14; 198; 210
KPI28213.....14; 198; 210
KPI28214.....14; 198; 210
KPI28215.....13; 14; 198; 210
KPI28216.....13; 14; 198; 210
KPI28217.....13; 14; 198; 210
KPI28218.....13; 14; 198; 210
KPI28219.....13; 14; 198; 210
KPI28220.....13; 14; 198; 210
KPI28221.....13; 14; 198; 210
KPI28222.....13; 14; 198
KPI28223.....13; 14; 198
KPI28224.....13; 14; 198
KPI28225.....14; 198
KPI28226.....14; 198
KPI28227.....14; 198



Part # Page#

KTI28228.....14; 198
 KTI31420.....12
 KTI32003.....11; 23
 KTI32012.....23; 212
 KTI32013.....11
 KTI32016.....23; 212
 KTI32100.....11
 KTI32110.....11; 12; 212
 KTI32112.....11; 12; 212
 KTI32114.....11; 12; 212
 KTI32116.....11; 12; 212
 KTI32118.....11; 12; 212
 KTI32120.....11; 12; 212
 KTI32122.....11; 12; 212
 KTI32124.....11; 12; 212
 KTI32126.....11; 12; 212
 KTI32128.....11; 12; 212
 KTI32200.....11
 KTI32210.....11; 12; 212
 KTI32212.....11; 12; 212
 KTI32214.....11; 12; 212
 KTI32216.....11; 12; 212
 KTI32218.....11; 12; 212
 KTI32220.....11; 12; 212
 KTI32222.....11; 12; 212
 KTI32224.....11; 12; 212
 KTI32226.....11; 12; 212
 KTI32228.....11; 12; 212
 KTI32229.....9; 177
 KTI32400.....12
 KTI32414.....12
 KTI32416.....12
 KTI32418.....12
 KTI32420.....12
 KTI32422.....12
 KTI32424.....12
 KTI32500.....12
 KTI32514.....12
 KTI32516.....12
 KTI32518.....12
 KTI32520.....12
 KTI32522.....12
 KTI32524.....12
 KTI33003.....23; 212
 KTI33006.....23; 212
 KTI33012.....23; 212
 KTI33016.....23; 212
 KTI33024.....23; 212
 KTI33041.....23; 212
 KTI33050.....16; 212
 KTI33100.....14
 KTI33101.....14
 KTI33104.....14
 KTI33112.....14; 16; 213
 KTI33114.....14; 16; 213
 KTI33116.....14; 16; 213
 KTI33118.....14; 16; 213
 KTI33120.....14; 16; 213
 KTI33122.....14; 16; 213
 KTI33124.....14; 16; 213
 KTI33126.....14; 16; 213
 KTI33128.....14; 16; 213
 KTI33130.....14; 16; 213
 KTI33132.....14; 16; 213
 KTI33134.....14; 16; 213
 KTI33136.....14; 16; 213

Part # Page#

KTI33138.....14; 16; 213
 KTI33140.....14; 16; 213
 KTI33142.....14; 16; 213
 KTI33144.....14; 16; 213
 KTI33146.....14; 16; 213
 KTI33148.....14; 16; 213
 KTI33200.....15
 KTI33202.....15
 KTI33204.....15
 KTI33212.....15; 16; 213
 KTI33214.....15; 16; 213
 KTI33216.....15; 16; 213
 KTI33218.....15; 16; 213
 KTI33220.....15; 16; 213
 KTI33222.....15; 16; 213
 KTI33224.....15; 16; 213
 KTI33226.....15; 16; 213
 KTI33228.....15; 16; 213
 KTI33230.....15; 16; 213
 KTI33232.....15; 16; 213
 KTI33234.....15; 16; 213
 KTI33236.....15; 16; 213
 KTI33238.....15; 16; 213
 KTI33240.....15; 16; 213
 KTI33242.....15; 16; 213
 KTI33244.....15; 16; 213
 KTI33246.....15; 16; 213
 KTI33248.....15; 16; 213
 KTI33300.....150
 KTI33317.....150; 219
 KTI33319.....150; 219
 KTI33321.....150; 219
 KTI33326.....150; 219
 KTI33328.....150; 219
 KTI33332.....150; 219
 KTI33334.....150; 219
 KTI33350.....150
 KTI33351.....150; 219
 KTI33352.....150; 219
 KTI33353.....150; 219
 KTI33354.....150; 219
 KTI33355.....150; 219
 KTI33356.....150; 219
 KTI33357.....150; 219
 KTI33500.....16
 KTI33516.....16
 KTI33518.....16
 KTI33520.....16
 KTI33522.....16
 KTI33524.....16
 KTI33526.....16
 KTI33528.....16
 KTI3379A.....65
 KTI34016.....24; 213
 KTI34026.....149; 214
 KTI34027.....149; 214
 KTI34032.....24; 214
 KTI34050.....24; 214
 KTI34100.....18
 KTI34101.....18
 KTI34132.....18; 19; 214
 KTI34134.....18; 19; 214
 KTI34136.....18; 19; 214
 KTI34140.....18; 19; 214
 KTI34142.....18; 19; 214
 KTI34144.....18; 19; 214

Part # Page#

KTI34146.....18; 19; 214
 KTI34148.....18; 19; 214
 KTI34150.....18; 19; 214
 KTI34152.....18; 19; 214
 KTI34154.....18; 19; 214
 KTI34156.....18; 19; 214
 KTI34158.....18; 19; 214
 KTI34160.....18; 19; 214
 KTI34162.....18; 19; 214
 KTI34164.....18; 19; 214
 KTI34166.....18; 19; 214
 KTI34168.....18; 19; 214
 KTI34172.....18; 19; 214
 KTI34176.....18; 19; 214
 KTI34200.....18
 KTI34201.....18
 KTI34232.....18; 19; 214
 KTI34234.....18; 19; 214
 KTI34236.....18; 19; 214
 KTI34240.....18; 19; 214
 KTI34242.....18; 19; 214
 KTI34244.....18; 19; 214
 KTI34246.....18; 19; 214
 KTI34248.....18; 19; 214
 KTI34250.....18; 19; 214
 KTI34252.....18; 19; 214
 KTI34254.....18; 19; 214
 KTI34256.....18; 19; 214
 KTI34258.....18; 19; 214
 KTI34260.....18; 19; 214
 KTI34262.....18; 19; 214
 KTI34264.....18; 19; 214
 KTI35001.....19
 KTI35002.....19
 KTI35003.....19
 KTI35004.....19
 KTI35005.....149; 218
 KTI35007.....19; 24; 218
 KTI35013.....19; 24; 218
 KTI35024.....24; 214; 218
 KTI35026.....149; 214; 218
 KTI35027.....149; 214; 218
 KTI35028.....149; 218
 KTI35100.....19
 KTI35113.....81
 KTI35124.....19; 218
 KTI35126.....19; 218
 KTI35128.....19; 218
 KTI35130.....19; 218
 KTI35132.....19; 218
 KTI35134.....19; 218
 KTI35136.....19; 218
 KTI35138.....19; 218
 KTI35140.....19; 218
 KTI35142.....19; 218
 KTI35146.....19; 218
 KTI35148.....19; 218
 KTI35152.....19; 218
 KTI35154.....19; 218
 KTI35158.....19; 218
 KTI35160.....19; 218
 KTI35164.....19; 218
 KTI35166.....19; 218
 KTI35172.....19; 218
 KTI35178.....19; 218
 KTI35184.....19; 218

Part # Page#

KTI35196.....19; 218
 KTI35233.....149; 214; 218
 KTI35234.....19; 218
 KTI35235.....149; 218
 KTI35236.....19; 218
 KTI35238.....149; 218
 KTI35240.....19; 218
 KTI35241.....149; 218
 KTI35242.....19; 218
 KTI37042.....11
 KTI37100.....11
 KTI37108.....11; 12; 213
 KTI37109.....11; 12; 213
 KTI37110.....11; 12; 213
 KTI37111.....11; 12; 213
 KTI37112.....11; 12; 213
 KTI37113.....11; 12; 213
 KTI37114.....11; 12; 213
 KTI37115.....11; 12; 213
 KTI37116.....11; 12; 213
 KTI37117.....11; 12; 213
 KTI37118.....11; 12; 213
 KTI37119.....11; 12; 213
 KTI37200.....11
 KTI37208.....11; 12; 213
 KTI37209.....11; 12; 213
 KTI37210.....11; 12; 213
 KTI37211.....11; 12; 213
 KTI37212.....11; 12; 213
 KTI37213.....11; 12; 213
 KTI37214.....11; 12; 213
 KTI37215.....11; 12; 213
 KTI37216.....11; 12; 213
 KTI37217.....11; 12; 213
 KTI37218.....11; 12; 213
 KTI37219.....11; 12; 213
 KTI37400.....12
 KTI37410.....12
 KTI37411.....12
 KTI37412.....12
 KTI37413.....12
 KTI37414.....12
 KTI37415.....12
 KTI37416.....12
 KTI37417.....12
 KTI37418.....12
 KTI37419.....12
 KTI37500.....12
 KTI37510.....12
 KTI37511.....12
 KTI37512.....12
 KTI37513.....12
 KTI37514.....12
 KTI37515.....12
 KTI38050.....16; 213
 KTI38100.....15
 KTI38101.....15
 KTI38110.....15; 16; 213
 KTI38111.....15; 16; 213
 KTI38112.....15; 16; 213
 KTI38113.....15; 16; 213
 KTI38114.....15; 16; 213
 KTI38115.....15; 16; 213
 KTI38116.....15; 16; 213
 KTI38117.....15; 16; 213
 KTI38118.....15; 16; 213



PART NUMBER INDEX

Part # Page#

KTI38119.....15; 16; 213
 KTI38120.....15; 16; 213
 KTI38121.....15; 16; 213
 KTI38122.....15; 16; 213
 KTI38123.....15; 16; 213
 KTI38124.....15; 16; 213
 KTI38125.....15; 16; 213
 KTI38126.....15; 16; 213
 KTI38127.....15; 16; 213
 KTI38128.....15; 16; 213
 KTI38129.....15; 16; 213
 KTI38130.....15; 16; 213
 KTI38132.....15; 16; 213
 KTI38133.....15; 16; 213
 KTI38134.....15; 16; 213
 KTI38135.....15; 16; 213
 KTI38136.....15; 16; 213
 KTI38200.....15
 KTI38201.....15
 KTI38202.....15
 KTI38210.....15; 16; 213
 KTI38211.....15; 16; 213
 KTI38212.....15; 16; 213
 KTI38213.....15; 16; 213
 KTI38214.....15; 16; 213
 KTI38215.....15; 16; 213
 KTI38216.....15; 16; 213
 KTI38217.....15; 16; 213
 KTI38218.....15; 16; 213
 KTI38219.....15; 16; 213
 KTI38220.....15; 16; 213
 KTI38221.....15; 16; 213
 KTI38222.....15; 16; 213
 KTI38223.....15; 16; 213
 KTI38224.....15; 16; 213
 KTI38225.....15; 16; 213
 KTI38226.....15; 16; 213
 KTI38227.....15; 16; 213
 KTI38228.....15; 16; 213
 KTI38229.....15; 16; 213
 KTI38230.....15; 16; 213
 KTI38232.....15; 16; 213
 KTI38233.....15; 16; 213
 KTI38234.....15; 16; 213
 KTI38235.....15; 16; 213
 KTI38236.....15; 16; 213
 KTI38500.....16
 KTI38513.....16
 KTI38514.....16
 KTI38515.....16
 KTI38517.....16
 KTI38518.....16
 KTI38519.....16
 KTI39001.....18
 KTI39003.....18
 KTI39100.....18
 KTI39117.....18; 19
 KTI39119.....18; 19
 KTI39120.....18; 19
 KTI39122.....18; 19
 KTI39124.....18; 19
 KTI39127.....18; 19
 KTI39130.....18; 19
 KTI39131.....18; 19
 KTI39132.....18; 19
 KTI39134.....18; 19

Part # Page#

KTI39135.....18; 19
 KTI39136.....18; 19
 KTI39138.....18; 19
 KTI39140.....18; 19
 KTI39146.....18; 19
 KTI39233.....149
 KTI41004.....37
 KTI41006.....37
 KTI41011.....36
 KTI41013.....36
 KTI41014.....37
 KTI41016.....37
 KTI41108.....38; 210
 KTI41110.....38; 201; 210
 KTI41112.....38; 201; 210
 KTI41114.....38; 201; 210
 KTI41116.....38; 201; 210
 KTI41118.....38; 201; 210
 KTI41120.....38; 201; 210
 KTI41122.....38; 201; 210
 KTI41124.....38; 201; 210
 KTI41126.....38; 201; 210
 KTI41128.....38; 201; 210
 KTI41130.....38; 201; 210
 KTI41132.....38; 201; 210
 KTI41134.....38; 201; 210
 KTI41136.....38; 201; 210
 KTI41140.....38; 201
 KTI41142.....37; 201
 KTI41144.....37; 203
 KTI41146.....37; 203
 KTI41148.....37; 203
 KTI41152.....37; 203
 KTI41156.....37; 203
 KTI41158.....37
 KTI41160.....37; 203
 KTI41164.....37; 203
 KTI41168.....37; 203
 KTI41172.....37; 203
 KTI41176.....37; 203
 KTI41180.....37; 203
 KTI41200.....35
 KTI41212.....38; 201
 KTI41214.....38; 201
 KTI41216.....38; 201
 KTI41218.....38; 201
 KTI41220.....38; 201
 KTI41222.....38; 201
 KTI41224.....38; 201
 KTI41300.....30; 34; 222
 KTI41301.....35
 KTI41304.....34
 KTI41305.....35
 KTI41308.....38; 201
 KTI41310.....38; 201
 KTI41311.....38; 201
 KTI41312.....38; 201
 KTI41314.....38; 201
 KTI41316.....38; 201
 KTI41318.....38; 201
 KTI41320.....38; 201
 KTI41322.....38; 201
 KTI41324.....38; 201
 KTI41326.....38; 201
 KTI41328.....38; 201
 KTI41330.....38; 201

Part # Page#

KTI41332.....38; 201
 KTI41334.....38; 201
 KTI41336.....38; 201
 KTI41338.....38
 KTI41340.....38; 201
 KTI41342.....38; 201
 KTI41344.....38; 201
 KTI41346.....38; 201
 KTI41348.....38; 201
 KTI41350.....38
 KTI41352.....38
 KTI41372.....38
 KTI41412.....38; 201
 KTI41414.....38; 201
 KTI41416.....38; 201
 KTI41418.....38; 201
 KTI41420.....38; 201
 KTI41422.....38; 201
 KTI41424.....38; 201
 KTI41513.....36
 KTI41607.....35; 202
 KTI41608.....35; 202; 210
 KTI41609.....35; 202; 210
 KTI41610.....35; 202; 210
 KTI41611.....35; 202; 210
 KTI41612.....35; 202; 210
 KTI41613.....35; 202; 210
 KTI41614.....35; 202; 210
 KTI41615.....35; 202; 210
 KTI41616.....35; 202; 210
 KTI41617.....35; 202; 210
 KTI41618.....35; 202; 210
 KTI41619.....35; 202; 210
 KTI41700.....36
 KTI41708.....38; 202
 KTI41710.....38; 202
 KTI41712.....38; 202
 KTI41713.....38; 202
 KTI41714.....38; 202
 KTI41715.....38; 202
 KTI41717.....38; 202
 KTI41718.....38; 202
 KTI41800.....30; 35; 222
 KTI41801.....36
 KTI41802.....35
 KTI41807.....38; 202
 KTI41808.....38; 202
 KTI41809.....38; 202
 KTI41810.....38; 202
 KTI41811.....38; 202
 KTI41812.....38; 202
 KTI41813.....38; 202
 KTI41814.....38; 202
 KTI41815.....38; 202
 KTI41816.....38; 202
 KTI41817.....38; 202
 KTI41818.....38; 202
 KTI41819.....38; 202
 KTI41820.....38; 202
 KTI41821.....38; 202
 KTI41822.....38; 202
 KTI41823.....38; 202
 KTI41824.....38; 202
 KTI41825.....38; 202
 KTI41826.....38; 202
 KTI41827.....38; 202

Part # Page#

KTI41828.....38; 202
 KTI41829.....38; 202
 KTI41830.....38; 202
 KTI41831.....38; 202
 KTI41832.....38; 202
 KTI41833.....38; 202
 KTI41834.....38; 202
 KTI41835.....38; 202
 KTI41836.....38; 202
 KTI42316.....36
 KTI42318.....36
 KTI42320.....36
 KTI42348.....36
 KTI42818.....36
 KTI43100.....44
 KTI43112.....44
 KTI43116.....44
 KTI43120.....44
 KTI43124.....44
 KTI43500.....44
 KTI43510.....44
 KTI43513.....44
 KTI43515.....44
 KTI43518.....44
 KTI43519.....44
 KTI44003.....39
 KTI44412.....39; 201; 210
 KTI44416.....39; 201; 210
 KTI44420.....39; 201; 210
 KTI44500.....39
 KTI44910.....39; 202
 KTI44913.....39; 202
 KTI44917.....39; 202
 KTI45208.....43
 KTI45212.....43
 KTI45216.....43
 KTI45220.....43
 KTI45318.....42
 KTI45400.....42
 KTI45410.....42
 KTI45412.....42
 KTI45414.....42
 KTI45416.....42
 KTI45418.....42
 KTI45420.....42
 KTI45424.....42
 KTI45500.....42
 KTI45508.....42
 KTI45510.....42
 KTI45512.....42
 KTI45513.....42
 KTI45514.....42
 KTI45515.....42
 KTI45518.....42
 KTI45600.....42
 KTI45601.....42
 KTI45602.....42
 KTI45608.....43; 215
 KTI45609.....43; 215
 KTI45610.....43; 215
 KTI45611.....43; 215
 KTI45612.....43; 215
 KTI45613.....43; 215
 KTI45614.....43; 215
 KTI45615.....43; 215
 KTI45616.....43; 215



Part # Page#

KTI45617.....43; 215
 KTI45618.....43; 215
 KTI45619.....43; 215
 KTI45620.....43; 215
 KTI45621.....43; 215
 KTI45622.....43; 215
 KTI45624.....43; 215
 KTI45900.....43
 KTI45901.....43
 KTI45902.....43
 KTI45908.....43; 215
 KTI45910.....43; 215
 KTI45912.....43; 215
 KTI45914.....43; 215
 KTI45916.....43; 215
 KTI45918.....43; 215
 KTI45920.....43; 215
 KTI45922.....43; 215
 KTI45924.....43; 215
 KTI45926.....43; 215
 KTI45928.....43; 215
 KTI45930.....43; 215
 KTI45932.....43; 215
 KTI48004.....40; 204
 KTI48004T.....40
 KTI48006.....40; 204
 KTI48008.....40; 204
 KTI48008T.....40
 KTI48010.....40; 204
 KTI48012.....40; 204
 KTI48012BTW.....40
 KTI48012T.....40
 KTI48015.....40; 204
 KTI48018.....40; 204
 KTI48018T.....40
 KTI49000.....40
 KTI49008.....40; 216
 KTI49010.....40; 216
 KTI49012.....40; 216
 KTI49014.....40; 216
 KTI49018.....40; 216
 KTI49024.....40; 216
 KTI49036.....40
 KTI49112.....40; 216
 KTI49114.....40; 216
 KTI49118.....40; 216
 KTI49124.....40; 216
 KTI49136.....40
 KTI49309.....40
 KTI49315.....40
 KTI49400.....46
 KTI49405.....46
 KTI50201.....192
 KTI51006.....50; 204
 KTI51006T.....50
 KTI51007.....50; 204
 KTI51008.....50; 204
 KTI51103.....49
 KTI51111.....49; 204
 KTI51206.....50
 KTI51211.....49; 204
 KTI51311.....49; 204
 KTI52006.....52; 204
 KTI52006T.....52
 KTI52007.....52; 204
 KTI52007T.....52

Part # Page#

KTI52009.....52
 KTI52107.....52; 204
 KTI53004.....49; 204
 KTI53006.....49; 204
 KTI53006T.....49
 KTI53008.....49; 204
 KTI54006.....49; 204
 KTI54010.....49; 204
 KTI54012.....49; 204
 KTI54050.....52
 KTI54055.....50
 KTI55001.....51
 KTI55012.....51
 KTI55034.....51
 KTI55112.....51; 206
 KTI55120.....51; 206
 KTI55121.....51; 206
 KTI55122.....51; 206
 KTI55123.....51; 206
 KTI55130.....51; 206
 KTI55131.....51; 206
 KTI55132.....51; 206
 KTI55133.....51; 206
 KTI55140.....51; 206
 KTI55141.....51; 206
 KTI55142.....51; 206
 KTI55143.....51; 206
 KTI55912.....51
 KTI55934.....51
 KTI56201.....51; 188; 216
 KTI56202.....51; 188; 216
 KTI56203.....52; 188; 216
 KTI56204.....52; 216
 KTI56205.....52; 188; 216
 KTI56207.....51; 188; 216
 KTI56208.....51; 216
 KTI56209.....52
 KTI57124.....74
 KTI57130.....74
 KTI57136.....74
 KTI57224.....74
 KTI57236.....74
 KTI57318.....74
 KTI57324.....52; 74
 KTI57330.....74
 KTI57336.....74
 KTI57414.....74
 KTI57424.....74
 KTI57436.....74
 KTI57514.....74
 KTI58705.....50; 204
 KTI58707.....50; 204
 KTI58710.....50; 204
 KTI58717.....50; 204
 KTI58809.....50; 204
 KTI58811.....50; 204
 KTI59000.....53
 KTI60060.....108
 KTI61002.....104
 KTI61076.....104
 KTI61077.....104
 KTI61202.....103
 KTI61205.....103
 KTI61211.....103
 KTI61222.....103
 KTI62108.....105

Part # Page#

KTI62110.....105
 KTI62114.....105
 KTI62115.....106
 KTI62116.....105
 KTI63098.....98
 KTI63099.....98
 KTI63100.....98
 KTI63101.....99
 KTI63103.....98
 KTI63105.....99
 KTI63131.....98
 KTI63133.....99
 KTI63134.....102
 KTI63136.....102
 KTI63155.....99
 KTI63186.....99
 KTI63194.....100
 KTI63194COMBO.....100
 KTI63198.....100
 KTI63201.....97
 KTI63207.....97
 KTI63213.....97
 KTI63214.....97
 KTI63221.....97
 KTI63224.....97
 KTI63228.....98
 KTI63230.....97
 KTI63250.....97
 KTI63414.....106
 KTI63421.....106
 KTI63427.....106
 KTI63500.....101
 KTI63502.....101
 KTI63505.....101
 KTI63515.....102
 KTI63517.....102
 KTI63611.....108
 KTI63619.....108
 KTI63703.....107
 KTI63709.....107
 KTI63716.....107
 KTI63800.....110
 KTI63820.....110
 KTI64001.....126
 KTI64005.....126
 KTI64006.....126
 KTI64008.....126
 KTI64105.....126
 KTI64106.....126
 KTI64108.....126
 KTI70002.....34; 207
 KTI70004.....32
 KTI70005.....32
 KTI70006.....32; 33
 KTI70007.....32; 33
 KTI70008.....32; 33
 KTI70009.....32; 33
 KTI70010.....76
 KTI70013.....77
 KTI70014.....32; 33
 KTI70015.....32; 33
 KTI70016.....73
 KTI70017.....32; 33
 KTI70018.....32; 33
 KTI70019.....33
 KTI70020.....33; 205

Part # Page#

KTI70021.....33
 KTI70022.....33
 KTI70023.....33; 205
 KTI70024.....33; 205
 KTI70025.....33; 205
 KTI70026.....33; 205
 KTI70027.....33
 KTI70028.....33; 205
 KTI70029.....33; 205
 KTI70031.....192
 KTI70032.....192
 KTI70033.....192
 KTI70034.....192
 KTI70035.....192
 KTI70036.....192
 KTI70037.....193
 KTI70037-10.....193; 223
 KTI70038.....193
 KTI70038-10.....193; 223
 KTI70040.....72; 211
 KTI70045.....72
 KTI70048.....113; 217
 KTI70050.....114
 KTI70052.....113; 217
 KTI70054.....114; 217
 KTI70056.....114; 217
 KTI70057.....114; 217
 KTI70058.....114; 217
 KTI70060.....141
 KTI70060-1.....141
 KTI70061.....141
 KTI70062.....141
 KTI70063.....141
 KTI70064.....141
 KTI70065.....141
 KTI70066.....141
 KTI70067.....141
 KTI70068.....141
 KTI70069.....141
 KTI70070.....31; 211
 KTI70071.....31
 KTI70072.....31
 KTI70073.....31
 KTI70074.....31
 KTI70075.....31; 211
 KTI70076.....31
 KTI70077.....31
 KTI70078.....31
 KTI70079.....31
 KTI70080.....141
 KTI70081.....141
 KTI70082.....141
 KTI70085.....141
 KTI70099.....170
 KTI70131.....142
 KTI70132.....142
 KTI70163.....142
 KTI70182.....126
 KTI70183.....126
 KTI70184.....126
 KTI70186.....126
 KTI70188.....126
 KTI70210.....135
 KTI70211.....135
 KTI70212.....135
 KTI70215.....135



PART NUMBER INDEX

Part # Page#

KPI70216.....135
 KPI70220.....138
 KPI70300.....154
 KPI70301.....162; 212
 KPI70302.....162; 212
 KPI70303.....162; 212
 KPI70304.....162; 212
 KPI70305.....162; 212
 KPI70306.....162; 212
 KPI70311.....163; 208
 KPI70312.....163; 208
 KPI70313.....163; 208
 KPI70321.....163; 208
 KPI70322.....163; 208
 KPI70323.....163; 208
 KPI70330.....154; 208
 KPI70343.....157
 KPI70344.....161; 208
 KPI70348.....154; 212
 KPI70350.....154
 KPI70355.....161
 KPI70356.....157
 KPI70360.....154
 KPI70365.....154; 208
 KPI70370.....156
 KPI70371.....156
 KPI70372.....154
 KPI70375.....156
 KPI70380.....161
 KPI70382.....157
 KPI70383.....157; 208; 212
 KPI70384.....157; 208; 212
 KPI70390.....156
 KPI70390KIT.....157
 KPI70391.....157
 KPI70392.....157
 KPI70393.....157
 KPI70394.....157
 KPI70395.....156
 KPI70396.....156
 KPI70397.....157
 KPI70440.....114; 217
 KPI70450.....114
 KPI70461.....114
 KPI70500.....155
 KPI70510.....156
 KPI70540.....192
 KPI70541.....192
 KPI70545.....192
 KPI70546.....73; 192
 KPI70550.....193
 KPI70551.....193
 KPI70600.....164
 KPI70715.....168
 KPI70720.....164
 KPI70721.....164
 KPI70722.....164
 KPI70723.....164
 KPI70724.....164
 KPI70725.....164
 KPI70726.....164
 KPI70727.....164
 KPI70728.....164
 KPI70730.....164
 KPI70731.....164
 KPI70732.....164

Part # Page#

KPI70750.....177
 KPI70816.....143
 KPI70900.....169
 KPI70901.....169
 KPI70903.....169
 KPI70904.....169
 KPI70905.....169
 KPI70909.....169
 KPI70910.....170
 KPI70915.....170
 KPI70920.....170
 KPI70921.....170
 KPI70922.....170
 KPI70999.....170
 KPI71000.....94
 KPI71001.....94
 KPI71002.....94
 KPI71003.....94
 KPI71005.....93; 222
 KPI71010.....89
 KPI71011.....89
 KPI71012.....89
 KPI71013.....89
 KPI71015.....89
 KPI71016.....89
 KPI71025.....94
 KPI71100.....164
 KPI71103.....164
 KPI71105.....164
 KPI71106.....164
 KPI71108.....164
 KPI71200.....71
 KPI71233.....72
 KPI71235.....72
 KPI71236.....72
 KPI71237.....72
 KPI71300.....77
 KPI71301.....77
 KPI71303.....77
 KPI71306.....77
 KPI71400.....27; 211
 KPI71420.....27; 211
 KPI71425.....27
 KPI71475.....27; 211
 KPI71480.....27; 211
 KPI71501.....155
 KPI71502.....155
 KPI71519.....155
 KPI71550.....155
 KPI71555.....155
 KPI71556.....155
 KPI71600.....32
 KPI71606.....32
 KPI71612.....32
 KPI71616.....32
 KPI71620.....32
 KPI71700.....47; 205
 KPI71704.....47; 205
 KPI71708.....47; 205
 KPI71714.....47; 205
 KPI71715.....47; 205
 KPI71716.....47; 205
 KPI71724.....47; 205
 KPI71725.....47; 205
 KPI71732.....47; 205
 KPI71733.....47; 205

Part # Page#

KPI71751.....47; 205
 KPI71771.....47
 KPI71782.....47
 KPI71783.....47
 KPI71910.....149
 KPI71920.....149
 KPI71921.....149
 KPI71922.....149
 KPI71923.....149
 KPI71924.....149
 KPI71925.....149
 KPI71926.....149
 KPI71927.....149
 KPI71930.....148
 KPI71931.....148
 KPI71932.....148
 KPI71933.....148
 KPI71934.....148
 KPI71940.....148
 KPI71980.....148
 KPI71981.....116
 KPI71982.....116
 KPI71989.....115
 KPI71990A.....115
 KPI71991.....115
 KPI71992.....116
 KPI71993.....116
 KPI71996.....116
 KPI71997.....116
 KPI71999.....115
 KPI72000.....93
 KPI72001.....90
 KPI72002.....90
 KPI72003.....90
 KPI72004.....90
 KPI72005.....90
 KPI72006.....90
 KPI72007.....93
 KPI72008.....93
 KPI72009.....93
 KPI72010.....90
 KPI72011.....90
 KPI72012.....90
 KPI72013.....90
 KPI72014.....90
 KPI72015.....90
 KPI72016.....90
 KPI72017.....92
 KPI72018.....92
 KPI72019.....92
 KPI72020.....92
 KPI72021.....92
 KPI72022.....92
 KPI72023.....92
 KPI72025.....90
 KPI72035.....90
 KPI72036.....90
 KPI72037.....90
 KPI72038.....90
 KPI72039.....92
 KPI72041.....92
 KPI72042.....92
 KPI72043.....92
 KPI72044.....93
 KPI72045.....93
 KPI72046.....94

Part # Page#

KPI72047.....92
 KPI72048.....90; 92
 KPI72049.....90
 KPI72050.....90
 KPI72079.....125
 KPI72080.....125
 KPI72081.....125
 KPI72082.....125
 KPI72083.....125
 KPI72084.....125
 KPI72085.....125
 KPI72100.....45
 KPI72101.....45
 KPI72102.....45
 KPI72117.....45
 KPI72118A.....45
 KPI72120A.....45
 KPI72121A.....45
 KPI72125A.....45
 KPI72126A.....45
 KPI72130.....46
 KPI72132.....46
 KPI72133.....46
 KPI72134.....46
 KPI72135.....46
 KPI72138.....46; 219
 KPI72140.....45
 KPI72141.....45
 KPI72142.....45
 KPI72143.....45
 KPI72145.....45
 KPI72149.....46
 KPI72175.....45
 KPI72176A.....45
 KPI72180.....30
 KPI72190.....46
 KPI72200.....129
 KPI72205.....129
 KPI72210.....129
 KPI72215.....129
 KPI72250.....129
 KPI72261.....143
 KPI72310.....73; 168
 KPI72320.....73; 168
 KPI72330.....73; 168
 KPI72340.....73; 168
 KPI72345.....73; 168
 KPI72355.....73; 168
 KPI72355-1.....73; 168
 KPI72380.....52; 76
 KPI72450.....57
 KPI72451.....57
 KPI72460.....57
 KPI72465.....57
 KPI72470.....58
 KPI72471.....58
 KPI72472.....58
 KPI72473.....58
 KPI72475.....58
 KPI72476.....58
 KPI72477.....58
 KPI72478.....58
 KPI72505.....34; 205
 KPI72512.....34; 205
 KPI72514.....34; 205
 KPI72523.....34; 205



Part # Page#

KTI72543.....34; 205
 KTI72553.....34; 205
 KTI72606.....53
 KTI72608.....53
 KTI72610.....53
 KTI72612.....53
 KTI72616.....53
 KTI72625.....53
 KTI72644.....53
 KTI72765.....189
 KTI72770.....189
 KTI72771.....189
 KTI72780.....189
 KTI72781.....189
 KTI72782.....189
 KTI72790.....189
 KTI72791.....189
 KTI72792.....189
 KTI72801.....76
 KTI72802.....76
 KTI72900.....33; 207
 KTI72901.....33; 207
 KTI72901K.....33
 KTI72911.....33; 34; 207
 KTI72912.....33; 34; 207
 KTI72913.....33; 34; 207
 KTI72914.....33; 34; 207
 KTI72915.....33; 34; 207
 KTI72916.....33; 34; 207
 KTI72921.....33; 34; 207
 KTI72922.....33; 34; 207
 KTI72923.....33; 34; 207
 KTI72924.....33; 34; 207
 KTI72925.....33; 34; 207
 KTI72931.....33; 34; 207
 KTI72932.....33; 34; 207
 KTI72980.....33
 KTI72982.....33; 34; 207
 KTI72984.....33; 34; 207
 KTI72986.....33; 34; 207
 KTI72988.....33; 34; 207
 KTI73000.....34; 207
 KTI73012.....33; 34; 207
 KTI73016.....33; 34; 207
 KTI73020.....33; 34; 207
 KTI73024.....34; 207
 KTI73028.....34; 207
 KTI73102.....72
 KTI73103.....72
 KTI73104.....73
 KTI73104-1.....73
 KTI73105.....73
 KTI73110.....72
 KTI73150.....72
 KTI73155.....72
 KTI73201.....109
 KTI73202.....109
 KTI73303.....64
 KTI73304.....64
 KTI73305.....65
 KTI73306.....65
 KTI73307.....68
 KTI73311.....65
 KTI73312.....65
 KTI73315.....67
 KTI73318.....67

Part # Page#

KTI73330.....67
 KTI73333.....68
 KTI73335.....67; 68
 KTI73340.....69
 KTI73341.....68
 KTI73342.....69
 KTI73343.....69
 KTI73345.....69
 KTI73346.....69
 KTI73348.....69
 KTI73349.....67
 KTI73350.....64
 KTI73351.....64
 KTI73355.....64
 KTI73356.....65
 KTI73357.....65
 KTI73358.....64
 KTI73359.....64
 KTI73360.....64
 KTI73362.....64
 KTI73363.....67
 KTI73370.....66
 KTI73371.....68
 KTI73372.....66
 KTI73373.....63
 KTI73374.....63
 KTI73375.....66
 KTI73379.....217
 KTI73380.....69
 KTI73381.....69
 KTI73386.....62
 KTI73387.....61; 217
 KTI73388.....62; 217
 KTI73389.....61; 217
 KTI73394.....217
 KTI73396.....62; 217
 KTI73397.....65
 KTI73398.....217
 KTI73398A.....62
 KTI73399.....61; 217
 KTI73400.....76
 KTI73510.....127
 KTI73550.....127
 KTI73560.....127
 KTI73600.....158; 211
 KTI73601.....158; 211
 KTI73602.....158; 211
 KTI73603.....158; 211
 KTI73605.....158; 211
 KTI73606.....158; 211
 KTI73607.....159
 KTI73608.....159
 KTI73609.....159
 KTI73610.....159
 KTI73611.....159
 KTI73612.....159
 KTI73613.....159
 KTI73613N.....159
 KTI73614.....159
 KTI73615.....159
 KTI73616.....159
 KTI73617.....159
 KTI73618.....159; 211
 KTI73619.....159; 211
 KTI73620.....158; 211
 KTI73621.....158; 211

Part # Page#

KTI73623.....159
 KTI73624.....159
 KTI73625.....159
 KTI73626.....159
 KTI73627.....159
 KTI73628.....159
 KTI73630.....159; 211
 KTI73635.....158; 211
 KTI73701.....177
 KTI73701-50.....177
 KTI73730.....158; 211
 KTI73731.....158; 211
 KTI73801.....110; 207
 KTI73802.....110; 207
 KTI73803.....110; 207
 KTI73810.....110
 KTI73811.....110
 KTI73812.....110
 KTI73813.....110
 KTI73814.....110
 KTI73818.....111
 KTI73819.....111
 KTI73822.....111
 KTI73823.....111
 KTI73824.....111
 KTI73825.....111
 KTI73830.....111
 KTI73831.....111
 KTI73832.....111
 KTI73833.....111
 KTI73834.....111
 KTI73849.....111
 KTI73850.....111
 KTI73851.....111
 KTI73861.....112; 207
 KTI73862.....112; 207
 KTI73864.....112; 207
 KTI73870.....112; 207
 KTI73871.....112; 207
 KTI73873.....112; 207
 KTI73900.....128
 KTI73901.....131
 KTI73902.....131
 KTI73903.....129; 219
 KTI73905.....128
 KTI73910.....128; 223
 KTI73912.....129; 219
 KTI73918.....129; 219
 KTI73919.....128; 219
 KTI73930.....128; 219
 KTI73933.....128; 219
 KTI73942.....128; 219
 KTI73952.....129; 219
 KTI73952-54.....129; 223
 KTI73957.....129; 219
 KTI73959.....128; 219
 KTI73962.....128
 KTI73993.....129
 KTI74005.....77
 KTI74010.....77
 KTI74015.....77
 KTI74020.....77
 KTI74025.....77
 KTI74030.....77
 KTI74103.....77
 KTI74106.....77

Part # Page#

KTI74107.....77
 KTI74108.....77
 KTI74308.....138
 KTI74500.....136
 KTI74505.....136
 KTI74510.....136
 KTI74521.....137
 KTI74523.....137
 KTI74524.....137
 KTI74530.....137
 KTI74535.....138
 KTI74536.....138
 KTI74537.....138
 KTI74538.....138
 KTI74601-1.....131
 KTI74601-12.....131
 KTI74602-1.....131
 KTI74602-12.....131
 KTI74603.....131
 KTI74604.....131
 KTI74605.....130
 KTI74606.....130
 KTI74607.....130
 KTI74608.....130
 KTI74609.....130
 KTI74610.....130
 KTI74611.....130
 KTI74612.....130
 KTI74613.....130
 KTI74630.....131
 KTI74640.....130
 KTI74641.....130
 KTI74645.....131
 KTI74647.....131
 KTI74650.....131
 KTI74651.....131
 KTI74652.....131
 KTI74951.....109
 KTI74956.....109
 KTI74957.....109
 KTI74958.....109
 KTI74959.....109
 KTI74961.....109
 KTI74981.....109
 KTI75105.....55
 KTI75140.....56
 KTI75141.....56
 KTI75142.....56
 KTI75143.....56
 KTI75145.....56
 KTI75146.....55
 KTI75201.....177
 KTI75202.....177
 KTI75300.....172
 KTI75305.....171
 KTI75306.....172
 KTI75310.....171
 KTI75311.....171
 KTI75312.....171
 KTI75320.....164
 KTI75321.....164
 KTI75322.....164
 KTI75323.....164
 KTI75324.....164
 KTI76000.....113; 203



PART NUMBER INDEX

Part # Page#

KTI76004.....113
 KTI76040.....112; 203
 KTI76070.....112; 203
 KTI76110.....112; 203
 KTI76140.....112; 203
 KTI76145.....112; 203
 KTI76180.....112
 KTI76240.....112
 KTI76360.....112
 KTI77070.....112; 203
 KTI77140.....112; 203
 KTI78004.....113
 KTI78040.....112; 203; 219
 KTI78070.....112; 203
 KTI78110.....112; 203
 KTI78140.....112; 203
 KTI78145.....112; 203
 KTI78180.....112
 KTI78240.....112
 KTI78360.....112
 KTI79100.....192
 KTI79110.....192
 KTI79200.....77
 KTI79201.....77
 KTI79205.....77
 KTI79210.....77
 KTI79215.....77
 KTI79216.....77
 KTI79217.....77
 KTI79220.....77
 KTI79225.....77
 KTI79800.....63
 KTI79801.....63
 KTI80955.....191
 KTI80989.....191
 KTI80995.....191
 KTI80996.....191
 KTI80998.....191
 KTI81380.....95
 KTI81550.....80
 KTI81560.....80
 KTI81565.....80
 KTI81622.....80
 KTI81631A.....80
 KTI81632A.....80
 KTI81772A.....81
 KTI81774.....81
 KTI81775.....81
 KTI81795.....81
 KTI81797A.....81
 KTI81798A.....81
 KTI81900.....83; 208

Part # Page#

KTI81956.....83; 208
 KTI81958.....83; 208
 KTI81959.....83; 208
 KTI81968.....83; 208
 KTI81972.....83; 208
 KTI81973.....83; 208
 KTI81974.....83; 208
 KTI81975.....83; 208
 KTI81976.....83; 208
 KTI81977.....83; 208
 KTI81979.....83; 208
 KTI81982.....83; 208
 KTI81986.....83; 208
 KTI81995.....83; 155; 208
 KTI81996.....83; 155; 208
 KTI81997.....83; 208
 KTI82500A.....79
 KTI82503A.....79
 KTI82504.....79
 KTI83090.....83
 KTI83091.....83; 208
 KTI83092.....83; 208
 KTI83093.....83; 208
 KTI83275.....82
 KTI83277.....82
 KTI83280.....87
 KTI84218.....82
 KTI84228.....82
 KTI84229.....82
 KTI85004.....86
 KTI85005.....86
 KTI85006.....86
 KTI85007.....86
 KTI85008.....86
 KTI85265.....85
 KTI85695.....86
 KTI85696.....86
 KTI85697.....86
 KTI85746.....85
 KTI85800.....85
 KTI85807.....86
 KTI85811.....86
 KTI85846.....85
 KTI87125.....84
 KTI87126.....84
 KTI87128.....84
 KTI87130.....82
 KTI87132.....84
 KTI87135.....84
 KTI87140.....77
 KTI87141.....77
 KTI88255.....88

Part # Page#

KTI89001.....148
 KTI89002.....148
 KTI89003.....148
 KTI89110.....88
 KTI89115.....88
 KTI89191.....191
 KTI89193.....191
 KTI89194.....191
 KTI89195.....191
 KTI89218.....88
 KTI89220.....88
 KTI89257.....87
 KTI89275.....87
 KTI89276.....87
 KTI90002.....127
 KTI90002C.....127
 KTI90003.....127; 223
 KTI90003C.....127; 223
 KTI90005.....127
 KTIHOOK1.....195; 196; 198;
 201; 202; 203;
 209; 210; 211;
 215; 220
 KTIHOOK2.....195; 196; 197;
 198; 199; 200;
 201; 202; 203;
 204; 205; 206;
 207; 208; 209;
 210; 211; 212;
 213; 215; 216;
 216; 217; 218;
 219; 220
 KTIHOOK3.....195; 196; 217; 220
 KTIHOOK7.....218; 219; 220
 KTIHOOK8.....199; 204; 214;
 218; 220
 KTIOL0805.....195
 KTIOL0806.....196
 KTIOL0807.....197
 KTIOL0808.....198
 KTIOL0809.....199
 KTIOL0810.....200
 KTIOL0811.....200
 KTIOL0812.....201
 KTIOL0813.....202
 KTIOL0814.....203
 KTIOL0815.....203
 KTIOL0816.....204
 KTIOL0817.....204
 KTIOL0819.....205
 KTIOL0820.....205
 KTIOL0821.....206
 KTIOL0822.....207

Part # Page#

KTIOL0831.....207
 KTIOL0832.....208
 KTIOL0833.....208
 KTIOL0834.....209
 KTIOL0835.....210
 KTIOL0836.....211
 KTIOL0837.....211
 KTIOL0838.....212
 KTIOL0839.....213
 KTIOL0840.....214
 KTIOL0842.....215
 KTIOL0843.....220
 KTIOL0844.....216
 KTIOL0845.....216
 KTIOL0846.....217
 KTIOL0847.....217
 KTIOL0848.....218
 KTIOL0849.....218
 KTIOL0850.....199
 KTIOL0852.....219
 KTIOL0881.....219
 KTIOLF04333.....195; 196; 197;
 198; 199; 200;
 201; 202; 203;
 204; 205; 206;
 207; 208; 209;
 210; 211; 212;
 213; 214; 215;
 216; 217; 218;
 219; 220
 KTIIPREPACKQ1.....30; 222
 MCP72400.....58
 MCP72401.....58
 MCP72402.....58
 MCP72403.....58
 MCP72404.....58
 MCP72405.....58
 MCP72421.....59
 MCP72422.....59
 MCP72423.....59
 MCP72424.....59
 MCP72425.....59
 MCP72426.....59
 MCP72441.....59
 MCP72442.....59
 MCP72443.....59
 MCP72453.....59
 MCP72455.....59
 MCP72460.....59



HEAVYWEIGHT QUALITY. KNOCKOUT PRICE.



DESCRIPTIVE INDEX



1/2in. Drive Chrome Reducers	22	Accessories, Air Tools	83	Ball Pien Hammers	47
1/2in. Drive Chrome Socket Accessories	22	Accessories, Battery Terminal	139	Barrel Pumps	129
1/2in. Drive Chrome Sockets	13-14	Accessories, Chrome Socket	20-23	Battery Accessories	139
1/2in. Drive Chrome U-Joints	22	Accessories, Impact Socket	23-24	Battery Bolts	139
1/2in. Drive Extensions, Impact	23	Accessories, Spray Guns	191	Battery Terminal Cleaner	138
1/2in. Drive Flex Handles	22	Accessories, Wall Displays	220-221	Battery Terminal Mounts	139
1/2in. Drive Heating Element Socket, Chrome	22	Accutorq Displays	219	Battery Testers	135
1/2in. Drive Impact Socket Accessories	23	AccuTorq Sockets	150-153	Bearing Separator	157
1/2in. Drive Impact Sockets	14-16	Adapter, 1/2in. Drive Chrome Socket	22	Belt Installation Tools	164
1/2in. Drive Impact U-Joints	23	Adapter, 1/2in. Drive Impact Socket	23	Bench Grinder	108
1/2in. Drive Ratchets, Chrome	22	Adapter, 1/4in. Drive Chrome Socket	20	Bender, Tubing	168
1/2in. Drive Reducers, Impact	23	Adapter, 1in. Drive Impact Socket	24	Bit Holder	49
1/2in. Drive Sockets, External Torx	25	Adapter, 3/4in. Drive Chrome Socket	23	Bit Sets	48
1/2in. Drive Sockets, Internal Torx	25	Adapter, 3/4in. Drive Impact Socket	24	Blanket, Safety	114
1/4in. Drive Chrome Socket Accessories	20	Adapter, 3/8in. Drive Chrome Socket	21	Blanket, Welding	114
1/4in. Drive Chrome Sockets	5-6	Adapter, 3/8in. Drive Impact Socket	23	Blow Guns	89
1/4in. Drive Chrome U-Joints	20	Adapters, Brake Line	147	Body Clip Pliers	192
1/4in. Drive Flex Handles	20	Adapters, Fuel Sender	174	Bolt Cutters	52,74
1/4in. Drive Ratchets, Chrome	20	Adapters, Fuel System	175	Bolts, Battery	139
1/4in. Drive Sockets, External Torq	25	Adapters, Master Cylinder	144	Booster Cable Clamps	138
1/4in. Drive Sockets, External Torx	25	Adapters, Spindle	77	Booster Cables	136-137
1/4in. Drive Sockets, Internal Torq	26	Adapters, Transmission Jack	102	Bottle Jacks	97-98
1/4in. Drive Sockets, Internal Torx	25	Adhesive Displays	223	Brake Adapter Kit	144
1/4in. Drive Sockets, Tamper-proof Torx	26	Adhesives	127	Brake Bleeder Screws	143, 145
1in. Drive Extensions, Impact	24	Adjustable Pullers	163	Brake Bleeding Kit	143
1in. Drive Impact Socket Accessories	24	Adjustable Torque Wrenches	45	Brake Caliper Hex Bit Sets	142
1in. Drive Impact Sockets	19	Adjustable Wrenches	40	Brake Caliper, Digital	143
3/4in. Drive Breaker Bar, Chrome	23	Air Accessories	83	Brake Flaring Tools	141
3/4in. Drive Chrome Socket Accessories	23	Air Drills	82	Brake Line Adapters	147
3/4in. Drive Chrome Sockets	17	Air Hammers	82	Brake Line Fittings	144-146
3/4in. Drive Chrome U-Joints	23	Air Hose Promo Pack	93	Brake Line Unions	147
3/4in. Drive Impact Socket Accessories	24	Air Hoses	90-91	Brake Lines	146
3/4in. Drive Impact Sockets	18-19	Air Hydraulic Foot Pump	107	Brake Piston Tool	142
3/4in. Drive Impact U-Joints	24	Air Hydraulic Jacks	100	Brake Service Torq Sockets	142
3/4in. Drive Ratchets, Chrome	22	Air Impact Wrenches	80-81	Brake Spring Tools	142
3/4in. Drive Reducers, Impact	24	Air Polisher Accessories	86	Brake Tools	142-147
3/8in. Drive Chrome Socket Accessories	21	Air Ratchets	79	Brass Hammers	47
3/8in. Drive Chrome Sockets	6-10	Air Regulators	191	Breaker Bar, 3/4in. Drive Chrome	23
3/8in. Drive Chrome U-Joints	21	Air Sander Accessories	86	Brushes	77
3/8in. Drive Extensions, Impact	23	Air Shear Cutter	88	Bucket Pump	129
3/8in. Drive Flex Handles	21	Air Specialty Tools	87	Budd Wheel Socket Set	149
3/8in. Drive Impact Socket Accessories	23	Air Tools and Electric Tools	79-95	Bungee Cords	111
3/8in. Drive Impact Sockets	11-12	Air Tools Ratchets	79	Butane Fuel	114
3/8in. Drive Impact U-Joints	23	Alligator Clips	139	Butane Lighters	113
3/8in. Drive Ratchets, Chrome	21	Aluminum Pipe Wrenches	40	Butt Connectors	187-188
3/8in. Drive Sockets, Brake Caliper	24-25	Aluminum Service Jacks	98, 101	Cable Cutters	52
3/8in. Drive Sockets, External Torq	25	Angle Grinder	95	Cable Ties	112-113
3/8in. Drive Sockets, External Torx	25	Angle Work Lights	65	Cables, Booster	135-137
3/8in. Drive Sockets, Hex Bit	24	Antifreeze Drain Pan	131	Car Dollies	110
3/8in. Drive Sockets, Internal Torq	26	Antifreeze Testers	135	Carbon Pile Load Testers	135
3/8in. Drive Sockets, Internal Torx	25	Automotive Test and Bleed Kit	143	C-Clamps	126
3/8in. Drive Sockets, Tamper-proof Torx	26	Awls	76	Charging Post Extenders	139
3/8in. Drive Sockets, Torq	25	Axle Drain Pan	130-131	Chart, Torque	152
3/8in. Drive Sockets, Torq Bit	25	Axle Jacks	100	Child Safety Blanket	114
3/8in. Drive Speed Handle	21	Ball Joint Separator	155	Chisel Displays	207
A/C O-Rings	165	Ball Joint Service Tools	155	Chisel Sets	33-34



DESCRIPTIVE INDEX

Chrome Extensions, 1/2in. Drive	22	Creepers	109	Displays, Wrenches	201-204, 209-210, 215, 216
Chrome Extensions, 1/4in. Drive	20	Creeper Seats	109	Dollies	110
Chrome Extensions, 3/4in. Drive	23	Crimper, Terminal	52	Double Flaring Tools	141
Chrome Extensions, 3/8in. Drive	21	Crimpers, Wire	188	Drain Pans	130-131
Chrome Extensions, Wobble	20, 21	Crimping Tools	52	Drain Plug Gaskets	159
Chrome Flex Handles	20, 21, 22	Cup Brushes	77	Drain Plugs	160
Chrome Ratchets, 1/2in. Drive	22	Cut Off Discs	77	Drill Bit Sets	71-72
Chrome Ratchets, 1/4in. Drive	20	Cut-Off Tool	88	Drills, Air	82
Chrome Ratchets, 3/4in. Drive	22	Cutter, Hose and Pipe	168	Drills, Hex Washer	166
Chrome Ratchets, 3/8in. Drive	21	Cutter, Tubing	168	Drip Trays	130-131
Chrome Socket Accessories	20-23	Cutting, Threading and Abrasives	71-77	Drive Tools Displays	195, 198, 218
Chrome Socket Accessories, 1/2in. Drive	22	Diagonal Cutters	52	Drum Pump	129
Chrome Socket Accessories, 1/4in. Drive	20	Die Grinders	84	Duct Tape	127
Chrome Socket Accessories, 3/4in. Drive	23	Digital Torque Wrenches	46	DVT Sensors	117
Chrome Socket Accessories, 3/8in. Drive	21	Disc Brake Piston Tool	142	Dyna Loom	188
Chrome Socket Adapters	20, 21, 22, 23	Display Accessories	220-221	Dynamic Dual Valve Replacements	117
Chrome Sockets	5-10, 13-14, 17	Display Boards, Blank	221	E-Clips	165
Chrome Sockets, 1/2in. Drive	13-14	Display Hardware	220	Electric Impact Wrench	95
Chrome Sockets, 1/4in. Drive	5-6	Display Hooks	220	Electrical Component Displays	215
Chrome Sockets, 3/4in. Drive	17	Display Shelves	220	Electrical Service	177-189
Chrome Sockets, 3/8in. Drive	6-10	Displays	195-223	Electrical Tape	127
Chrome Spinner Handle	20	Displays, Accutorq	219	Emergency Safety Flare	63
Chrome T-Handles	20, 21, 22, 23	Displays, Adhesive	223	Engine Crane	106
Chrome U-Joints	20, 21, 22, 23	Displays, Chisels	207	Engine Mechanical	158-167
Circuit Testers	189	Displays, Clamps	204	Engine Sling	106
Clamp Displays	204	Displays, Clip Lifter	223	Engine Stands	105
Clamp, Welding	50	Displays, Combi Wedge	223	Engine Support Bars	105
Clamps	126	Displays, Counter	223	Exhaust Grommet Pliers	50
Clamps, Booster Cable	138	Displays, Drive Tools	195, 198, 218	Extension Cords	69
Clamps, Fuel Line	174	Displays, Electrical Components	215	Extensions, 1/2in. Drive Chrome	22
Clamps, Line	164	Displays, Files and Scrapers	205	Extensions, 1/2in. Drive Impact	23
Claw Hammer	47	Displays, Floor	222	Extensions, 1/4in. Drive Chrome	20
Cleaner, Battery Terminal	138	Displays, Grease Guns	223	Extensions, 1in. Drive Impact	24
Cleaner, Glass	125-126	Displays, Hammers	205	Extensions, 3/4in. Drive Chrome	23
Cleaner, Paint Spray Gun	191	Displays, Hand Tools	222	Extensions, 3/8in. Drive Chrome	21
Clip Lifter	193	Displays, Hex Keys	211	Extensions, 3/8in. Drive Impact	23
Clip Lifter Displays	223	Displays, Hoses	222	Extensions, Chrome	20, 21, 22, 23
Clips, Alligator	139	Displays, Impact Sockets	212-214, 218	Extensions, Torque	150
Coil Spring Compressor	156	Displays, Lighting	217	Extensions, Wobble Chrome	20, 21
Combi Wedge	193	Displays, Lubrication	219, 223	Extractor, Spark Plug	177
Combi Wedge Displays	223	Displays, Nutdrivers	211	Extractors	72
Compressor, Coil Spring	156	Displays, Nylon Ties	203	Fender Covers	109
Compressor, Strut Spring	154, 156	Displays, Oil Filter Wrenches	211	File and Scraper Displays	205
Connectors, Butt	187-188	Displays, Pliers	204, 206, 209-210	Files	34
Connectors, Fuel Line	171	Displays, Pneumatic Bits	208	Filters, Spray Guns	191
Connectors, Shrink Tube	185	Displays, Pullers	208, 212	Fittings, Brake Line	144-146
Copper Lug Terminals	185	Displays, Punches	207	Fittings, Fuel Line	172, 175
Copper Lugs	185	Displays, Screwdrivers	199	Fittings, Grease	132-133
Copper Washers	166	Displays, Separators	212	Flare Nut Wrenches	39
Cords, Bungee	111	Displays, Sockets	195, 197, 198, 200, 209-210, 212-214	Flaring Tools	141
Cords, Stretch	111	Displays, Torches	217	Flex Handles, Chrome	20, 21, 22
Cotter Pins	165	Displays, Tow Straps	207	Flex Retriever, Magnetic	169-170
Counter Displays	223	Displays, Wall	195-219	Flexible Line Clamps	164
Couplers, Grease Guns	128-129	Displays, Wire Tools	216	Floor Displays	222
Cover, Fender	109			Fluids and Grease	128-133
Crane, Engine	106				

Folding Knives	72	Heating Element Socket, 1/2in. Drive Chrome	22	Lighting Displays	217
Fuel Filter Repair Lines	174, 176	Hex Bit Sockets	24, 142	Line Clamps, Flexible.....	164
Fuel Line.....	174	Hex Bits.....	49	Line, Fuel.....	174
Fuel Line Clamps.....	174	Hex Key Displays	211	Locking C Clamp.....	50
Fuel Line Connectors.....	171	Hex Keys	27	Locking Pliers.....	50
Fuel Line Disconnect.....	171	Hex Washer Drills	166	Locking Welding Clamp	50
Fuel Line Disconnect Press	172	High Lift Transmission Jacks	101	Locknut Set	149
Fuel Line Fittings	172, 175	Hitch Pins	165	Long-Jaw Pullers.....	154
Fuel Line Installer	171	HNBR O-Rings	166	Low Profile Transmission Jacks.....	102
Fuel Line Quick Connects.....	173	Holster, TPMS Tool	116	Lubrication Displays.....	219, 223
Fuel Line Retainer Clips	173	Hooks, Picks & Awls	31	Lugnut Wrenches.....	148
Fuel Line Tools	174	Hose and Pipe Cutter	168	Magnetic Mat	59
Fuel Sender Adapters.....	174	Hose Displays	222	Magnetic Parts Dish.....	170
Fuel System Adapters.....	175	Hose Pliers	164	Magnetic Retrievers.....	169-170
Fuel, Butane	114	Hose Reels.....	68, 94	Magnetic Tool Holder.....	57
Funnels.....	130-131	Hose, Air.....	90-91	Maintenance Kit, TPMS Valve.....	119
Fuse Holders.....	177	Hose, Recoil	94	Mallets, Rubber	47
Fuse Pullers.....	177	Hose, Water	125	Master Cylinder Adapters.....	144
Fuses.....	178-182	Hoses, Whip.....	93-94	Master Drill Bit Set.....	48
Fuses, Glass	178, 181	Hub Removal Tools.....	156-157	Master Fittings.....	145
Fuses, Glo.....	178, 181	Hydraulic Flaring Tools.....	141	Material Handling.....	110-113
Fuses, Jcase.....	179, 182	Hydraulic Foot Pump.....	107	Maxi Fuses	178, 180
Fuses, Maxi	178, 180	Hydraulic Grease Fittings	133	Measuring Pitcher.....	131
Fuses, Mini	180	Hydraulic Truck Jacks.....	100	Measuring Tape.....	53
Gaskets, Drain Plug	159	Impact Driver and Bit Set	47	MegaHammer	156-157
Gauges, Tire Inflator	148	Impact Socket Accessories	23-24	MegaHammer Accessories	157
Glass Cleaner Tool.....	125-126	Impact Socket Displays.....	212-214, 218	Memory Saver	138
Glass Fuses	178, 181	Impact Sockets.....	11-12, 14-16, 18-19	Mini Brush Set.....	77
GlassMaster Kit.....	125-126	Impact Sockets, 1/2in. Drive.....	14-16	Mini Fuses	180
Glo Fuses.....	178, 181	Impact Sockets, 1in. Drive	19	Mirror Telescoping Tools.....	170
Grease Fittings.....	132-133	Impact Sockets, 3/4in. Drive	18-19	Module, TPMS Programming	115
Grease Fittings, Hydraulic	133	Impact Sockets, 3/8in. Drive	11-12	Mounts, Battery Terminal.....	139
Grease Gun Displays.....	223	Impact Wrenches, Air.....	80-81	Needle Nose Plier Sets.....	49-50
Grease Gun Parts and Accessories.....	128-129	Inspection Tools.....	169-170	Needle Scaler	87
Grease Guns	128	ISO Flaring Tools.....	141	Needle, Grease Gun	129
Grinder, Angle.....	95	Jack Stands.....	103	Non-Ratcheting Wrenches	34-40
Grinder, Bench.....	108	Jack, Pallet.....	110	Number and Letter Stamp Set.....	76
Grommet Removal Tool, TPMS.....	124	Jacks, Air Hydraulic	100	Nut Driver Sets	31
Grommets.....	166	Jacks, Aluminum	98, 101	Nut Splitter	168
Groove Joint Pliers.....	49	Jacks, Bottle.....	97-98	Nutdriver Displays.....	211
Guns, Blow	89	Jacks, Scissor	98	Nylon Tie Displays	203
Hacksaws.....	76	Jacks, Service	98-99, 101	Nylon Tie Tightening Tool.....	113
Halogen Work Lights.....	66	Jacks, Transmission	101-102	Oil Can.....	131
Hammer Displays	205	Jacks, Trolley	98	Oil Drain Pan.....	131
Hammers, Air.....	82	Jacks, Truck/Axle	100	Oil Filter Cap Sockets.....	159
Hammers, Ball Pien	47	Jcase Fuses	179, 182	Oil Filter Pliers	158
Hammers, Brass	47	Keys, Hex	27	Oil Filter Wrench Displays	211
Hammers, Claw	47	Kit, Tire Repair.....	148	Oil Filter Wrenches.....	158-159
Hand Held Lights	61--62	Kit, TPMS.....	115, 122-123	Oil Sender Sockets	177
Hand Tool Displays	222	Knife, Utility	72-73	O-Rings	165, 166, 167
Hand Tools	4-53	Knife, Windshield	192	O-Rings, A/C.....	165
Hand Tools Floor Display.....	30	Level Transfer Pump.....	129	O-Rings, HNBR	166
Harmonic Balance Installer	157	Lifting	97-103	Paint and Body Tools	191-193
Harmonic Balancer Puller.....	161	Lighter, Butane	113	Paint Guns.....	191
Head Lamp	62	Lighting	61-69	Pallet Jacks	110
Heat Shrink Tube.....	113, 186			Pans, Drain.....	130-131

DESCRIPTIVE INDEX

- Parts Dish, Magnetic..... 170
- Pilot Bearing Puller 161
- Pilot Bearing Slide Hammer 157
- Pins, Cotter 165
- Pins, Hitch 165
- Pins, Roll 167
- Pipe Cutters..... 73, 168
- Pipe Wrenches..... 40
- Piston Style Oiler 131
- Piston Tool, Disc Brake 142
- Pitcher, Measuring..... 131
- Pitman Arm Pullers 154
- Plier Displays..... 204, 206, 209-210
- Plier, Spark Plug Boot 177
- Pliers, Body Clip..... 192
- Pliers, Brake Spring 142
- Pliers, Hose 164
- Pliers, Locking 50
- Pliers, Needle Nose..... 49-50
- Pliers, Oil Filter 158
- Pliers, Plug 52
- Pliers, Tubing..... 168
- Plug Pliers 52
- Plugs, Drain..... 160
- Pneumatic Bit Displays 208
- Pneumatic Bits 83
- Polishers..... 85, 95
- Portable Ram 107
- Press, Fuel Line Disconnect 172
- Press, Shop 108
- Propane Torch 114
- Pry Bars..... 32
- Puller and Bearing Separator 157
- Puller Displays..... 208, 212
- Puller, Harmonic Balancer..... 161
- Puller, Pilot Bearing 161
- Puller, Pitman Arm..... 154
- Puller, Pulley..... 154
- Puller, Rear Axle Bearing 161
- Puller, Slide Hammer 156
- Puller, Steering Wheel..... 154
- Pullers, Adjustable 163
- Pullers, Fuse..... 177
- Pullers, Long-Jaw 154
- Pullers, Reversible 154, 162, 163
- Pulley Puller..... 154
- Pump, Air Hydraulic Foot..... 107
- Pump, Barrel..... 129
- Pump, Bucket..... 129
- Pump, Drum 129
- Pump, Siphon Transfer 129
- Pump, Transfer 129
- Punch Displays 207
- Punches and Chisels..... 33-34
- Q-Bond Adhesive Kits 127
- Quick Connects, Fuel Line..... 173
- Quick Disconnect, Retainer Clip Kit 168
- Radiator Disconnect Tools..... 164
- Radios, Two Way 170
- Ram, Portable 107
- Ratcheting Wrenches..... 42-44
- Ratchets, 1/2in. Drive 22
- Ratchets, 1/4in. Drive 20
- Ratchets, 3/4in. Drive 22
- Ratchets, 3/8in. Drive 21
- Ratchets, Air 79
- Ratchets, Chrome 20, 21, 22
- Ratchets, Push Button..... 20, 21, 22
- Rear Axle Bearing Puller 161
- Rechargeable Lights 61-63
- Recoil Hose..... 94
- Reducers, 1/2in. Drive Chrome 22
- Reducers, 1/2in. Drive Impact..... 23
- Reducers, 3/4in. Drive Impact..... 24
- Reels, Hose..... 68
- Regulators, Air 191
- Remover, Upholstery Clip..... 192
- Remover, Windshield 192
- Replacement Valve Stems, TPMS..... 118-119
- Retainer Clip Quick Disconnect Kit 168
- Retainer Clips, Fuel Line 173
- Retractable Reels..... 68
- Reversible Pullers 154, 162, 163
- Reversible Snap Ring Plier Set 51
- Rivet Guns 88
- Riveters 192
- Roll Pins 167
- Rope, Tow 111
- Rubber Hoses 90-91
- Rubber Mallet 47
- Rubber Straps..... 111
- Ruler..... 53
- Safety Blanket 114
- Sanders 85-86
- Sanding Pen 193
- Scissor Jacks 98
- Scraper Displays..... 205
- Scrapers 32-33, 73
- Screwdriver Displays 199
- Screwdrivers 28-30
- Screwdrivers, Torq 30
- Screwdrivers, TPMS 116
- Screws, Brake Bleeder..... 143, 145
- Sensor Activation Tool, TPMS 115
- Sensors, TPMS 117
- Separator Displays..... 212
- Separator, Ball Joint 155
- Separator, Puller and Bearing 157
- Separator, Tie Rod 155
- Serpentine Belt Tools..... 164
- Service Carts 55
- Service Jacks 98-99, 101
- Service Jacks, Aluminum..... 98, 101
- Shop Press 108
- Shrink Tube 113
- Shrink Tube Connectors..... 185
- Siphon Transfer Pump 129
- Slide Hammer Puller 156
- Sling, Engine 106
- Slip Joint Pliers..... 49
- Snap Rings 165
- Snips 52, 76
- Socket Accessories, 1/2in. Drive Chrome 22
- Socket Accessories, 1/4in. Drive Chrome 20
- Socket Accessories, 3/4in. Drive Chrome 23
- Socket Accessories, 3/8in. Drive Chrome 21
- Socket Accessories, Chrome..... 20-23
- Socket Accessories, Impact 23-24
- Socket Adapter, 1/2in. Drive Chrome 22
- Socket Adapter, 1/2in. Drive Impact..... 23
- Socket Adapter, 1/4in. Drive Chrome 20
- Socket Adapter, 1in. Drive Impact..... 24
- Socket Adapter, 3/4in. Drive Chrome 23
- Socket Adapter, 3/4in. Drive Impact..... 24
- Socket Adapter, 3/8in. Drive Chrome 21
- Socket Adapter, 3/8in. Drive Impact..... 23
- Socket Adapters, Chrome 20, 21, 22, 23
- Socket Caddies..... 59
- Socket Displays 195, 197, 198, 200, 209-210, 212-214
- Socket Holders 58
- Socket Rails..... 58
- Socket, Heating Element, 1/2in. Drive Chrome ... 22
- Sockets, AccuTorq..... 150-153
- Sockets, Brake Service Torq 142
- Sockets, Budd Wheel..... 149
- Sockets, Chrome 5-10, 13-14, 17
- Sockets, Hex Bit 24
- Sockets, Impact 11-12, 14-16, 18-19
- Sockets, Oil Filter Cap..... 159
- Sockets, Oil Sender 177
- Sockets, Spark Plug..... 177
- Sockets, Tamper-proof Torx 26
- Sockets, Thin Wall 150
- Sockets, Torq 25-26
- Sockets, Torx..... 25-26
- Solderless Terminals 182-184, 186
- Solid Brass Hammers 47
- Spark Plug Boot Pliers 177
- Spark Plug Extractors 177
- Spark Plug Gap Tool 177
- Spark Plug Sockets..... 177
- Specialty Tools, Air 87
- Speed Handle, 3/8in. Drive Chrome 21
- Spindle Adapters 77
- Spinner Handle, 1/4in. Drive 20

Spray Gun Accessories	191	Torque Wrenches.....	45-46	Valve Stems, TPMS.....	118-119, 121-122
Spray Guns	191	Torque Wrenches, Adjustable.....	45	Vises.....	126
Spring Action Scissors	72	Torque Wrenches, Digital.....	46	Wall Display Accessories	220-221
Spring Compressor	154, 156	Torx Sockets.....	25-26	Wall Displays	195-219
Stand, Engine	105	Tow Rope	111	Washers, Hex Drill	166
Stand, Underhoist.....	104	Tow Strap Displays.....	207	Water Hoses	125
Steel Line Stopper	172	Tow Straps	110	Water Pitcher, Measuring.....	131
Steering and Suspension	154-156	TPMS.....	115-124	Waxer	95
Steering Wheel Puller.....	154	TPMS Kits.....	115, 122-123	Wedge, Combi	193
Stopper, Steel Line	172	TPMS Programming Module	115	Welding Blanket.....	114
Strap Wrenches, Oil Filter	158	TPMS Screwdrivers	116	Whip Hoses.....	93-94
Straps, Rubber.....	111	TPMS Sensors	117	Windshield Knife.....	192
Straps, Tie-Down.....	112	TPMS Tool Kit	124	Windshield Removing Tool	192
Straps, Tow	110	TPMS Tools	124	Wire.....	189
Stretch Cords.....	111	TPMS Valve Caps.....	119	Wire Crimpers.....	188
Strippers, Wire.....	51-52	TPMS Valve Core Maintenance.....	119-122	Wire Loom	188
Strut Compressor.....	154, 156	TPMS Valve Core Tools	116, 124	Wire Strippers.....	51-52, 188
Suction Gun.....	128	TPMS Valve Cores.....	119-120	Wire Tool Displays	216
Support, Engine	105-106	TPMS Valve Maintenance Kit.....	119	Wire Wheel	77
Tape Measures	53	TPMS Valve Stems.....	118-119, 121-122	Wobble Extensions, 1/4in. Drive Chrome.....	20
Tape, Duct.....	127	Transfer Pump.....	129	Wobble Extensions, 3/8in. Drive Chrome.....	21
Tape, Electrical	127	Transmission Jacks	101-102	Work Light Accessories.....	68
Tape, Pipe	127	Tray, Drip.....	130-131	Work Lights	61-68
Tapered Scratch Awl.....	76	Trolley Jacks	98	Wrench Displays	201-204, 209-210, 215, 216
Telescopic Tools, Magnetic.....	169-170	Trouble Lights.....	64,67	Wrench, Lugnut	148
Telescopic Tools, Mirror.....	170	Truck Jacks	100	Wrenches, Adjustable	40
Terminal Assortments.....	183	Tube Cutter.....	73	Wrenches, Combination Non-Ratcheting	34-40
Terminal Crimper.....	52	Tube, Heat Shrink.....	113, 186	Wrenches, Combination Ratcheting.....	42-44
Terminals, Copper Lug.....	185	Tube, Shrink	113, 186	Wrenches, Oil Filter.....	158-159
Terminals, Solderless	182-184, 186	Tubing Bender	168	Wrenches, Strap	158
Tester, Carbon Pile Load.....	135	Tubing Bender	73	Wrenches, Torque.....	45-46
Tester, Circuit.....	189	Tubing Cutter.....	168		
Testers, Antifreeze.....	135	Tubing Pliers.....	168		
Testers, Battery	135	Tubing, Cutting and Bending.....	168		
T-Handles, Chrome.....	20, 21, 22, 23	Two Way Radios	170		
Thin Wall Sockets	150	U-Clips	165		
Tie Rod Separator	155	U-Joints, 1/2in. Drive Chrome.....	22		
Tie Rod Tools.....	155	U-Joints, 1/2in. Drive Impact	23		
Tie-Down Straps.....	112	U-Joints, 1/4in. Drive Chrome.....	20		
Ties, Cable.....	112-113	U-Joints, 3/4in. Drive Chrome.....	23		
Tin Snips	52, 76	U-Joints, 3/4in. Drive Impact	24		
Tire and Wheel Tools and Accessories	148-153	U-Joints, 3/8in. Drive Chrome.....	21		
Tire Inflator Gauges	148	U-Joints, 3/8in. Drive Impact	23		
Tire Repair Kit.....	148	U-Joints, Chrome.....	20, 21, 22, 23		
Tool Holder, Magnetic.....	57	Underhoist Stands	104		
Tool Storage	55-59	Unions, Brake Line.....	147		
Tool Storage Parts and Accessories	57	Universal Drum Bung Wrench	46		
Torch Shield	114	Upholstery Clip Removers	192		
Torch, Butane.....	113-114	Utility Carts	56		
Torch, Propane	114	Utility Knives	72-73		
Torq Screwdrivers	30	Vacuum Caps	160-161		
Torq Sockets	25-26	Vacuum Tees.....	160-161		
Torque Chart.....	152	Valve Caps, TPMS.....	119		
Torque Extensions	150	Valve Core Maintenance, TPMS.....	119-122		
Torque Multiplier	46	Valve Core Tools, TPMS	116, 124		
Torque Wrench, TPMS.....	124	Valve Cores , TPMS.....	119-120		

WARRANTY POLICY

Hand Tools - Lifetime Warranty

K-Tool International Hand Tools are warranted against defects in material or workmanship for the life of the tool. Improper use of a tool will void its warranty.

Exceptions to this warranty are as follows:

KTI Hand Tools.....	Lifetime warranty. Excludes package cases/bags/containers and adapters.
TMPS Tools (Sensor Activation Tools)	3-year, repairable item.
KTI Torque Wrenches - U.S.-made	1-year, repairable item.
KTI Torque Wrenches - Digital and Import.....	90-day limited, repairable item. 1/2 price replacement option after 90 days.
KTI Lighting	1-year warranty. Bulbs are not covered.
KTI Pullers - U.S.-made and Import.....	Limited lifetime on parts. Will not warrant entire tool, credit issued for defective part.
KTI Standard Duty Lifting Equipment.....	1-year repair or replace.
KTI Professional & Heavy Duty Lifting Equipment (XD & HD Series).....	2-year repair or replace.
Vises.....	10-year limited warranty.
Battery Boosters and Testers	1-year repair or replace.
Electrical.....	1-year limited warranty.
Mega Hammer	1-year warranty.
Creepers	90-day warranty.
Test Equipment	90-day limited warranty.
Expendables, Non-metal Products	Not covered.
Repair Parts	Not covered.
KTI Air Tools	1-year limited warranty with 30-day* over-the-counter replacement.

**All returns on noted exceptions must be accompanied by a sales receipt.
Should you experience a problem within your warranty period, ship prepaid to:**

**WARRANTY CENTER
31133 Wixom Road, Wixom, Michigan 48393**



AIR TOOL WARRANTY POLICY

ONE (1) YEAR LIMITED WARRANTY *30 day over-the-counter replacement

Requirements for all warranty repairs:

- Proof of purchase - Sales receipt must accompany all repairs.
- Warranty card must be on file within 30 days from date of purchase.

K-Tool International air tools are warranted against defects in workmanship for one (1) year from the date of purchase*. We will repair or replace, at our option, any defective part or unit which proves to be defective in material or workmanship within the warranty period. Should an air tool fail within the first 30 days after purchase date, it may be returned to the place of purchase for a free replacement*. The foregoing obligation is K-Tool International's sole liability under this or any implied warranty, and under no circumstances, shall it be liable for any incidental or consequential damages.

This warranty applies to the basic tool. It does not apply to normal wear and tear on attached accessories/consumable products, such as drill chucks, backing pads for sanders, punch and die for nibblers, air hammer retainers, spray gun cups or kit accessories, etc.

*Repairs required as a result of abuse, misuse, damage or repair attempts made by others are not covered by this warranty.

Do NOT, under any circumstances, attempt to repair or make any adjustments on your tool, as this will VOID your warranty.

Suggested instructions for maximum air tool efficiency:

- Your tool should be oiled daily when in use with a non-detergent type oil. Manufacturer recommends 4 - 5 drops of type A transmission oil or air tool oil be applied through the rear inlet. If possible, a fog type oiler is recommended.
- Check your compressor daily for excess water. Moisture greatly affects the efficiency of tool operation and may void warranty.
- Use recommended air pressure (not to exceed 90 psi). For maximum performance, air compressor must be capable of maintaining approximately 90 psi.
- 3/8 air hose and fittings are recommended for optimum operation of tools. 1/2 air hose for 3/4 or 1 impact wrenches is required to maximize performance.
- An oil/water extractor is necessary for spray guns.

Notice: Warranty repair will not be performed on a spray gun that has not been cleaned. Item must be cleaned before it is sent for repair, or spray gun will be returned collect, with no repairs performed.

Should you experience a problem within your warranty period, ship prepaid to:

**WARRANTY CENTER
31133 Wixom Road, Wixom, Michigan 48393**



SAFETY INFORMATION

For your safety, please read and understand the following safety guidelines.

Never misuse a tool. Improper use of a tool will shorten its life.

ALWAYS wear safety goggles to protect eyes. Keep your tools clean.

Never use a broken tool. Keep all tools out of the reach of children.

AccuTorq®:

Wear protective goggles. Never hold with hands while tightening. Never use torque sockets to remove lug nuts. When tightening lug nuts, use the criss-cross wheel nut tightening sequence.

Grinders, Grinding Wheels and Air Tool Accessories:

Wear protective goggles. Do not operate power tools at speeds that exceed their maximum rated rpm. Power tool accessories can break, causing particles to fly. Avoid injury by using eye shields and guards.

Hammers:

Wear protective goggles. Always use a hammer that is suitable for the job. Head diameter should always exceed the object being struck, such as a punch or chisel. Do not strike a tool that shows distress.

KTIp.s.t.® TPMS Activation Tool

Product emits magnetic and electromagnetic waves that may interfere with the safe operation of pacemakers. Individuals who have pacemakers should never use this product. Do not use any harsh chemical solvents to clean tool. Do not use tool where contact or immersion in water is possible. Never spill liquid of any kind on the tool. Do not use or store the tool where it is exposed to direct sunlight or excessive moisture. Do not operate tool in the vicinity of open containers or flammable liquids. Do not operate tool with battery cover removed.

Lifting Equipment:

Do not exceed the rated capacity of jack or jack stands. Use jacks only on strong level surfaces. Collapse of lifting equipment can cause serious injury. Do not work on a vehicle supported by a jack, use jack stands.

MEGAHAMMER®:

Lock nut on hub removal tool must be tight to protect against thread damage. Slide shaft thread to be engaged into base plate thread so it is flush with inside edge of base plate thread. Use countersunk holes ONLY for proper grip on studs. Use outboard support to help prevent tool and wheel assembly from dropping to floor. Do not stand behind tool when in use. Tool is heavy. Use extreme caution when lifting. Keep extremities clear of pinch points. Always wear eye protection when using hub removal tool. Locking pin must be in place when not in use. Not responsible for damage to vehicle.

Pliers:

Wear protective goggles. Broken tips or cut material can fly.

Power Tools:

Wear protective goggles. Always read instructions before using a power tool. Flying particles can cause injury. Use hearing protection when exposed to noise for prolonged periods of time. Do not misuse power tools.

Prybars:

Wear protective goggles. Do not strike a prybar. Prybars may cause loose material to fly. Do not use if chipped or cracked.

Pullers:

Wear protective goggles. Be sure that center screw threads are clean and well lubricated. Be sure the puller is seated properly, do not use on an angle. Do not overstress the puller, always use the largest size possible to do the job efficiently. Never use a puller with worn or damaged parts.

Punches/Chisels:

Always wear protective goggles. Regrind a dull chisel to its original shape when the cutting edge becomes dull. Use a punch or chisel holder to prevent injury. Never use a broken punch or chisel.

Ratchets:

Ratchet mechanism may slip or break if parts are worn or dirty. Frequently clean and lubricate.

Screwdrivers:

Wear protective goggles. Never use a screwdriver for prying, punching, chiseling or scraping. Be sure tip width and thickness are appropriate for slot size.

Sockets (Hand):

Wear protective goggles. Be sure to always choose the appropriate type of socket based on its application. Do not use hand sockets on power tools.

Sockets (Impact):

Wear protective goggles. Flexible sockets and swivel joint tools rotate under power during use and should not be held. Using broken tools can cause serious injury.

Spray Guns:

Wear protective goggles.

Tie Downs/Stretch Cords:

Wear protective goggles when stretching, fastening or releasing hooks. A rebounding hook is dangerous. Do not use if product appears frayed or worn, or if the hook has been bent or otherwise tampered with. Do not stretch a stretch cord beyond 50% of its unstretched length. Do not expose to extreme stress or incorrect use. Do not exceed the maximum working load.

Tow Straps/Ropes:

Do not expose to extreme stress or incorrect use. Working load requirement should be evaluated by user before choosing the appropriate assembly. Always check anchor points. Never use if webbing is worn or frayed.

Wrenches:

Wear protective goggles. Do not over-torque. Avoid excess force on crowfoot or flare nut wrenches. Always use correct size.

